

Install & maintenance manual

# VEDA IN DRIVES

## SFT10 series soft starter



<b>Content</b>	<b>page</b>
Safety & Warning .....	3
General .....	4
Model description .....	5
Soft starter control and application .....	6
Installation .....	8
Wiring .....	9
Typical wiring .....	13
Operation interface description .....	15
Parameter description .....	16
Trouble shooting .....	20
Appendix .....	21
Mechanical installation .....	23
Typical wiring .....	24

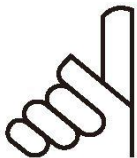

### **Caution**

Remind user caution information.



### **Warning**

If not avoided, could result in damaged to the equipment.



### **Avoid electrostatic**

Warning. It is forbidden to touch the PCB with the mark. Electrostatic charges could damage the components of soft starter.



### **High voltage warning**

If not avoided, could result in damaged to the equipment and possible injury or death.

**warning- Indicates a risk of electric shock.**

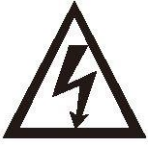

High voltage are presents at the input and output terminals of SFT10 series soft starter, even not work when connect power supply. Only qualified electricians are allowed to install these products.

**Do not carry out any work on the soft starter while the power is applied.**



The installation electricians have the responsibility to ensure correct earthing connection. Do not connect the power factor correction capacitor to the output side of the SFT10 soft starter. If the static power factor compensation measures are to be taken, the related devices must be connected to the power supply side of the soft starter.



SFT10 series soft starter is a full digital product.

Suitable for squirrel-cage asynchronous motors:

Rated voltage: 220V/400V/500V Rated power: 0.75-75KW

The SFT10 series soft starter can control the motor to accelerate smoothly during the starting process and decelerate smoothly in the process of stopping. It also provides a comprehensive protection function for motors and itself.

## Functions

- Start/stop slope and initial voltage set by 3 different potentiometers built-in
- Bypass relay built-in, No need for extra contactor
- Voltage slope startup mode
- The output torque can be maintained during the stop process (Continuous torque control), prevent water hammer effect
- External  $\Delta$ , Y Wiring mode
- Real-time data of communication (A,B,C phase current, average current) \*1
- Reading history fault records by communication (10 history log)\* 1
- The statistics data can be read by Modbus communication.\*1
- Protections:
  - 1)  $8xI_n$  overcurrent protection.
  - 2)  $5\sim 8.5xI_n$  Continued Overcurrent Protection.
  - 3) Over load Protection with classes 10A, 10, 20 and 30.
  - 4) Three phase current imbalance Protection.
  - 5) No voltage protection.
  - 6) Phase Missing Protection.
  - 7) Phase Sequence Protection.
  - 8) SCR Overheating Protection.
- 1 start/stop Digital Input
- Communication Interface. \*1
- Option Build In start/stop switch \*2
- 2 Output relay (running relay, trip relay)

Note \*1: Option, only if select the RS-485 communication interface with the function.

Note \*2: The function is available by using optional SFT10 switch on operating panel.

## Technical parameters

- Rated Main Voltage: 200-500VAC 50/60Hz
- Control Source Voltage: 100~240VAC 24VDC;
- Rated Main Current: 1.5A.....150A
- Initial voltage: 30%~70%;
- Start Slope: 1~30 Sec;
- Stop Slope: 0~30 Sec;
- Overload: 3xle 7 Sec, Valid for 50 % on time and 50 % off time.
- Times of start per hour: <5, 5-10 (light load or no-load)
- Overload grade: 10A;
- Operation Environmental temperature: 0 °C to + 50 °C (32 °F to 122 °F)
- Store temperature: -40 °C to + 70°C (-40 °F to 158 °F)
- Maximum altitude: 1000m (3280 ft)
- Ingress Protection grade: IP21;

## Model description

**SFT10-T4-0045-220V-S-MB** where SFT10 – model  
 S2 or T4 – **single phase motors** 220V or 3 phase motors 400V  
 0045 - Rated output current, A  
 24V or 220V – power supply control voltage 24V or 220V  
 S - with the "Start" button  
 MB – with ModBus

## Rated Main Power

Parameters (Type T4 for 3 phase motors)

Model	Motor power rating			Rated current	Structure	Weight
	220V Pe/kW	400V Pe/kW	500V Pe/kW	A	F	kg
SFT10-T4-0001	0.37	0.75	1.1	1.5	A	1
SFT10-T4-0002	0.55	1.1	1.5	2.2	A	1
SFT10-T4-0003	0.75	1.5	2.2	3	A	1
SFT10-T4-0004	1.1	2.2	3.7	4.5	A	1
SFT10-T4-0007	1.5	3.7	5.5	7.5	A	1
SFT10-T4-0011	2.2	5.5	7.5	11	A	1
SFT10-T4-0015	3.7	7.5	11	15	B	1.4
SFT10-T4-0022	5.5	11	15	22	B	1.4
SFT10-T4-0030	7.5	15	18.5	30	C	2.4
SFT10-T4-0037	11	18.5	22	37	C	2.4
SFT10-T4-0045	15	22	30	45	C	2.4
SFT10-T4-0060	18.5	30	37	60	C	2.4
SFT10-T4-0075	22	37	45	75	C	2.4
SFT10-T4-0090	25	45	55	90	D	5
SFT10-T4-0110	30	55	75	110	D	5.2
SFT10-T4-0150	37	75	90	150	D	5.2



## Rated Main Power

Parameters (Type S2 for ONE phase motors)

Model	Motor power rating		Rated current A	Structure F	Weight kg
	220V Pe kW	400V Pe kW			
SFT10-S2-0002	0.37	0.55	2	A	0.8
SFT10-S2-0003	0.55	0.75	3	A	0.8
SFT10-S2-0004	0.75	1.1	4	A	0.8
SFT10-S2-0006	1.1	1.5	6	A	0.8
SFT10-S2-0009	1.5	2.2	9	A	0.8
SFT10-S2-0012	2.2	3.7	12	A	0.8
SFT10-S2-0020	3.7	5.5	20	A	0.8
SFT10-S2-0030	5.5	7.5	30	C	2

## Rated Main Voltage

The rated main voltage of SFT10 is 220V/400V/500V.  
More detail please check the above-mentioned parameters.

## Control Source Voltage

Code	Control Source Voltage
220V	100~240VAC
24V	24VDC

## Internal Control Diagram

1. T4 (Only Use For Three Phase Motor);

2. S2 (Only Use For Single Phase Motor);

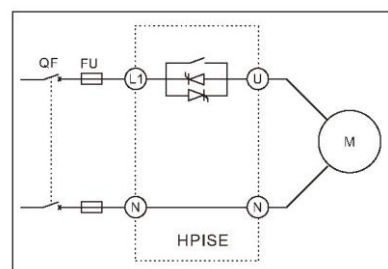
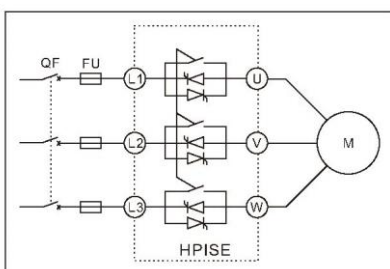

## Options

SFT10 Soft starter provides two options for users:

- communication option (option 1)

RS-485

The RS-485 option of soft starter can support MODBUS-RTU communication protocol.

- Build In start/stop switch (option 2)

The operation panel of soft starter can be equipped with start / stop switch, and users can use the switch to operate motor start / stop directly.

## Model selection

For example: Choose a 400V, 7.5KW soft starter with control source voltage of 220VDC

The type should be: SFT10-T4-0015-220V

If a built-in start / stop switch is needed

The type should be: SFT10-T4-0015-220V-S

If a communication option and built-in start / stop switch are needed

The type should be: SFT10-T4-0015-220V-S-MB

## Model selection specification

- 1) For ordinary loads  
The corresponding SFT10 soft starter models can be selected according to the rated current of motors marked on the motor nameplate, such as pumps, compressors, etc.
  - 2) For heavy load  
SFT10 soft starter model of larger power size can be selected according to the rated current of motor nameplate, such as centrifuge, crushing machine, mixer, blender, etc.;
- ◆ Frequent start  
For frequent starting loads. According to the rated current of the motor marked by the motor nameplate, we choose a higher power size SFT10 soft starter.
  - ◆ Caution:
    - 1) When the ambient temperature is higher than 40 degrees, the current rating increases by 1 degrees, and the current rating decreases by 0.8%.
    - 2) When altitude is above 1000m, decrease as below:

$$I_n = 100 - \frac{x-1000}{150}$$

When the altitude is 2000m:

$$I_n = 100 - \frac{2000-1000}{150} = 93.3\%$$

The rated current capacity of soft starter should decrease to 93.3% of nominal current.

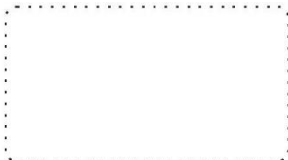

## Mechanical installation (The method of installation)

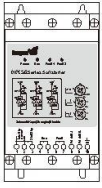

Usually, we suggest that the soft starter should be installed vertically, which is good for heat dissipation.

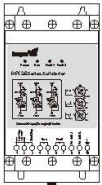

When two or more than two soft starters are installed vertically stacked, the distance between soft starters is not less than 100mm.

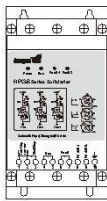
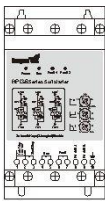
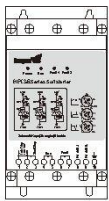
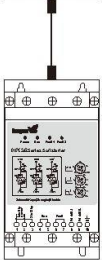

When two or more than two soft starters are installed horizontally side by side, the distance between soft starters is not less than 50mm.

## Installation environment

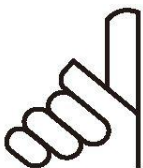

### Caution

- Do not install the soft starter near the heat source.
- Soft start must be reliably grounded, and avoid dust or corrosive environment.
- Working temperature under rating 0 ° C to + 50 ° C (32 ° F to 122 ° F)
- Relative humidity is less than 95%;

## Installation environment

The rated loss power of the soft starter approximately about

Power Dissipation  $\approx 3 \times I_e$  (W)  
 $I_e$  - Motor Rated Current (A)  
 Installed in a metal cabinet without ventilation  
 Area(m<sup>2</sup>) > 0.12 × Power Dissipation



## Main Circuit

SFT10 soft starter support two kinds of wiring modes.

### Wiring for three-phase motor

SFT10-T4-XXXX-XXX Main circuit wiring diagram (T4 soft starter)

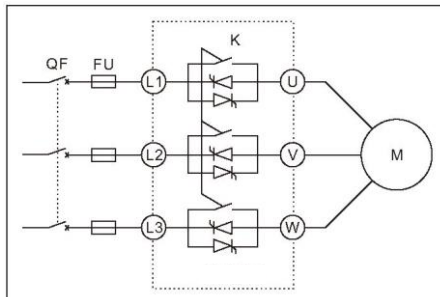

### Wiring for single-phase motor

SFT10-S2-XXXX-XXX Main circuit wiring diagram (S2 soft starter)

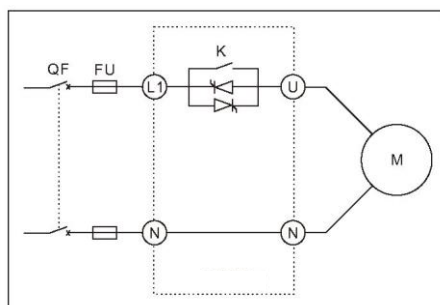

### Caution

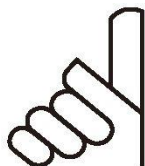

- QF Circuit breaker A circuit breaker with a tripping device is recommended.
- FU fuse Recommended installation, Selection of fuses based on SCR More detail in the appendix 11 on page 13.
- K Built-in By pass relay.
- M Motor.



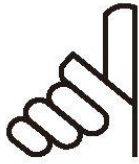

### Caution

- Suggested that a circuit breaker with a tripping device is installed between input of the soft starter and the connection of the power source. The connection between the soft starter and the power source must be switch off before maintenance.

### Main circuit terminal

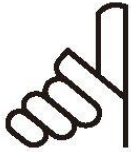

### Caution

- Suggested to use flame retardant copper core PVC insulated wire to connect main circuit.

## Main circuit terminal

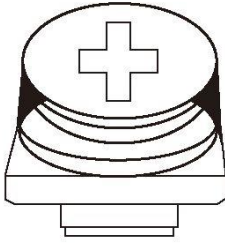

Main circuit terminal:  
Recommended use: 6-50mm<sup>2</sup> AWG: 10-1/0  
Recommended torque: 4N.m

## Control terminal

Control terminal diagram

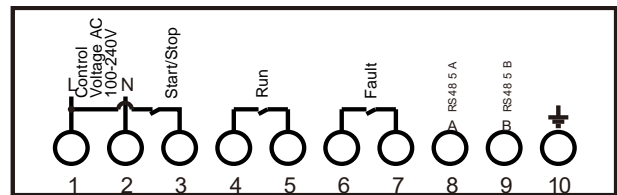
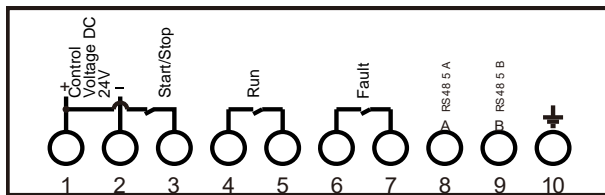

### 10 input/output terminals:

- ① Control power L or + input.
- ② Control power N or - input.
- ③ Start / Stop signal input. When terminal 3 is connected to terminal 1 the starter runs.  
When the terminal 3 and terminal 1 are disconnected, the stop softly until stop completely.
- ④ Running signal relay output.  
When the soft start is in start, bypass and soft stop state, relay operation is closed.
- ⑤ Running relay output common.
- ⑥ Fault relay output. When the soft start is in a fault state, the relay is closed.
- ⑦ Fault relay output common.
- ⑧ RS-485 bus A-LINE.
- ⑨ RS-485 bus B-LINE.
- ⑩ Earthing terminal.



## Control power supply and control Input

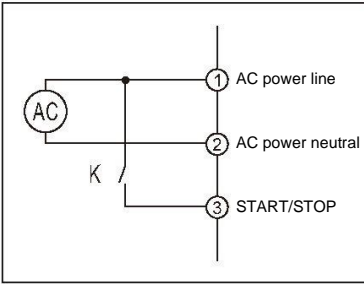

When using 100~240VAC as a control power, ①Connect AC power line, ②Connect AC power neutral; Join the contact K between ①and ③, Soft starter runs when K closed, soft starter stops when K disconnected;

If the control input cable too long or unseparated wiring with power supply, cause input signal with "induced voltage" Please add a relay at the input, so as to avoid the " induced voltage " which leads to malfunction or damage of the soft starter.

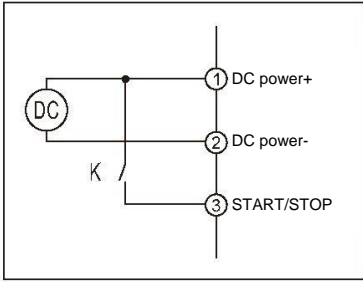

When using 24VDC as control power.

①connect to DC+, ②connect to DC-;

Join the contact K between ①and ③,

Soft starter runs when K closed, Soft starter stops when K disconnected; If the control input cable too long or unseparated wiring with power supply, cause input signal with "induced voltage" Please add a relay at the input, so as to avoid the " induced voltage " which leads to malfunction or damage of the soft starter.

### Caution

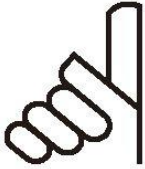

- The control power supply voltage must be matched the products, otherwise the input of the control voltage will exceed the range, which will lead to soft starter damage.
- When the control power supply is DC power, the positive and negative pole must be connected to the correct terminal.

## Relay output

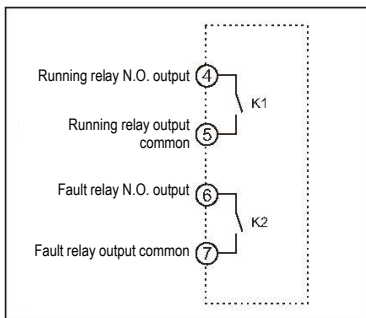

④, ⑤terminal for running relay output,

When SFT10 soft starter is on running (start / bypass / soft stop),

K1 closes.⑥⑦terminal is fault relay output,

When the SFT10 soft starter detects a fault, K2 closes.

K1, K2 contact capacity 220VAC 5A

### Caution

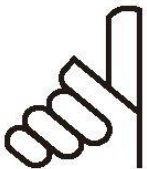

- In order to use the SFT10 soft starter safely, The fault relay K2 should be connected in the circuit of the control (release) of the circuit breaker between the power source and the SFT10 main power terminal. When the soft starter detects the fault, the K2 action can disconnect the power breaker at the same time.

## Y Wiring Mode

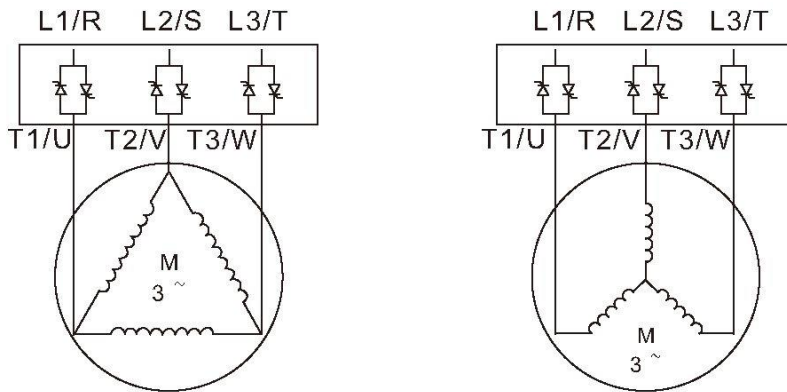

When using the external mode of SFT10, the SFT10 power module is connected between the power source and the motor.

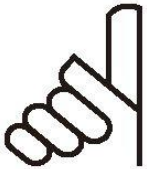

### Caution

- The motors with three terminals can only use the external wiring mode. The rated current of the soft starter in the external mode is selected according to the rated current of the motor.



## SFT10 soft starter rated current

Model	Motor power rating			Rated current	Structure	Weight
	220V Pe/kW	400V Pe/kW	500V Pe/kW	Ie A	F	kg
SFT10-T4-0001	0.37	0.75	1.1	1.5	A	1
SFT10-T4-0002	0.55	1.1	1.5	2.2	A	1
SFT10-T4-0003	0.75	1.5	2.2	3	A	1
SFT10-T4-0004	1.1	2.2	3.7	4.5	A	1
SFT10-T4-0007	1.5	3.7	5.5	7.5	A	1
SFT10-T4-0011	2.2	5.5	7.5	11	A	1
SFT10-T4-0015	3.7	7.5	11	15	B	1.4
SFT10-T4-0022	5.5	11	15	22	B	1.4
SFT10-T4-0030	7.5	15	18.5	30	C	2.4
SFT10-T4-0037	11	18.5	22	37	C	2.4
SFT10-T4-0045	15	22	30	45	C	2.4
SFT10-T4-0060	18.5	30	37	60	C	2.4
SFT10-T4-0075	22	37	45	75	C	2.4
SFT10-T4-0090	25	45	55	90	D	5
SFT10-T4-0110	30	55	75	110	D	5.2
SFT10-T4-0150	37	75	90	150	D	5.2

## Fuse table



Model	SCRI <sup>2</sup> T(A <sup>2</sup> S)	Fuse Value
SFT10-T4-0001	70	5A
SFT10-T4-0002	150	10A
SFT10-T4-0003	270	10A
SFT10-T4-0004	610	16A
SFT10-T4-0007	1700	25A
SFT10-T4-0011	3630	32A
SFT10-T4-0015	5000	40A
SFT10-T4-0022	7500	50A
SFT10-T4-0030	10000	63A
SFT10-T4-0037	11000	100A
SFT10-T4-0045	12000	160A
SFT10-T4-0060	15000	200A
SFT10-T4-0075	18000	250A
SFT10-T4-0090	40000	315A
SFT10-T4-0110	60000	315A
SFT10-T4-0150	100000	400A

## Caution

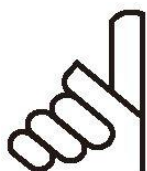

- Using semiconductor protection fuse can achieve 2nd standard, and reduce the risk of power module damage caused by transient overload current.
- 2nd standard: Under the condition of short circuit, the short circuit protection electric does not cause harm to the personal and installation equipment, and it can continue to be used.

## SFT10 soft starter panel diagram

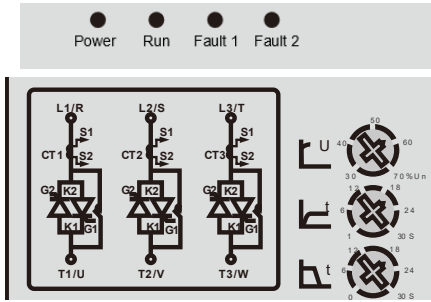

1) State display LED: Show the working state of the soft starter.

power (green)	When the soft starter is power on, the power supply LED on.
Run (yellow)	When the soft starter (motor) stop, running LED off.
	When soft starter (motor) is in soft start / soft stop state, running LED blink.
	When the soft starter (motor) is in bypass state, running LED on
Fault 1 (red)	When the soft starter is in fault state, fault LED blink or on.
Fault 2 (red)	More details please check the page 18.

2) Potentiometer setting

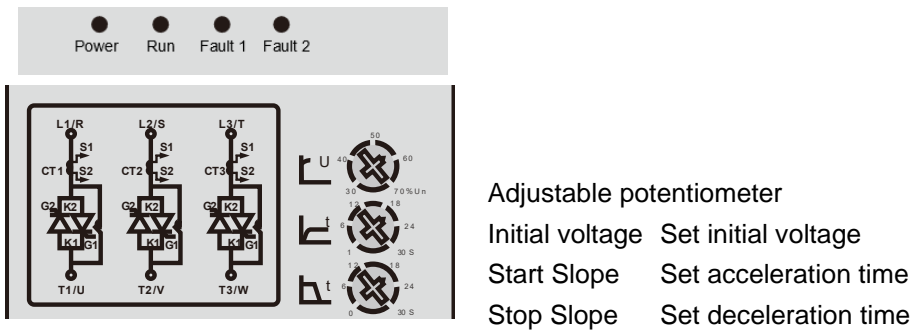

## Parameter setting

The main starting / stopping parameters of SFT10 soft starter can be set by the panel potentiometer. Other parameters have been set up at factory commissioning, users do not need to set them. Other parameters can be adjusted by RS485 communication.



**main parameter**

Parameter	Setting range	Default
FLC Full load current	0-100	Primary current of current transformer, factory setting

Parameter	Setting range	Default
FLA Full load current	0-100	Primary current of current transformer, according to rated current of soft starter factory setting

**Protection parameters**

Parameter	Setting range	Default
Over current protection value	500-850%	500%, Factory setting

Parameter	Setting range	Default
Over current trip delay time	0.1~1.0Sec.	0. 1 Sec. Factory setting

**Caution**

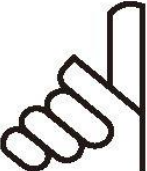

- SFT10 has two different levels of over current breaking protection.
  - 1) When the current is greater than 850% soft starter rated current (FLA), the soft starter will trip immediately. Fault relay (K2) tripped.
  - 2) When the output current is greater than the over current protection set value (the motor rated current FLA 500%-850%) the soft starter is delayed for a period of time ("over current action delay time" specified time) then trip, the fault relay (K2) tripped.

Parameter	Setting range	Default
Over load protection	100~200%	110%., Factory setting

Parameter	Setting range	Default
Overload protection grade	0-Grade 10A 1-Grade 10 2-Grade 20 3-Grade 30	0-Grade 10A Factory setting

**Caution**

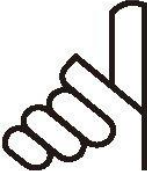

- Thermal protection of SFT10 motor.  
It is recommended that users set overload protection to (level 10A).  
When the setting less than "overload protection value", the soft starter detect overload protection.



Parameter	Setting range	Default
Phase sequence protection	0-OFF 1-ON	1-ON

The parameter setting protection functions not introduced above:

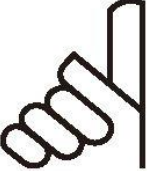
<b>Caution</b>
 <p>More protections of SFT10:</p> <ol style="list-style-type: none"> <li>1) Overtemp protection. When the heatsink temperature is above 80 degrees, the soft start trip.</li> <li>2) When the soft starter input terminal/output terminal missing phase, the soft start trip.</li> <li>3) When the power module is short circuited, soft start tripped.</li> <li>4) when the three-phase current of the soft starter is unbalanced (three-phase current difference &gt; 20%FLA), soft starter trip.</li> </ol>

**Start / stop parameters**

Parameter	Setting range	Default
Starting time	1-30 Sec.	Panel potentiometer setting or check the page 20.

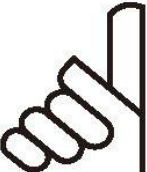
<b>Caution</b>
 <p>The starting time is set through the panel or the communication.</p>

Parameter	Setting range	Default
Stop time	0-30 Sec.	Panel potentiometer setting or check the page 20.

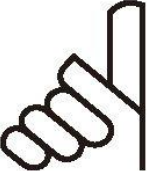
<b>Caution</b>
 <p>The stop time is set through the panel or the communication.</p>

Parameter	Setting range	Default
Initial voltage	30-70%	Panel potentiometer setting or check the page 20.

--



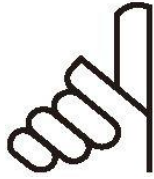

### Caution

The initial voltage is set via the panel or communication.  
When the initial turn Moment = initial voltage  $2 \times T_N$  ( $T_N$ : rated torque)

### Voltage slope starting mode

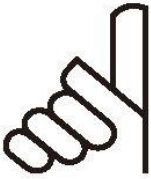
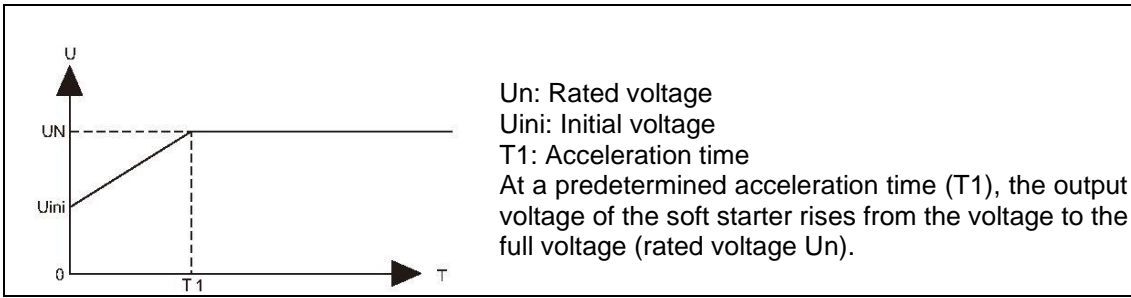

#### Caution

- The motor can't start (Locked-Rotor) if the voltage is too low. It is suggested that set initial voltage from high to low or use the Recommended setting.

### Relay parameters

Parameter	Setting range	Default
Bypass relay type	0-Electric self holding relay 1-Magnet self holding relay	Depending on the specific model Factory setting

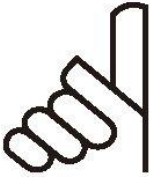

#### Caution

- The type of bypass relay is not allowed to be changed!

### Communication parameters

Parameter	Setting range	Default
Slave machines address	1~127	1, Factory setting

Parameter	Setting range	Default
Baud rate	0-1200BPS 1-2400BPS 2-4800BPS 3-9600BPS 4-19200BPS	3-9600BPS Factory setting

Parameter	Setting range	Default
Parity check	0-ECC 1-ODD 2-None	0-ECC

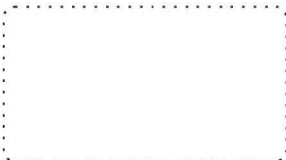

### Caution



- After setting up the communication parameters must restart the SFT10 soft starter. Incorrect settings cause communicate fault, it could cause cannot setting again. SFT10 cannot restore the default parameter, so please be careful when setting communication parameters.

### Fault list

Fault	Fault reason	Not working	Start/stop process	Bypass
Phase sequence trip	The sequence of three phase voltage is wrong	×	√	√
Missing phase trip	Missing one phase or two-phase voltage in three phase voltage	×	√	√
No voltage trip	NO voltage input	×	√	√
Over current trip	Current value exceeding over current setting value	√	√	√
Over load trip	Current value exceeds overloading set value	×	×	√
Unbalanced current trip	The unbalanced three-phase current is larger than the unbalanced current setting value	√	√	√
Overtemp trip	The temperature of the heatsink is higher than the temperature setting value	√	√	√

Note: ×: Networking; √: working

### Fault solution

Fault	Fault 1	Fault 2	Fault reason	Solution
Phase sequence trip	⊗	○	The sequence of three phase voltage is wrong	Change the sequence of three phase.
Missing phase trip/No voltage trip	○	⊗	Missing one phase or two-phase voltage in three phase voltage /NO voltage input	The connection between the soft start and the main power supply is open.
Over current trip	○	●	Current value exceeding over current setting value	Check whether the connection between soft start and motor is short circuited.
Over load trip	●	○	Current value exceeds overloading set value	Check whether the load is too large or whether the selection of soft starter power is too small.
Unbalanced current trip	●	⊗	The unbalanced three-phase current is larger than the unbalanced current setting value	Check the winding of the motor and the connection between soft starter and motor
Overtemp trip	⊗	●	The temperature of the heat sink is higher than the temperature setting value	Check whether the connection between soft start and motor is short circuited. Check whether the load is too large or whether the selection of soft starter power is too small.

⊗ Blink; ● On; ○ OFF

1. The frequency protection is built-in, SFT10 can work with 50/60HZ voltage.
2. The single-phase soft starter have no unbalanced current trip, but have no voltage trip.

**Electronic overload and tripping curve**

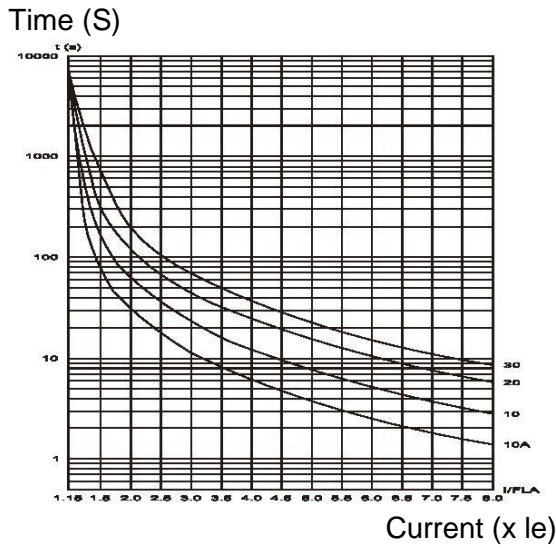

A Class 30; B Class 20  
C Class 10; D Class 10A

**Overload time**

$$\text{Overload trip time} = \frac{1375000}{I\%^2 - 110^2} \times \frac{T_x}{6}$$

**Among:**

I% is the ratio of the actual current to the rated current  
tolerance time of T \* 500% overload current (X=5)  
Minimum overload tolerance time

Overload grade	Minimum overload tolerance time						
	X=8	X=7	X=6	X=5	X=4	X=3	X=2
10A	1.6	2	3	4	6	12	26
10	3	4	6	8	13	23	52
20	5	6	9	12	19	35	78
30	7	9	13	19	29	52	112

**Parameter setting list**

Parameter	Setting range	Default
FLC Soft starter full load current	1-100A	Factory setting
FLA Motor full load current	1-100A	According to the power of soft starter.
Connection mode	0-External wiring 1-Internal wiring	0-External wiring
Over current protection value	500%-850% FLA	500% FLA
Over current trip delay time	0. 5... 1 Sec	1 Sec.
Over load protection value	100-200%FLA	115% FLA
Overload protection grade	0-Grade 10A 1-Grade 10 2-Grade 20	0-Grade 10A



Parameter	Setting range	Default
	3-Grade 30	
Phase sequence protection	0-OFF 1-ON	1-ON
Starting time	1-30 Sec.	Panel potentiometer setting
Stop time	0.5... 10秒	Panel potentiometer setting
Initial voltage	10... 50%FLA	Panel potentiometer setting
Bypass relay type	0-Electric self holding relay 1-Magnet self holding relay	Depending on the specific model
Slave machines address	1-127	1
Baud rate	0-1200BPS 1-2400BPS 2-4800BPS 3-9600BPS 4-19200BPS	3-9600BPS
Parity check	0-ECC 1-ODD 2-None	0-ECC

### Common load and parameter setting

#### 1) Slope starting mode

Load	Start time	Stop time	Initial voltage
Boat propeller	15	0	45%
Centrifugal fan	15	0	45%
Centrifugal pump	15	5	45%
Piston compressor	15	0	45%
Rotary converter	15	0	45%
Mixer	20	0	45%
Crusher	20	0	45%
Spiral air compressor	15	0	45%
No-load motor	15	0	45%
Band conveyor	15	0	45%
Hot water pump	15	5	45%
Air pump	15	0	45%

SFT10 1.5-11A  
Model A

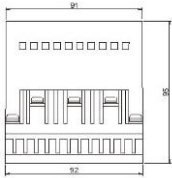

SFT10 15~22A  
Model B

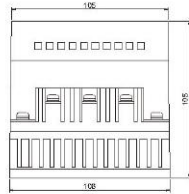

SFT10 30~75A  
Model C

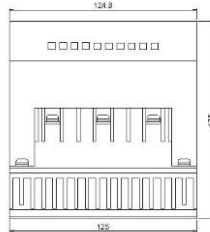

SFT10 90~150A  
Model D

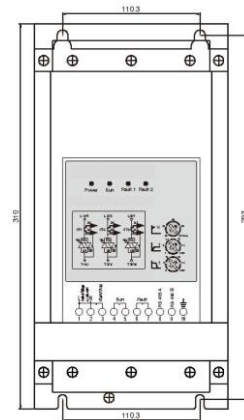
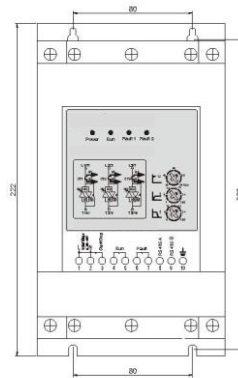
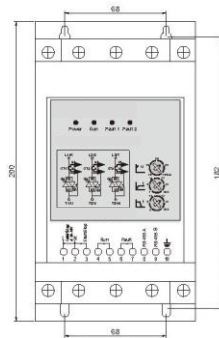
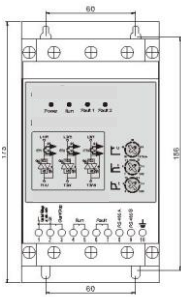
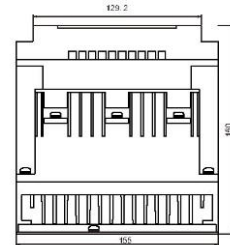

**Dear customer:**

After receiving the products sent by our company, please do not install and run directly. First, it should make a simple test according to the wiring drawings of experimental methods and steps provided by our company. After ensuring the operation of the soft starter, the wiring of the cabinet and motor correct. Then the test of whole system can be carried out.

**Test steps:**

1. Connect 3 200W/220V lamps (H1~H3) with Y connection then connect to the output of the soft starter U, V and W, and also can test by connect the small motor.
2. Close the QF1, connect the 380V AC to R, S and T of the soft starter's input terminal
3. Close the QF2 to make the 220V control power connect to the control terminals 1 and 2 of the soft starter.
4. Soft start: closed knob switch K1 (connect terminal 1, 3), bulb slowly lighten up. After the bulb is bright up, the bypass KM closes the soft start process.
5. Soft stop: disconnect K1 (disconnect terminal 1, 3), bypass KM disconnect, bulb slowly extinguish, after bulb is completely off, soft stop process is completed.

\*If the above experimental steps can not be carried out normally, we can preliminarily judge that the soft starter has been damaged.  
For more details, please contact the technical service department.

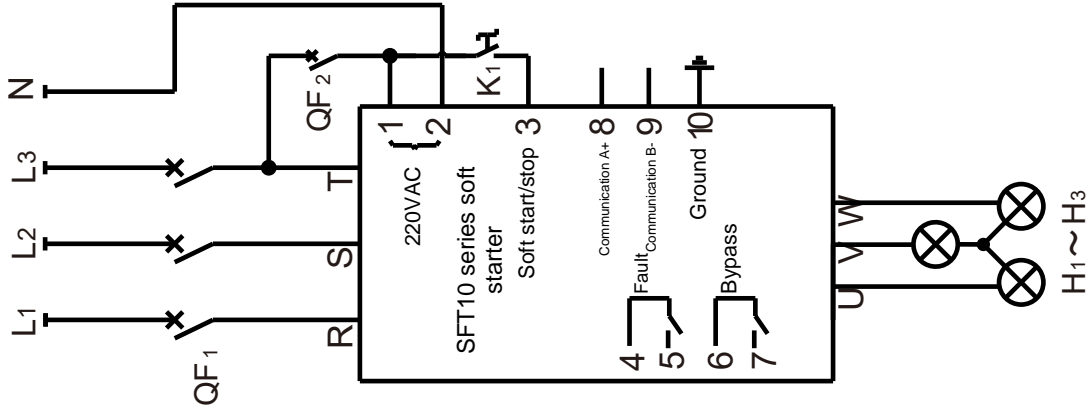

Technical service department:  
E-mail: [tech@vedaindrives.com](mailto:tech@vedaindrives.com)

Basic parameter setting	
Overload Trip	10
Start	8~12S
Stop	2~4S
UINI	50%



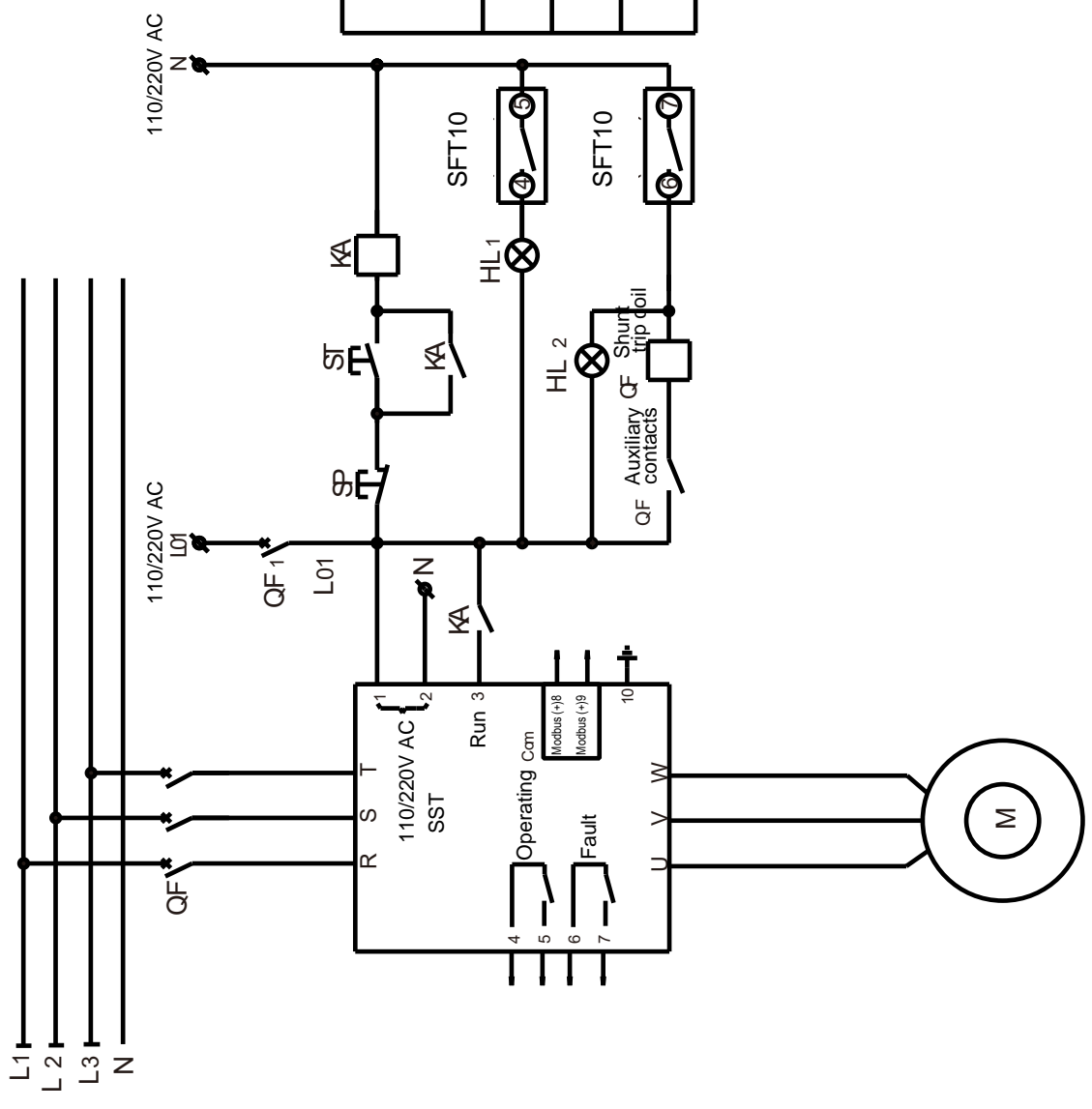
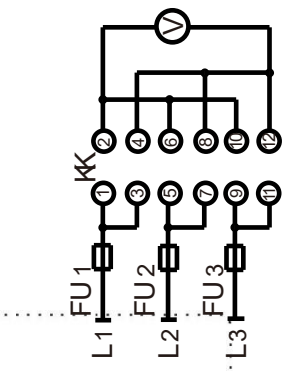

On/Off
Run
Fault
Power

Code	Name
QF	Breaker
QF <sub>1</sub>	Breaker
FU <sub>1</sub> ~FU <sub>3</sub>	Fuse
SST	Soft starter
ST, SP	Button
HL <sub>1</sub> ~HL <sub>2</sub>	Signal lamp
KK	Switch
V	Voltmeter
KA	Auxiliary relay

VEDA-IN DRIVES

SFT10 three-phase softstarter schematic diagram

Diagram  
SL-1801

Copy right reserved.

The manufacture reserves the right to change specification of the products without notice.