

VEDA^{IN}DRIVES

Technical manual

for frequency converters VEDA-in RD05 series

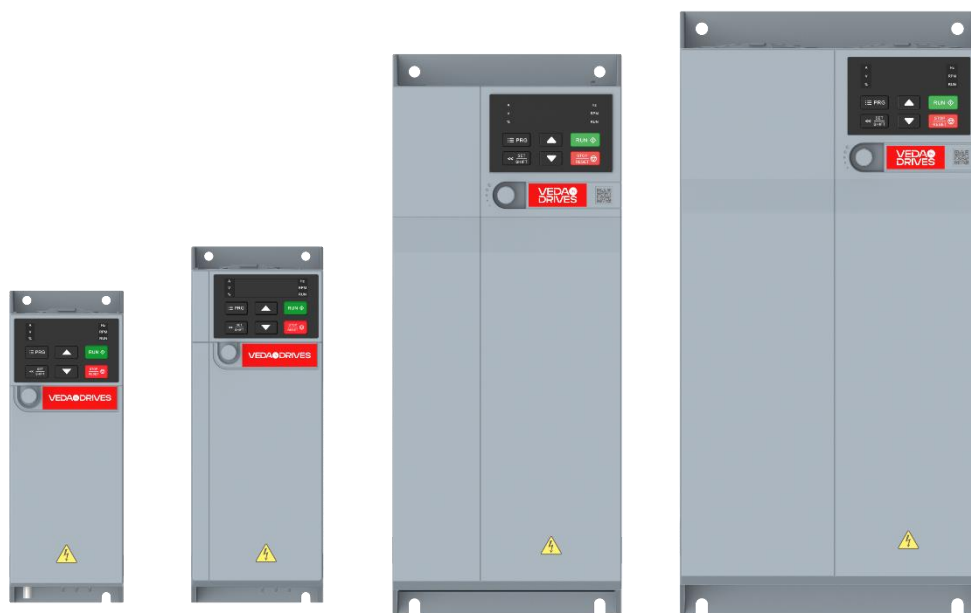

Quick directory

How to conduct motor self-tuning

When the motor is running, the motor related parameters are automatically learned and set.

⇒ Section 4.8 Self-tuning

How to diagnose faults

When a warning or fault is displayed on the keyboard

⇒ Section 6.2 Fault, warning, prompt code type

When no alarm or fault is displayed on the keyboard

⇒ Section 6.7 Troubleshooting without prompting on the keyboard

How to choose

Inverter model and nameplate

⇒ Section 2.2 Inverter model and nameplate

Installation size

⇒ Section 3.4 Dimensions

Parameter profile

⇒ Chapter 10 Parameter List

Detailed description of the parameters

⇒ Chapter 11 Parameter Details

Contents

Quick directory	I
Contents	III
1 Preface and Precautions	1
1.1 Before Using	1
1.2 Safety Instructions	1
1.3 Special Use Instructions	3
2 Before Use	4
2.1 Safety Notes	4
2.2 Inverter model and nameplate	4
2.3 Frequency Inverter Technical Specifications	5
2.4 Inverter rated output current	6
2.5 Inverter Default Acceleration and Deceleration Time	6
2.6 Inverter Default Voltage Protection Point	6
2.7 Types and Characteristics of Control Modes	7
3 Installation and Wiring	8
3.1 Safety Precautions	8
3.2 Installation Environment	8
3.3 Installation Direction and Space	9
3.4 Dimensions	10
3.5 Standard Wiring	11
3.6 Main Circuit Wiring	14
3.7 Control Circuit Wiring	15
3.8 Set the Braking Resistor	16
3.9 Standby Control System	17
4 Basic Operation and Trial Run	18
4.1 Safety Precautions	18
4.2 Keyboard Layout and Functions Specification	18
4.3 LED Status Indicator	20
4.4 Initial Startup Step	20
4.5 Confirmation at the Time of Initial Startup	23
4.6 Keyboard Operation Method	24
4.7 Self-tuning	24
4.8 Trial Run	25
4.9 Precision Adjustment during Trial Running (Control Performance Optimization)	26
5 Network Communication	27
5.1 Safety Precautions	27
5.2 MODBUS Communication	27
6 Troubleshooting	32
6.1 Safety Precautions	32
6.2 Fault, warning, prompt code type	33
6.3 Fault, Warning, Prompt Code List	33
6.4 Fault	35
6.5 Warning	41
6.6 Fault reset method	43
6.7 Troubleshooting without prompting on the keyboard	43
7 Overhaul and Maintenance	45
7.1 Safety Precautions	45
7.2 Overhaul	45
7.3 Maintenance	46
7.4 Replace the cooling fan	47
7.5 Replace the inverter	47
7.6 Custody essentials	47
8 Scrap	48
8.1 Safety Precautions	48
8.2 Precautions related to scrapping	48
9 Peripheral Equipment and Options	49
9.1 Safety Precautions	49
9.2 Peripheral Equipment	49
9.3 The use of peripheral equipment	50
10 Function Table	53
10.1 Safety Precautions	53
10.2 Reading Method of Parameter List	53
10.3 Functional Group	53
10.4 Group F00: Environmental Applications	55
10.5 Group F01: Basic Settings	56
10.6 Group F02: Motor 1 Parameters	59
10.7 Group F03: Vector Control	60
10.8 Group F04: V/F Control	63

10.9 Group F05: Input Terminal.....	65
10.10 Group F06: Output Terminal.....	69
10.11 Group F07: Operation Control.....	72
10.12 Group F08: Auxiliary Control.....	75
10.13 Group F09: Reserved.....	76
10.14 Group F10: Protection Parameters.....	76
10.15 Group F11: Operator Parameters.....	81
10.16 Group F12: Communication Parameters.....	84
10.17 Group F13: Process PID Control.....	85
10.18 Group F14: Multi-Speed and Simple PLC.....	87
10.19 Group F15: Reserved.....	90
10.20 Group C0x: Monitoring Parameters.....	90
10.21 Communication Variable Group.....	93
11 Parameter details.....	95
11.1 Safety Precautions.....	95
11.2 F00 Group: Environmental Applications.....	95
11.3 F01 Group: Basic Settings.....	98
11.4 F02 Group: motor 1 parameters.....	108
11.5 F03 Group: Vector Control.....	111
11.6 F04 Group: V/F Control.....	118
11.7 F05 Group: Input terminal.....	122
11.8 F06 Group: output terminal.....	135
11.9 F07 Group: Operation Control.....	145
11.10 F08 Group: Auxiliary Control 1.....	153
11.11 F09 Group: Reserved.....	156
11.12 F10 Group: Protection parameters.....	156
11.13 F11 Group: keyboard parameters.....	166
11.14 F12 Group: Communication parameters.....	171
11.15 F13 Group: Process PID Control.....	174
11.16 F14 Group: multi-speed and simple PLC.....	180
Revised record.....	187

1 Preface and Precautions

1.1 Before Using

About the terms in this book, the abbreviation

Marked in the manual	Description
Frequency inverter	RD05
AM-VF	Asynchronous-VF control
AM-FVC	Asynchronous - no PG vector control
Bit	Bit in binary number

1.2 Safety Instructions





Thank you for purchasing the RD05 series vector control inverter designed and manufactured by Flextronics. This manual describes how to use this product correctly for good returns. Please read this manual carefully before using the product (installation, wiring, operation, maintenance, inspection, etc.). In addition, please use this product after fully understanding the safety precautions described in this manual.

Safety Precautions

To ensure safety, reliable and reasonable use of this product, please use the product after fully understanding the safety precautions described in this manual.

Warning sign and its meaning

The following symbols are used in this manual to indicate that it is an important part of safety. Failure to follow these precautions may result in personal injury or death, damage to this product and associated systems.

 Danger	DANGER: Death or major safety hazard can result from incorrect operation.
 Warn	WARNING: Failure to do so may result in death or major safety hazard.
 Caution	Note: If the operation is wrong, it may cause minor injuries.
 Important	Tip: If the operation is wrong, the product and associated system may be damaged.

General Notes	
<ul style="list-style-type: none"> To illustrate the details of the product, the illustrations in this instruction manual are sometimes in the state of removing the cover or safety cover. When using this product, be sure to install the cover or shield as required and follow the instructions in the instruction manual. The illustrations in this User's Guide are representative examples only and may differ from the products you ordered. This User's Guide is subject to change without notice due to product improvements or specification changes, and to improve the convenience of the User's Guide. When you need to order this book due to damage or loss, please contact our nearest sales office on the back cover of the company or the back cover and inform the cover number. 	

DANGER

Please pay attention to all the information about safety in this book.

If you do not follow the warnings, you may cause death or serious injury, so please pay attention. The company will not be responsible for any damage or equipment damage caused by your company or your company's customers who fail to comply with the contents of this book.

In order to prevent electric shock

Do not perform inspection or wiring work while the power is on. Be sure to turn off the power to all machines before wiring or repair work. Even if the power is turned off, there is residual voltage in the capacitor inside the inverter. To prevent electric shock, at least wait for the time specified on the warning label on the front panel of the unit. After the indicators are all off, remove the front cover and terminal cover, measure the input supply voltage and the main circuit DC voltage, and confirm that it is below the safe voltage.

WARNING

For mechanical safety

After the wiring operation and parameter setting are completed, be sure to carry out trial operation to confirm that the machine can operate safely, otherwise it may cause injury or equipment damage.

Be sure to confirm the setting value of the parameters for the virtual input/output function before the inverter is tested.

The virtual input/output function is to make the virtual connection of the input and output terminals inside the inverter. Therefore, even if there is no wiring on the input and output terminals, the operation of the inverter may be different from the factory setting. If it is neglected, the accidental operation of the inverter may cause personal accidents.

Before turning on the inverter power supply, make sure there are no people around the inverter, motor, and machine. Also, check that the cover, coupling, shaft key, and machine of the inverter are properly protected.

Some systems may suddenly move the machine when the main circuit is energized, posing a risk of death or serious injury.

The inverter's external terminal control is used. The function of the inverter's input and output terminals will be different from the factory settings. Therefore, the operation of the inverter may be different from the factory settings described in the instruction manual. Before the inverter is tested, please use the external terminal control to confirm the input and output signals and internal sequence of the inverter.

In order to prevent electric shock

It is forbidden to modify the inverter.

If your company or your company's customers have modified the product, the company will not be responsible.

Non-electrical construction professionals should not perform wiring, installation, maintenance, inspection, component replacement or repair work.

Do not remove the cover of the inverter or touch the printed circuit board while the power is on.

To prevent fire

Do not mistake the voltage of the main circuit power supply. Before powering on, please confirm whether the rated voltage of the inverter is consistent with the power supply voltage.

Please follow the local standards and set the bypass protection circuit. Improper wiring may result in fire or personal accident.

NOTE

In order to prevent injuries

Do not carry the inverter with the front cover or terminal cover of the inverter. In addition, please confirm that the screws are properly tightened before handling.

TIPS

Use a motor that meets the insulation requirements of the PWM inverter to prevent short-circuit or short-circuit to ground due to insulation degradation. When operating the inverter or disassembling the printed circuit board, follow the steps specified in the static electricity prevention measures (ESD). If the operation is incorrect, the internal circuit of the inverter may be damaged due to static electricity.

The withstand voltage test cannot be performed on any part of the inverter. This device uses a precision instrument and may cause damage to the inverter due to high voltage.

Do not run a machine that has been damaged. If the machine is obviously damaged or parts are missing, do not connect or operate, otherwise the machine damage and other problems will increase.

Do not turn the power on or operate the machine immediately when the fuse blows or the leakage circuit breaker trips. Please check the cable wiring and the selection of the peripheral machine to find out the cause of the problem. If you are unsure of the cause, please contact us and do not switch on the power or operate the machine.

When packaging wood materials need to be disinfected or dewormed, be sure to use methods other than fumigation. For example: heat treatment (30 minutes or more at a core temperature of 56 ° C or higher) In addition, please dispose of the material before packaging, rather than treating the whole after packaging.

When electrical products (single or mechanically mounted) are packaged in fumigation-treated wood, the gases and vapors produced by the packaging may cause fatal damage to the electronics. In particular, halogen disinfectants (fluorine, chlorine, bromine, iodine, etc.) may cause internal corrosion of the capacitor, and DOP gas (phthalate) may cause cracking of the resin or the like.

1.3 Special Use Instructions

If you need to use this product for special purposes such as manned mobile, medical, aerospace, nuclear power, electric power, submarine relay communication equipment or systems, please contact our agent or sales person in charge.

2 Before Use

2.1 Safety Notes

DANGER

Please pay attention to all the information about safety in this book.

If you do not follow the warnings, you may cause death or serious injury, so please pay attention. The company will not be responsible for any damage or equipment damage caused by your company or your company's customers who fail to comply with the contents of this book.

2.2 Inverter model and nameplate

After the product arrives, please confirm the following;

- Check the appearance and check for any scratches or dirt on the inverter. If there is any damage, please contact the shipping company immediately. Damage caused by product handling is not covered by the company.
- Make sure that the model number of the drive matches the one you ordered. For the model number, please refer to the "MODEL" column on the nameplate on the side of the inverter.
- If you find that the product is in bad condition, please contact the agent of the company where you purchased the product or the person in charge of the company

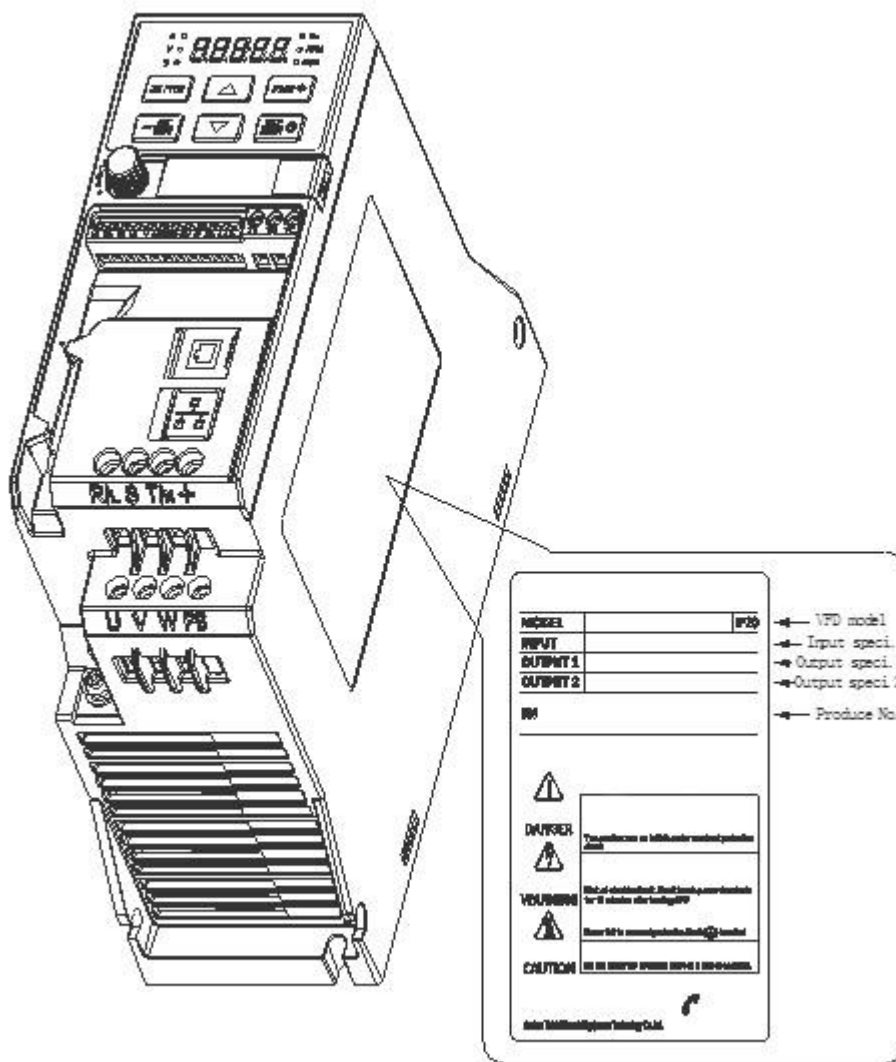

Model reference

The method for checking the model number of the inverter is shown below:

Type code decoding

Example	RD05-S2-075-IP20-BU
RD05	Product Series
S2	Voltage class S2 220V / T4 380-400V
075	Rated output current, A
IP20	Environmental protection class
BU	Brake unit integrated

2.3 Frequency Inverter Technical Specifications

Table 2-1: Technical Specifications

Items		Specification
Input	Voltage, Frequency	Single-phase 220V 50/60Hz Three-phase 220V 50/60Hz Three-phase 380V 50/60Hz
	Allow fluctuations	Voltage imbalance rate: <3%; Frequency: ±5% The distortion rate meets the requirements of IEC61800-2
	Impact current when power on	Less than rated current
	Power factor	≥0.94 (with DC reactor)
	Inverter efficiency	≥96%
Output	Output voltage	Output under rated conditions: 3 phases, 0 to input voltage, error less than 5%
	Output frequency range	0-600.00Hz
	Output frequency accuracy	±0.5% of the maximum frequency value
	Overload capability	T3 model: 150% rated current for 1 minute, 180% rated current for 5 seconds, 200% rated current for 0.5 second S2 model: 150% rated current 20 seconds, 180% rated current 0.5 seconds
Maincontrol performan-ce	Motor type	PMSM, AM
	Motor control mode	No PG V/F control, no PG vector control
	Modulation	Optimized space vector PWM modulation
	Carrier frequency	1.0~16.0kHz
	Speed control range	No PG vector control, rated load 1:100
	Steady state speed accuracy	No PG vector control: ≤ 2% rated synchronous speed
	Starting torque	No PG vector control: 150% rated torque at 0.5Hz
	Torque response	No PG vector control: <20ms
	Frequency accuracy	Digital setting: maximum frequency × ± 0.01%; analog setting: maximum frequency × ± 0.2%
	Frequency resolution	Digital setting: 0.01Hz; Analog setting: Maximum frequency × 0.05%
Basic product function	DC braking capability	Starting frequency: 0.00~50.00Hz Braking time: 0.0~60.0s Braking current: 0.0~150.0% rated current
	Torque boost	Automatic torque increase 0.0%~100.0% Manual torque increase 0.0% ~ 30.0%
	V/F curve	Four modes: linear torque characteristic curve, self-set V/F curve, torque reduction characteristic curve (1.1 to 2.0 power), square V/F curve
	Acce. / Dece. curve	Two ways: linear acceleration and deceleration, S curve acceleration and deceleration Four sets of acceleration and deceleration time, the time unit is 0.01s, the longest is 650.00s
	Rated output voltage	Using the power supply voltage compensation function, the rated voltage of the motor is 100%, which can be set within the range of 50 to 100% (the output cannot exceed the input voltage)
	Automatic voltage adjustment	Automatically keeps the output voltage constant when the grid voltage fluctuates
	Automatic energy saving operation	Automatically optimize output voltage according to load under V/F control mode to achieve energy-saving operation
	Automatic current limiting	Automatically limit current during operation to prevent frequent overcurrent fault trips
	Instant power down handling	Uninterrupted operation through bus voltage control during instantaneous power loss
Standard function	PID control, speed tracking and power-down restart, skip frequency, frequency upper and lower limit control, program operation, multi-step speed, RS485, analog output, frequency pulse output	

	Frequency setting channel	Keyboard digital setting, keyboard potentiometer, analog voltage/current terminal AI, communication setting and multi-channel terminal selection, main and auxiliary channel combination, can be switched in various ways	
	Feedback input channel	Keyboard potentiometer, voltage/current terminal AI, communication reference, pulse input X4/PUL	
	Run command channel	Operation panel reference, external terminal reference, communication reference	
	Input command signal	Start, stop, forward and reverse, jog, multi-speed, free stop, reset, acceleration/deceleration time selection, frequency setting channel selection, external fault alarm	
	External output signal	1 relay output, 1 collector output, 1 AO output can be selected as 0~10V or 4~20mA or 4~20mA output	
Protective function		Overvoltage, undervoltage, current limiting, overcurrent, overload, electronic thermal relay, overheating, overvoltage stall, data protection, fast protection, input and output phase loss protection	
Keyboard display	LED display	Single line 5-digit display	1 inverter status quantity display
		Double line 5-digit digital tube display	2 inverter status quantity display
	Parameter copy	Upload and download function code information of the inverter for fast parameter copying	
	Status monitoring	All parameters of the monitoring parameter group such as output frequency, given frequency, output current, input voltage, output voltage, motor speed, PID feedback amount, PID given amount, module temperature, etc.	
Error alarm	Overvoltage, undervoltage, overcurrent, short circuit, phase loss, overload, overheat, overvoltage stall, current limit, data protection damage, current fault operation, historical fault		
surroundings	Installation place	The altitude is less than 1000 meters, and the derating is more than 1000 meters. The derating is 1% for every 100 meters. No condensation, icing, rain, snow, sputum, etc., solar radiation is less than 700W/m ² , air pressure 70~106kPa	
	temperature humidity	-10 ~ +50° C, derating can be used above 40 ° C, the maximum temperature is 60 ° C (no-load operation) 5% to 95% RH (no condensation)	
	Vibration	At 9 to 200 Hz, 5.9 m/s ² (0.6 g)	
	Storage temperature	-30 ~ +60°C	
	Installation method	Wall-mounted, closet	
	Protection level	IP20	
	cooling method	Forced air cooling	

Note: The three-phase 220V 50/60Hz power input mode is specially described:

The RD05-S2 series inverter is designed for single-phase 220V AC voltage input; it is compatible with three-phase 220V AC input, which will cause the three-phase current imbalance of the grid R, S, T.

2.4 Inverter rated output current

Voltage	220V	380V	Voltage	220V	380V
Power(KW)	Rated output current (A)		Power(KW)	Rated output current (A)	
0.75	4	3	4		9.5
1.5	7	4	5.5		13

2.5 Inverter Default Acceleration and Deceleration Time

The default acceleration and deceleration of the inverter varies with the power level. See the following table for details:

Inverter power level (Kw)	Acceleration and deceleration time default value (s)
0.75	6.00
1.5	6.00
2.2	6.00
3.0	6.00
4.0	6.00
5.5	6.00

2.6 Inverter Default Voltage Protection Point

The default voltage value of the inverter includes rated voltage, overvoltage suppression point, overvoltage point, undervoltage suppression point, undervoltage point and energy consumption braking point, etc., as shown in the following table.

Note: The values in the table are in volts (V)

Voltage level (VAC)	Rated voltage (VDC)	Undervoltage suppression point (VDC)	Undervoltage point (VDC)	Overvoltage suppression point (VDC)	Overvoltage point (VDC)	Energy consumption braking point (VDC)
220	311.1	240	190	365	400	350
380	537.4	430	320	750	820	740

2.7 Types and Characteristics of Control Modes

The inverter can select AM-V/F control (initial setting) and AM-open loop vector control.

Asynchronous motor V/F control

- It means that when the frequency (F) is variable, the ratio of the control frequency to the voltage (V) remains constant.
- This control mode is used for all variable speed control that does not require fast response and precise speed control, as well as the use of multiple inverters with one frequency inverter. This method is also used when the motor parameters are not clear or cannot be self-tuned.

Asynchronous motor open loop vector control

- The vector can be divided into the excitation current and the torque current by performing vector calculation on the output current of the inverter, and the frequency and voltage are compensated to flow the motor current matched with the load torque to improve the low speed torque. At the same time, the output frequency compensation (slip compensation) is implemented to make the actual rotation speed of the motor closer to the speed command value.
- This control mode is used for applications requiring high speed control accuracy. High speed response and torque responsiveness, high torque output at low speeds. Suitable for general high-performance control applications, one inverter can only drive one motor.

Note :



- For best control, enter the motor parameters correctly and perform motor self-tuning. The F02.0x group is the basic parameter group of the motor.
- In the open loop control, the inverter can only drive one motor; and the inverter capacity and motor capacity can not be too different, the inverter can be two or smaller than the motor's power level, otherwise the control performance may be degraded. , or the drive system is not working properly.

3 Installation and Wiring

3.1 Safety Precautions

This chapter explains the warnings that must be followed to ensure that the user can safely use the product, maximize the performance of the inverter, and ensure reliable operation of the inverter.

Cautions in use:

 Warn	<ul style="list-style-type: none"> ● While install the inverter in the closed cabinet, please build in cooling fan, air-conditioner or other cooling equipment to ensure the temperature at the air-in port below 40°C. So that the inverter can work safely and reliably.
 Important	<ul style="list-style-type: none"> ● While installing, please use cloth or paper cover the inverter to prevent metal dust, oil, water and others. And remove it carefully after working. ● While operation, please follow the ESD regulations. Otherwise, the inverter may be damaged. ● While multi inverters are installed in the same cabinet, enough space must be left for cooling fan. ● Inverter cannot work over rated range. Otherwise, the inverter may be damaged. ● While transporting the inverter, please hold the firm case. If only hold the pre-cover, there is danger of inverter main body falling, injury or inverter damage.

Cautions in use motor

 Important	<ul style="list-style-type: none"> ● Different motor has different max allowable running speed. Motor can not run over the max allowable running speed. ● While inverter is running at low speed, the motor auto-cool effect is seriously worse. If motor runs at low speed for long time, it will be damaged for overheat. If needed, please use special motor for inverter. ● While constant speed machinery runs at inconstant speed, there maybe sympathetic vibration. Please install vibration-proof rubber under motor rack or use jumping frequency control function. ● While using frequency inverter or working frequency power supply to drive, the torque characteristic are different. Please do confirm the torque characteristic of the equipment connected. ● The rated current of diving motor is higher than that of standard motor, please confirm it and choose the right inverter. ● While the wire between motor and inverter is long, the max torque of the motor will reduce for voltage drop. So please use thick cable while the distance between the motor and the inverter is long.
---	---

3.2 Installation Environment

Installation environment is very important to the best use of this product for long time. Please install this product in the environment as the following table requirement.

Environment	Requirement
Install place	Indoor without direct sunshine
Install temperature	-10 ~ +50°C
Store temperature	-30 ~ +60°C
Humidity	<95%RH, no condensation
Surrounding	Please install the inverter in place as follows: <ul style="list-style-type: none"> ● Place without oil mist, corrosive gases, flammable gas, dust or etc. ● Place without metal dust, oil, water or etc into inverter (please do not install inverter on flammable material such as food and etc). ● Place without radioactive material or flammable material. ● Place without poisonous gases or liquid. ● Place with very little salification erosion. ● Place without direct sunshine.
Altitude	<1000m, down power for use over 1000 meters
Vibration	At 9 to 200 Hz, 5.9 m/s ² (0.6 g)
Installation and cooling	<ul style="list-style-type: none"> ● Inverter that can not be installed horizontally must be installed vertically. ● Please independently install high heating equipment such as braking resistor and etc which can not be installed in the same cabinet with inverter, installed at the air-in port of the inverter is strictly prohibited.

Table 3-1: Environmental conditions required for reliable operation of RD05 series inverters

- In order to improve the product stability, please do not use the inverter where temperature changes sharply. While using in closed space such as control cabinet, please use cooling fan or air-conditioning to cool inverter to avoid temperature over limit range. Please also prevent inverter from freeze, too low temperature may cause components freeze fault.
- Derate according to the chart while over temperature limit.

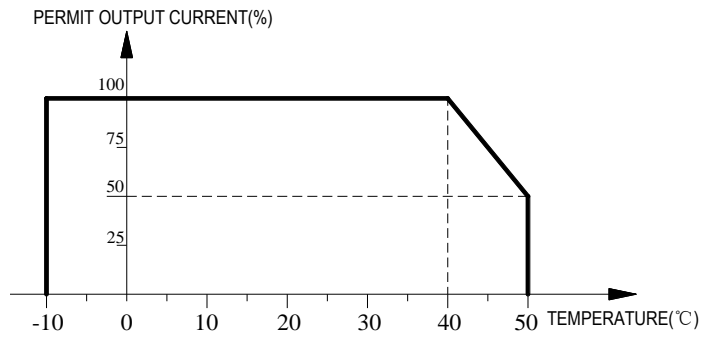

Chart 3-2: RD05 series inverter derating curve while over permit temperature

- Derate according to the chart while over altitude limit.

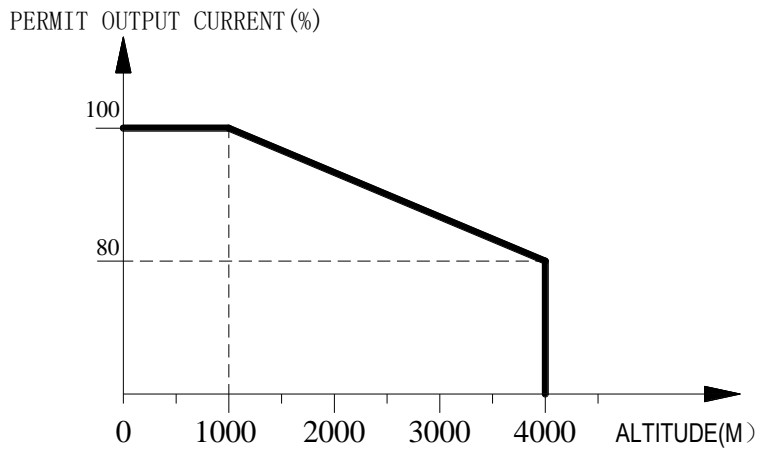

Chart 3-3: RD05 series inverter derating curve while over permit altitude

3.3 Installation Direction and Space

- Installation direction

To prevent inverter cooling effect reducing, please do install the inverter vertically.

- Installation space

Single machine installation: to ensure enough ventilation and wiring space for inverter cooling, please follow installation conditions as follows. The back of the inverter should stick to the wall. So that the surrounding air of radiator can flow freely to ensure the cooling effect.

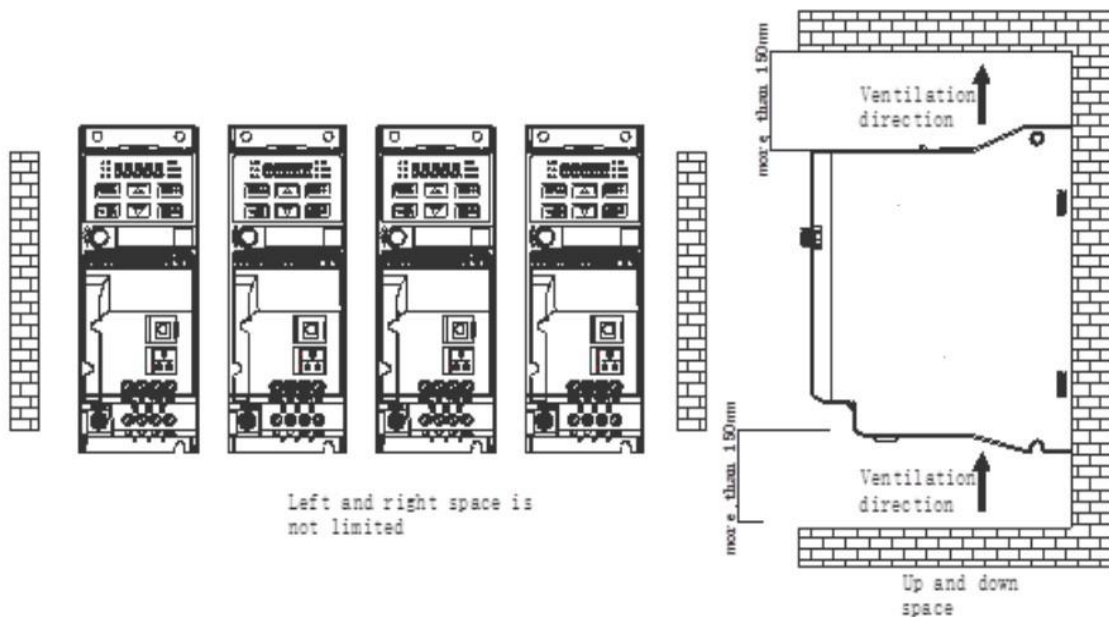
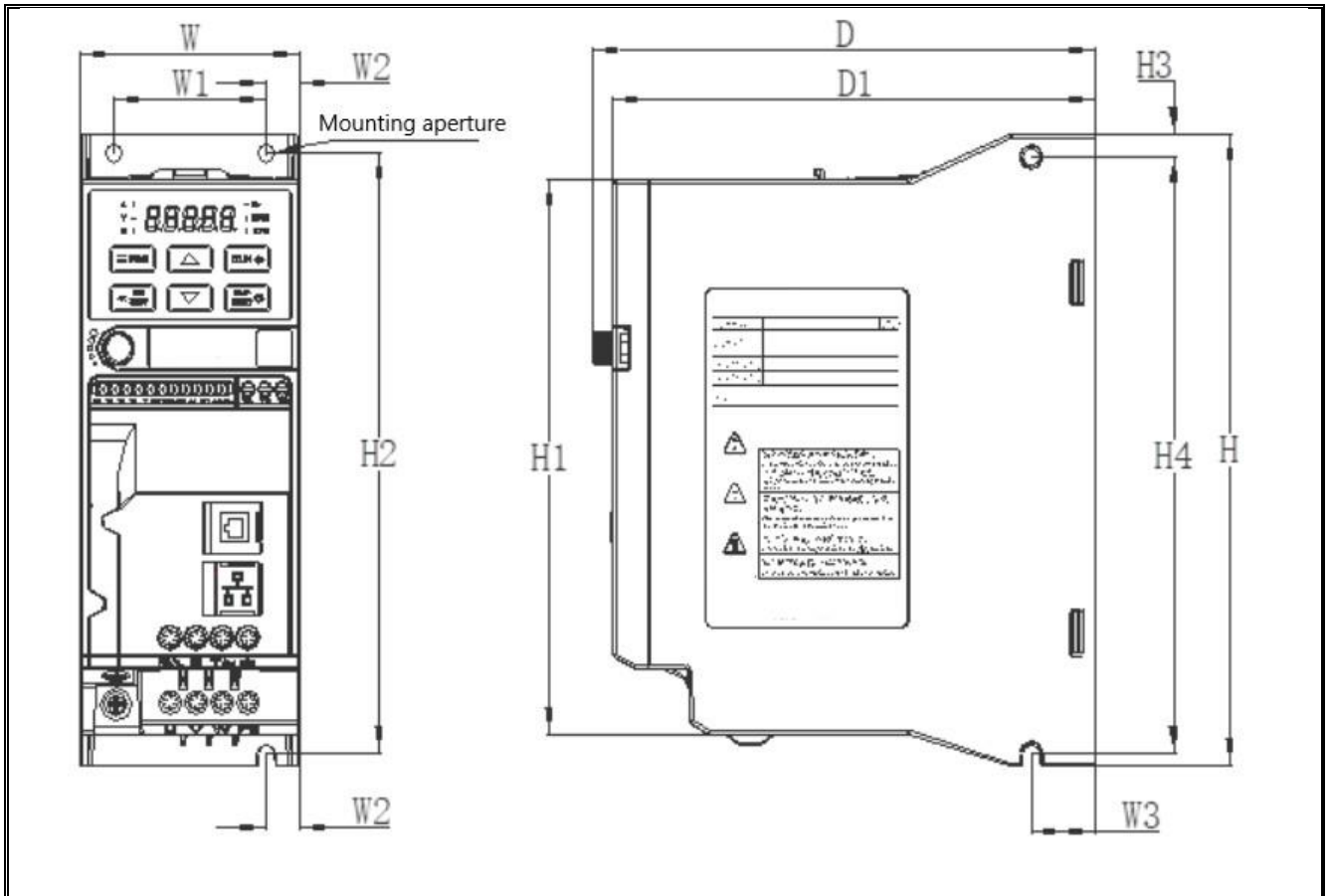

Chart 3-6: Inverters paratactic installation space requirement

3.4 Dimensions

Inverter dimensions



Inverter Model	Dimensions(mm)					Forward mounting size (mm)			Side mounting size (mm)			Mounting aperture
	W	H	H1	D	D1	W1	W2	H2	W3	H3	H4	
RD05-S2-075-IP20-BU	65	177	155	148	142	45	10	168	19	6.5	167	3-M4
RD05-S2-0007-IP20-BU	75	202	180	163	157	55	10	193	19	6.5	192	3-M4
RD05-S2-0010-IP20-BU												
RD05-T4-0003-IP20-BU	65	177	155	148	142	45	10	168	19	6.5	167	3-M4
RD05-T4-0004-IP20-BU												
RD05-T4-0005-IP20-BU												
RD05-T4-0009-IP20-BU	75	202	180	163	157	55	10	193	19	6.5	192	3-M4
RD05-T4-0013-IP20-BU												

Keyboard size

Note: The LCD is fully compatible with the LED keyboard dimensions and opening dimensions.

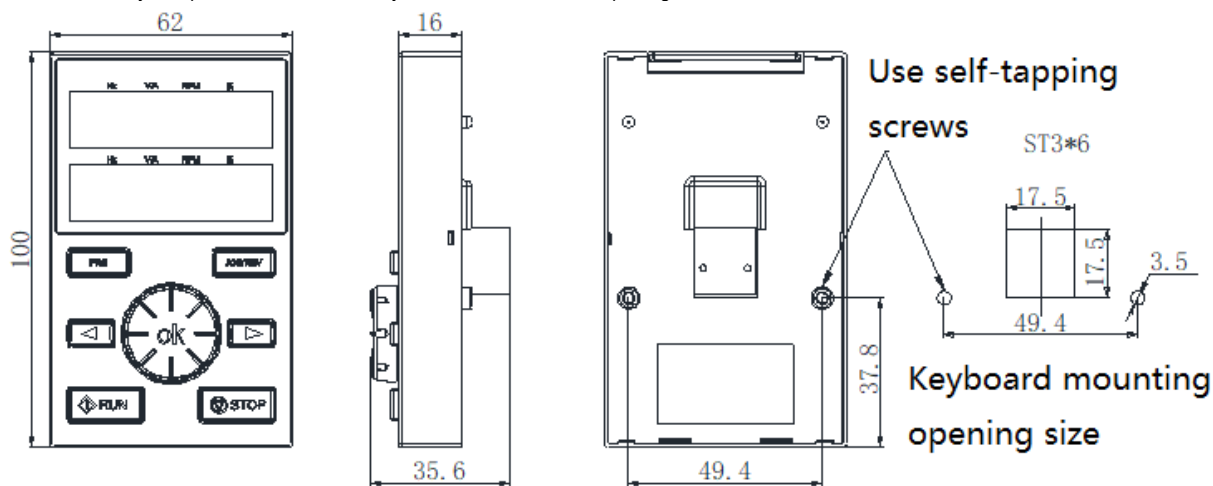

External keyboard shape and opening size chart

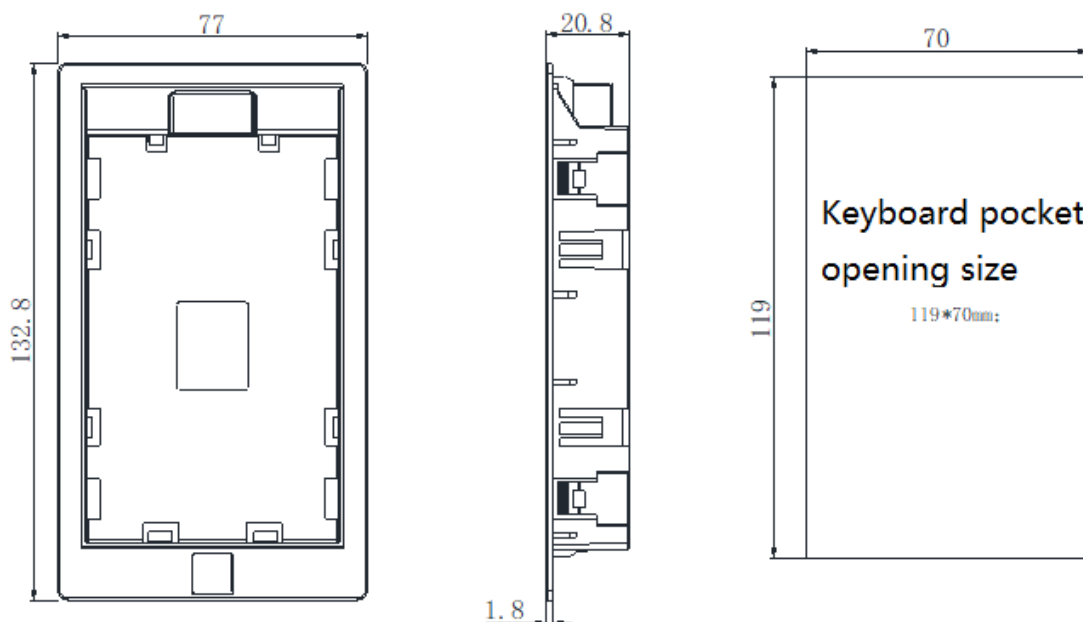

RD11 Keyboard pocket opening size

3.5 Standard Wiring

This chapter explains the regulations that users have to obey to ensure safe use, best performance and reliable running.

Safety precaution

Warn	<ul style="list-style-type: none"> ● Must earth reliably while inverter is running. Otherwise there is danger of casualty and unstable inverter performance. ● To ensure safe running, only trained professional person can do installation and wiring job. ● No operation under power connected state. Otherwise there is danger of electric shock even death. ● Before operation, please cut all related equipment power, ensure that the main circuit DC current has dropped to safe range. And please operate after 5 mins.
Caution	<ul style="list-style-type: none"> ● Control cable, power cable and motor cable must be separated. They can not be in the same cable trough or cable rack. ● This equipment can only be used as the maker states. Please consult VEDA-in DRIVES while using in special case.
Important	<ul style="list-style-type: none"> ● No insulation test for the inverter or the related cable by HV insulation test equipment. ● If the inverter or the peripheral equipment (filter, reactor and etc) needs insulation test, firstly 500V megohmmeter should be used to test the insulation resistance which should not be lower than 4MΩ.

Standard Connection Diagram

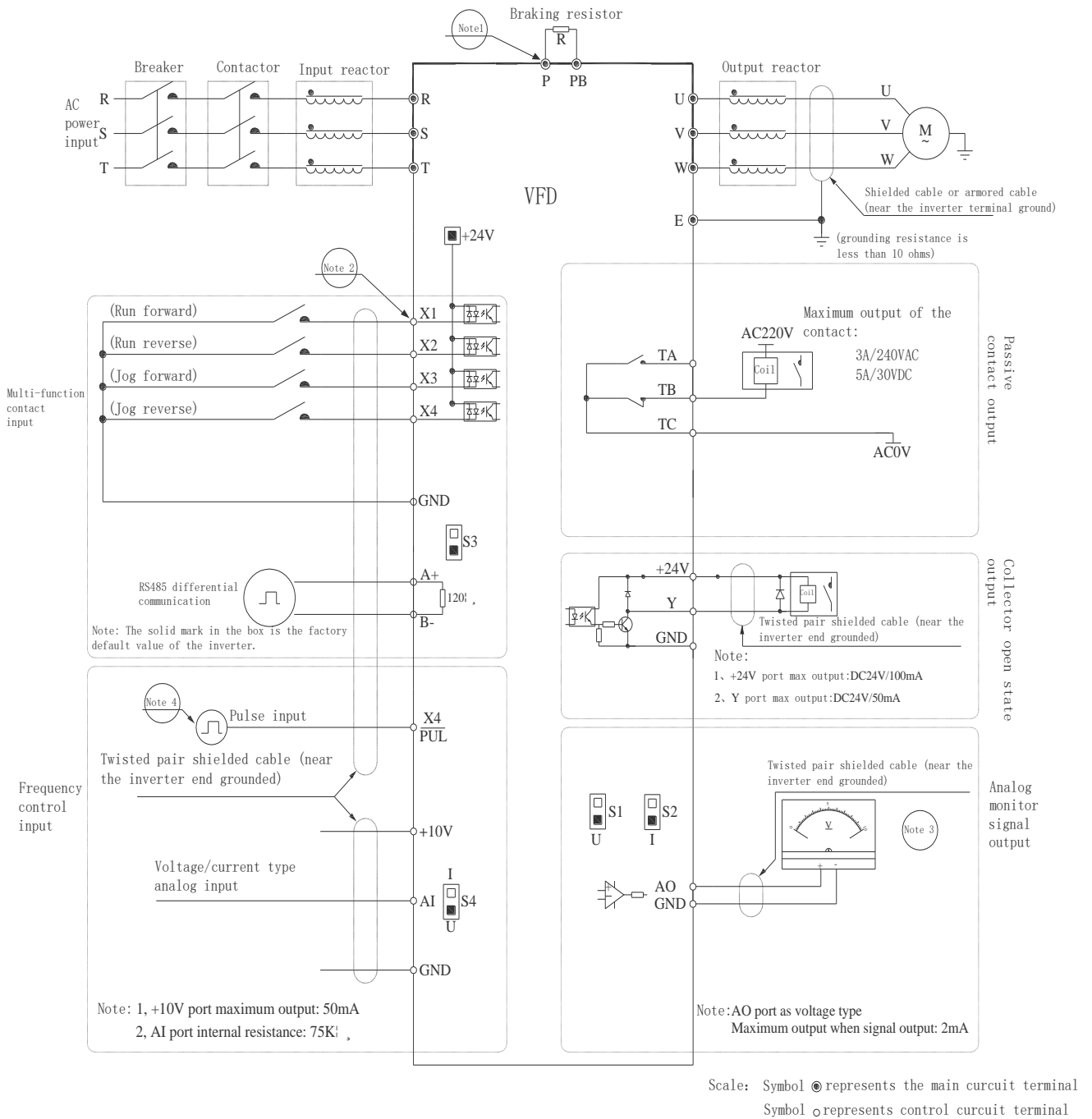

Auxiliary Terminal Output Capability

Terminal	Function definition	Max output
+10V	10V auxiliary power supply output, constitutes loop with GND.	50mA
AO	Analog monitor output, constitutes loop with GND.	As frequency,voltage signal, max output 2mA
+24V	24V auxiliary power supply output, constitutes loop with COM.	100mA
Y	Collector open circuit output, can set the action-object by program.	DC24V/50mA
TA/TB/TC	Passive connector output, can set the action-object by program.	3A/240VAC

Function Specification of Switch Terminals

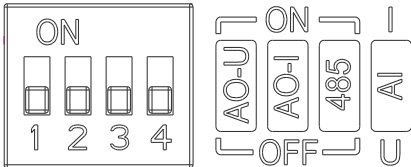

Encode switch	"S" number	Position	Function description
	S1	ON	Enable AO output 0~10V
		OFF	Disabling AO voltage output
	S2	ON	Enable AO output 0~20mA or 4~20mA
		OFF	Disabling AO current output
	S3	ON	RS485 communication access 120Ω termination resistor
		OFF	RS485 communication disconnects 120Ω termination resistor
	S4	I	AI input 0~20mA or 4~20mA
		U	AI input 0~10V

3.6 Main Circuit Wiring

Main circuit terminal arrangement and definition

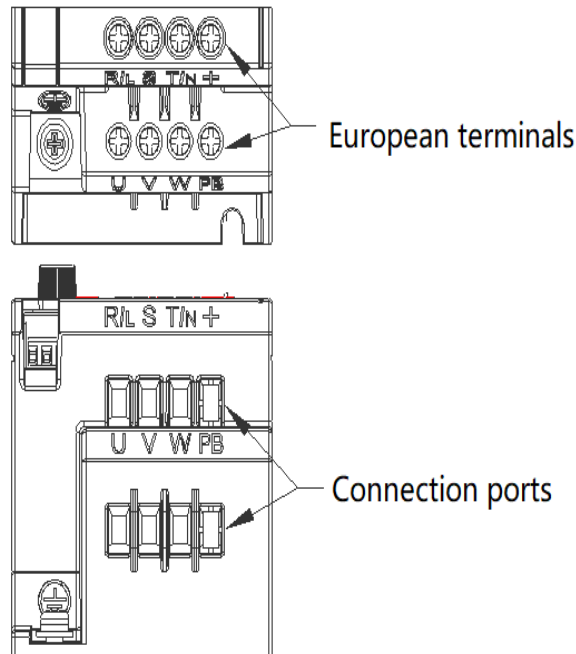

Table 3-3: Main Circuit Terminal Arrangement and Definition of RD05 Series Inverters

Terminal symbol	Terminal name	Terminal function definition
(+)	Brake resistor terminal	For external braking resistors for fast shutdown.
PB		
R	Inverter input terminal	Used to connect three-phase AC power.
S		
T		
U	Inverter output terminal	Used to connect the motor.
V		
W		
⊕	Ground	Ground terminal, grounding resistance <10 ohms.
E		

Wiring of the main circuit of a three-phase 380V class machine

Table 3-4: Recommended main circuit diameter and fixed torque of three-phase 380V class machine

Model	Main circuit terminal screw specifications (mm)	Recommended fixed torque (N·m)	Recommended copper core cable size mm ² (AWG)
RD05-T4-0003-IP20-BU	M4	1.2~1.5	1.5mm ² (14)
RD05-T4-0004-IP20-BU	M4	1.2~1.5	2.5mm ² (12)
RD05-T4-0005-IP20-BU	M4	1.2~1.5	2.5mm ² (12)
RD05-T4-0009-IP20-BU	M4	1.2~1.5	4mm ² (10)
RD05-T4-0013-IP20-BU	M4	1.2~1.5	6mm ² (9)

Wiring of the main circuit of single-phase 220V class machine

Table 3-5: Recommended single-phase 220V class machine main circuit wire diameter and fixed torque

Model	Main circuit terminal screw specifications (mm)	Recommended torque (N·m)	fixed	Recommended copper core cable specifications mm ² (AWG)
RD05-S2-075-IP20-BU	M4	1.2~1.5		2.5mm ² (12)
RD05-S2-0007-IP20-BU	M4	1.2~1.5		2.5mm ² (12)
RD05-S2-0010-IP20-BU	M4	1.2~1.5		4mm ² (10)

Recommended main circuit device specifications

Table 3-6: recommended three-phase 380V class machine main circuit other accessories specifications

Model	Contactor specifications	Circuit breaker specifications	DC reactor	Input filter	Output filter
RD05-T4-0003-IP20-BU	10A	10A	-----	NFI-005	NFO-010
RD05-T4-0004-IP20-BU	10A	10A	-----	NFI-005	NFO-010
RD05-T4-0005-IP20-BU	16A	15A	-----	NFI-010	NFO-010
RD05-T4-0009-IP20-BU	16A	20A	-----	NFI-010	NFO-010
RD05-T4-0013-IP20-BU	25A	20A	-----	NFI-020	NFO-020

3.7 Control Circuit Wiring

Control Circuit Terminal Arrangement

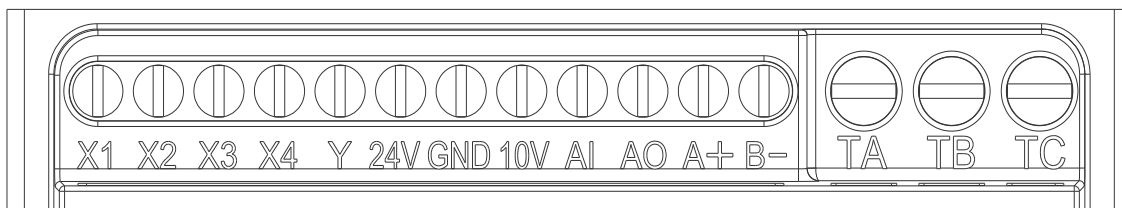

Table 3-7: RD05 series inverter control circuit terminal arrangement and definition

Items	Terminal symbol	Terminal name	Terminal function definition
Analog input	+10V-GND	External +10V power supply	Provide +10V power supply to the outside, the maximum output current: 50 mA is generally used as external potentiometer working power supply, potentiometer resistance range: 1KΩ ~ 5KΩ
	+24V- GND	External +24V power supply	Provides +24V power supply to the outside, generally used as digital input and output terminal working power supply and external sensor power supply Maximum output current: 100 mA
	AI-GND	Voltage or current type analog input	1. Input current range: DC 0V ~ 10V / 0mA ~ 20mA 2. Voltage type input impedance: 100KΩ 3. Current input impedance: 500Ω
Digital input	X1-GND	Multi-function contact input 1	Only unipolar polarity inputs are supported, active low. 1. Input impedance: 6.3 KΩ 2. High-level input voltage range: 10 ~ 30V 3. Low-level input voltage range: 0 ~ 5V
	X2-GND	Multi-function contact input 2	Only unipolar polarity inputs are supported, active low. 1. Input impedance: 6.3 KΩ 2. High-level input voltage range: 10 ~ 30V 3. Low-level input voltage range: 0 ~ 5V
	X3-GND	Multi-function contact input 3	In addition to the features of X1 ~ X3, X4 can also be used as a high-speed pulse input channel (separate model). 1. The highest input frequency: 100KHZ 2. Input impedance: 6.3KΩ 3. Pulse input signal level range: High level: 10~30V; Low level: 0~5V
	X4-GND	Multi-function contact input 4	
	X4/PUL-GND	Multi-function contact input 4 / high speed pulse input	
Analog output	AO-GND	Analog output	1. Output voltage range: DC 0V ~ 10V 2. Output current range: DC 0mA ~ 20mA
Digital output	Y-GND	Digital output	Open collector output 1. Output voltage range: DC 0V ~ 30V 2. Output current range: DC 0mA ~ 50mA
Relay output	TA-TC	Normally open terminal	Contact drive capability: 240VAC, 3A
	TB-TC	Normally closed terminal	30VDC, 5A

Communication terminal	A+	Communication terminal A+	RS485 communication interface. Selecting the RS485 communication access 120 Euro termination resistor by the toggle switch S3
	B-	Communication terminal B-	

Control Circuit Terminal Wiring Specifications

Terminal name	Screw specification (mm)	Fixed torque (N·m)	Cable specification (mm ²)	Cable type
A+ B-	M2.5	0.4~0.6	0.75	Twisted pair shielded cable
+10V GND AO AI	M2.5	0.4~0.6	0.75	Twisted pair shielded cable
+24V GND Y TA TB TC X1 X2 X3 X4	M2.5	0.4~0.6	0.75	Shielded cable

3.8 Set the Braking Resistor

Machine braking resistor connection

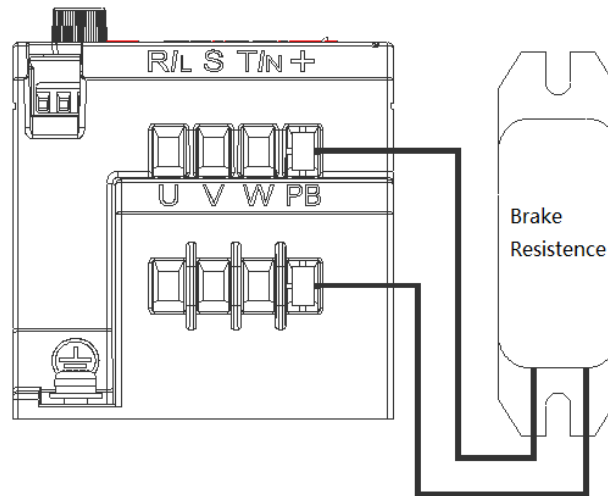

Figure 3-9: Connection diagram of the braking resistor of the RD05 series inverter

Suggested braking resistance specification parameters

Braking resistance value and power in the chart are decided according to common inertia load and intermittent braking mode. While used in large inertia occasion or long time frequent brake occasion, please adjust resistance value and power according to the inverter specification and the rated parameter of braking unit. If any problem, please consult customer service department of VEDA-in DRIVES.

Three-phase 380V rating			
Motor power (kW)	Resistance value (Ω)	Resistance power (W or kW)	Braking torque (%)
0.75 kW	750 Ω	150W	100%
1.5 kW	400 Ω	300W	100%
2.2 kW	250 Ω	400W	100%
4.0 kW	150 Ω	500W	100%
5.5 Kw	100 Ω	600W	100%
Single phase 220V rating			
Motor power (kW)	Resistance value (Ω)	Resistance power (W or kW)	Braking torque (%)
0.75 kW	200Ω	120W	100%
1.5 kW	100Ω	300W	100%
2.2 kW	75.0Ω	300W	100%

Build-in braking unit max braking performance

Braking unit of RD05 series product with low power can be selected according to the suggested braking resistance specification parameters in table above. In large inertia or long time frequent brake occasion, the moment maybe should be increased. The max braking power is showed in the following table, the range of which can not be over in use. Otherwise the equipment maybe destroyed. If any problem, please consult VEDA-in DRIVES customer service department.

RD05 series inverter built-in brake unit maximum brake output

Three-phase 380V rating			
Inverter model	Motor power	Maximum braking current	Minimum resistance
RD05-T4-0003-IP20-BU	0.75 kW	3.5A	200Ω
RD05-T4-0004-IP20-BU	1.50 kW	3.5A	200Ω
RD05-T4-0005-IP20-BU	2.2 kW	7.0A	100Ω
RD05-T4-0009-IP20-BU	4.0 kW	10A	75Ω
RD05-T4-0013-IP20-BU	5.5 kW	10A	75Ω
Single phase 220V rating			
Inverter model	Motor power	Maximum braking current	Minimum resistance
RD05-S2-075-IP20-BU	0.75 kW	3.8A	100Ω
RD05-S2-0007-IP20-BU	1.50 kW	6.5A	60Ω
RD05-S2-0010-IP20-BU	2.2 kW	10.5A	40Ω

3.9 Standby Control System

Frequency inverter is composed of semiconductor, passive electronic component and driving part. All of them have useful time, which means these parts may happen characteristic change or out of use in normal working environment. And it will cause product fault. To avoid production stop led by the fault, we suggest preparing standby control system when using the inverter.

Chart 3-11 is a standby control system for manual switch to power supply driving motor at inverter fault. Standby control systems such as power supply Y/Δ step-down start way driving motor, power supply self-coupling reduction voltage start mode driving motor, power supply soft start mode driving motor or standby inverter system can be chose to use according the actual requirement and environment.

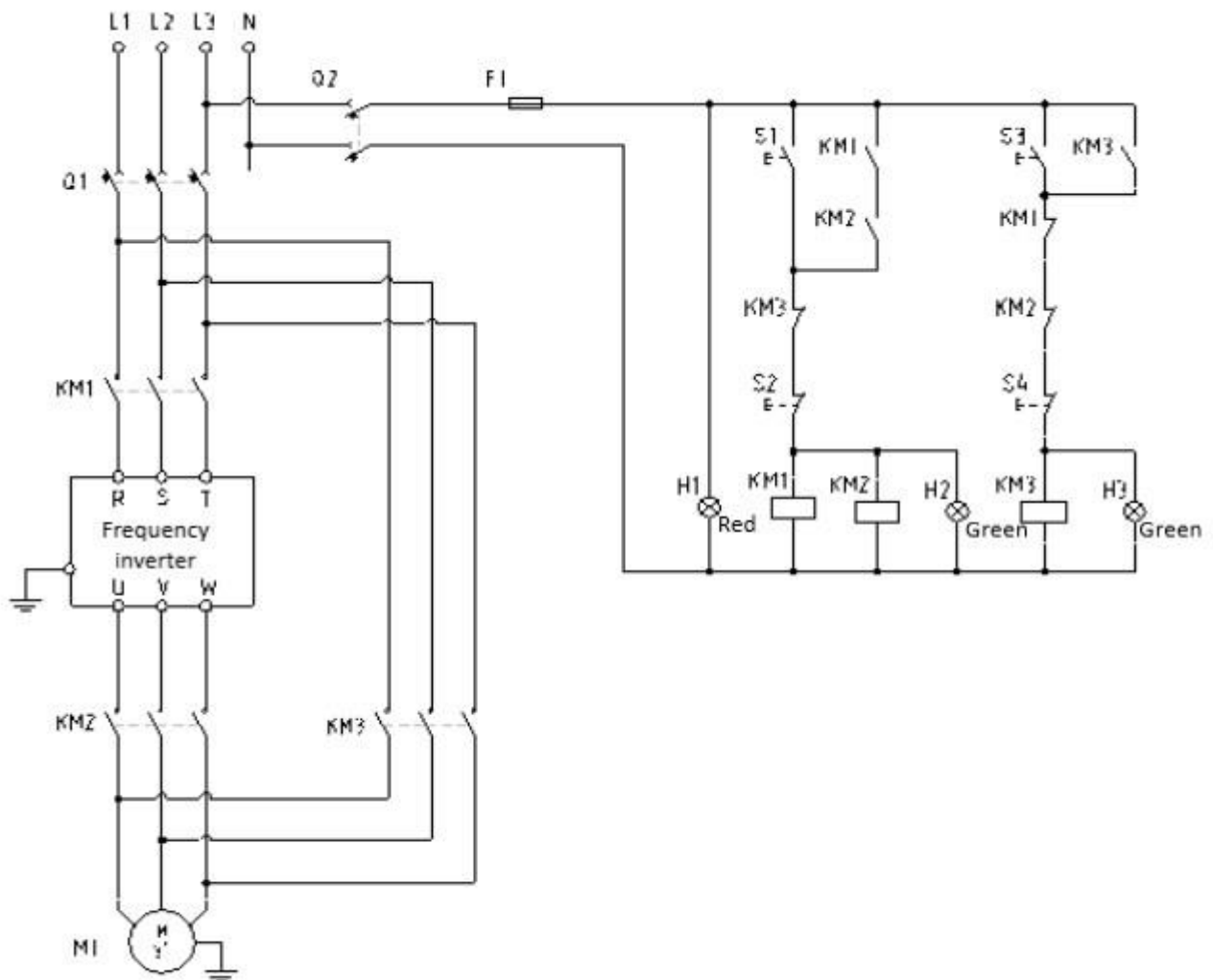

Chart 3-11: Standby control system of power supply directly driving model

4 Basic Operation and Trial Run

4.1 Safety Precautions

DANGER

Please pay attention to all the information about safety in this book.

If you do not follow the warnings, you may cause death or serious injury, so please pay attention. The company will not be responsible for any damage or equipment damage caused by your company or your company's customers who fail to comply with the contents of this book.

4.2 Keyboard Layout and Functions Specification





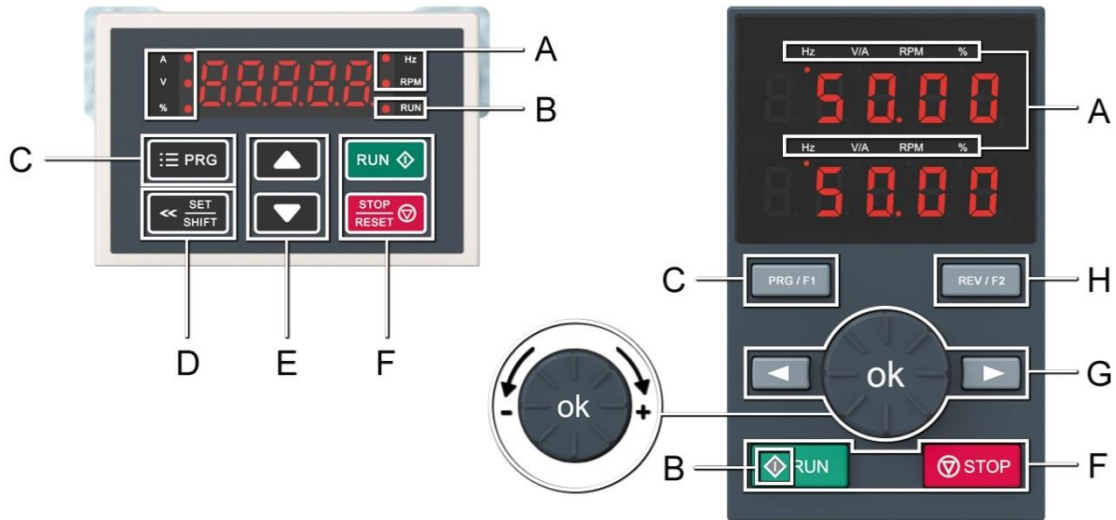

●Keyboard name





Integrated keyboard (37KW and below)

Double-line keyboard (37KW or more FC)

















●Key function



Symbol	Integrated keyboard	Double-line keyboard	Function
A	Unit indicator		Hz: Frequency A: Current V: Voltage V/A: Voltage or current RPM: Speed %: Percentage
B	Status Indicator		On: Forward running status Blinking: Reverse running status Off: Stop status
C	Menu 	Menu 	Enter the function menu interface during standby or running; press this button to exit the modification when the parameter is modified; press the button (1 second) during standby or running to enter the status interface directly.
D	Set/Shift 		Set function: After modifying the value, press this key to confirm the modified value. Shift function: long press this button (1 second) to move the operation bit, long press is not loose, then cyclic shift
E	Up, Down 		The up key increases the operation value and the down key decreases the operation value.
F	Run 	Run 	When the run/stop is controlled by the keyboard, press this button to turn the inverter forward. The status indicator is always on during forward run, and the status indicator is flashing during reverse run.









	<p>Stop/Reset</p> 	<p>Stop/Reset</p> 	<p>When the command given channel is keyboard control, press this key to stop the inverter; the parameter [F04.08] can be used to define whether other command channels are valid; the inverter resets when pressing the key in fault status.</p>
G			<p>Digital potentiometer: clockwise to increase the operating value, counterclockwise to decrease the operating value</p>
		<p>Set key: After modifying the value, press this key to confirm the modified value.</p>	
		<p>Left/Right shift</p> 	<p>Move left and right operation bits</p>
H		<p>Jog/Reverse</p> 	<p>Select the function of the key by parameter [F04.07], 0: reverse 1: jog</p>

● Number word comparison table

Word	LED Display	Word	LED Display	Word	LED Display
0		C		O	
1		D		P	
2		E		Q	
3		F		R	
4		G		S	
5		H		T	
6		I		U	
7		J		V	
8		K		W	
9		L		X	No Display
A		M		Y	
B		N		Z	No Display

4.3 LED Status Indicator

In the following chart:  represents light on,  represents light off,  represents flashing.

RUN Running lights	RUN 	Light off: stop status
	RUN 	Lights on: running forward
	RUN 	Blinking: Reverse running
Run  Button	RUN 	Light off: stop state
	RUN 	Lights on: running forward
	RUN 	Blinking: Reverse running
Unit indicator Hz、A、V、RPM、%		Light on: Monitor this value
		Light off: no value is monitored
Hz: frequency A: current V: voltage RPM: speed %: percentage		

4.4 Initial Startup Step

The following is the basic initial startup procedure of our inverter. For the first time, please refer to the corresponding flow chart according to the actual situation for use; here only the most basic settings are introduced, and the user can operate according to this step;

Flow chart 1

Flowchart 1 is the pilot test guide for the inverter. When the inverter is first run and debugged, the customer can operate according to the flow to debug the inverter.

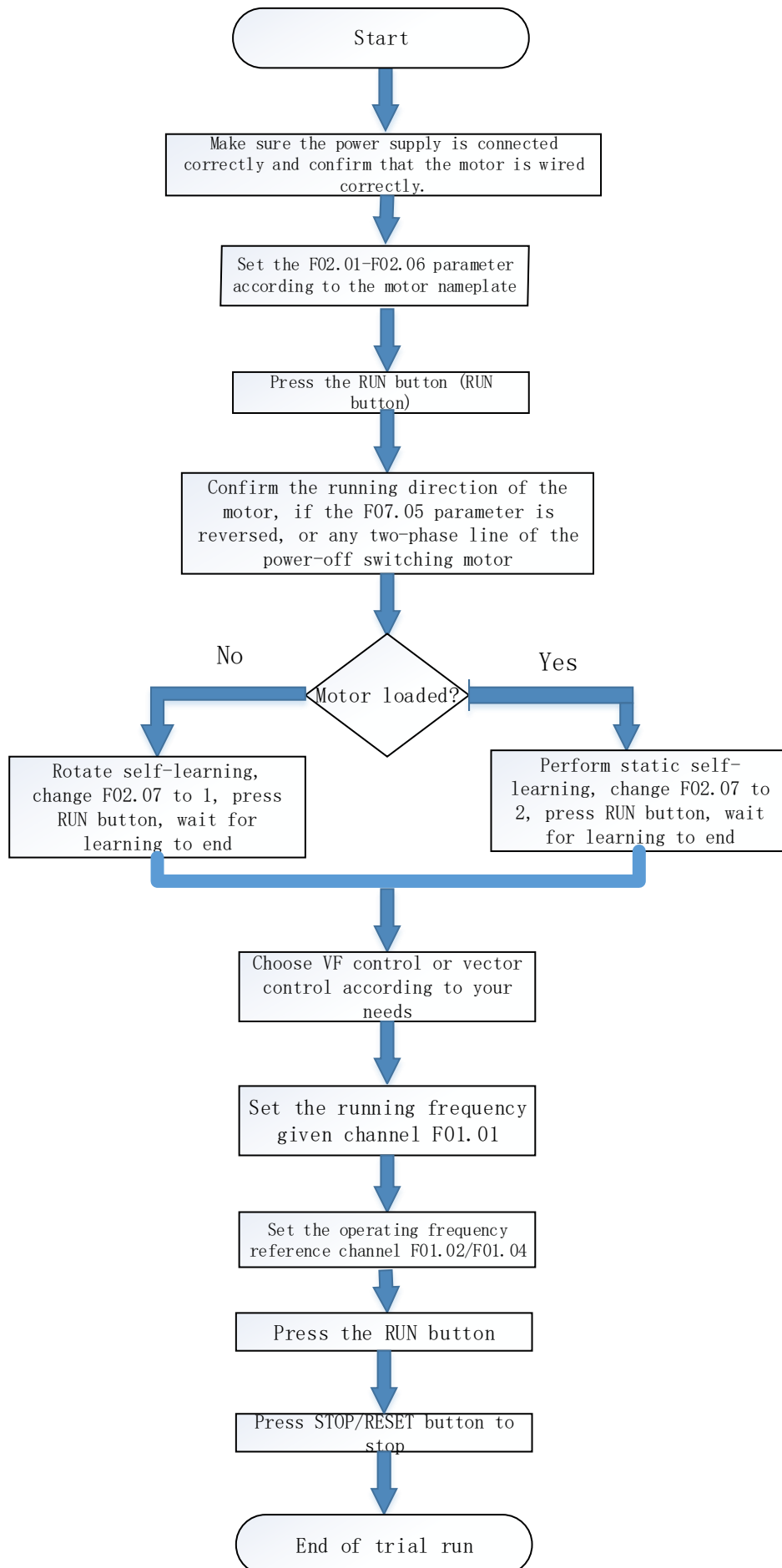

Flow chart 2

Flow chart 2-bit motor parameter self-tuning process, the effect of controlling the motor for the inverter is better, and the motor parameter self-tuning is required; (Note: be sure to set the motor rated parameters before learning.)

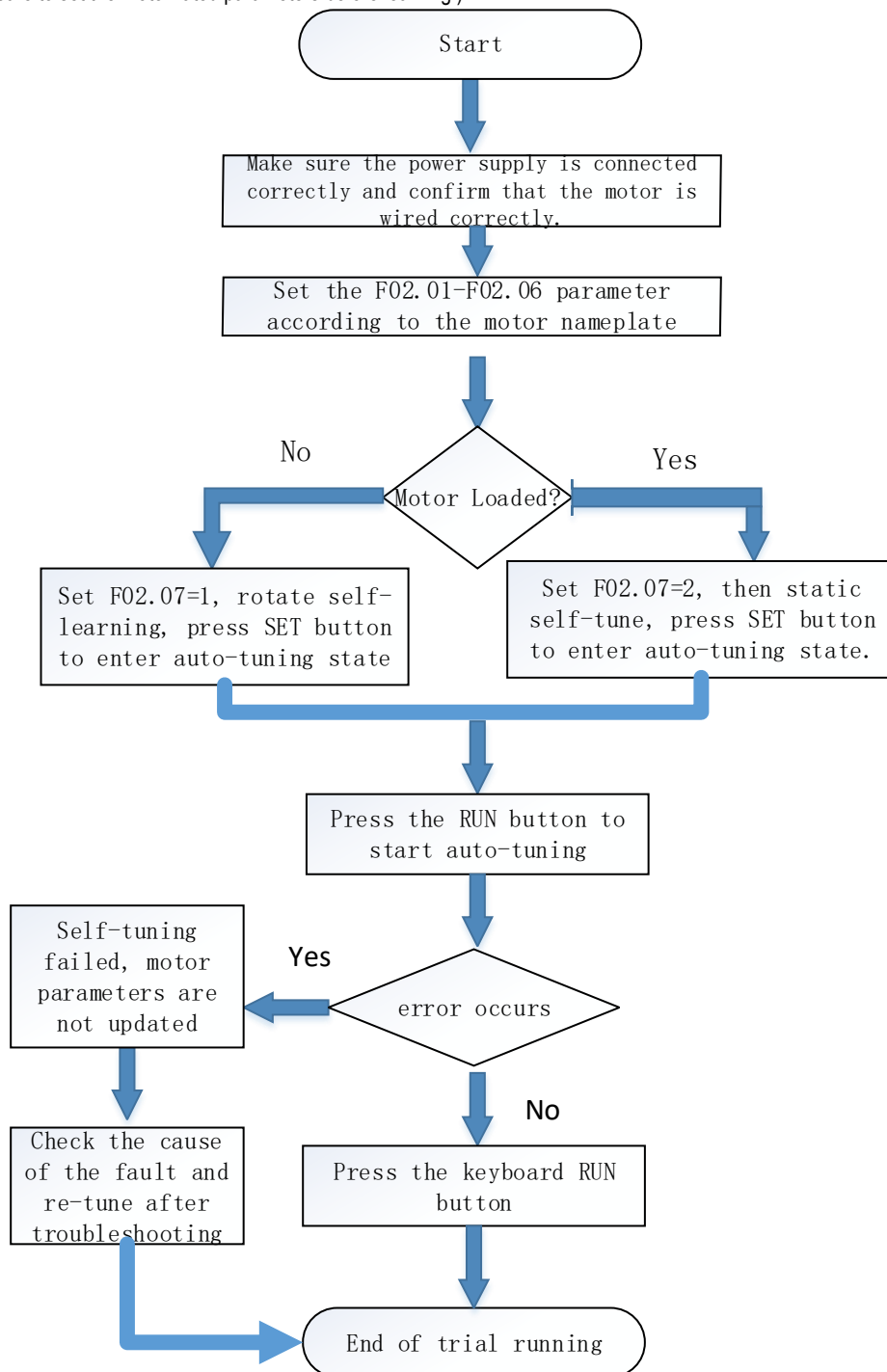

Flow chart 3

The flow chart 3-bit vector control flow, according to the process debugging vector mode, makes the inverter control performance better;

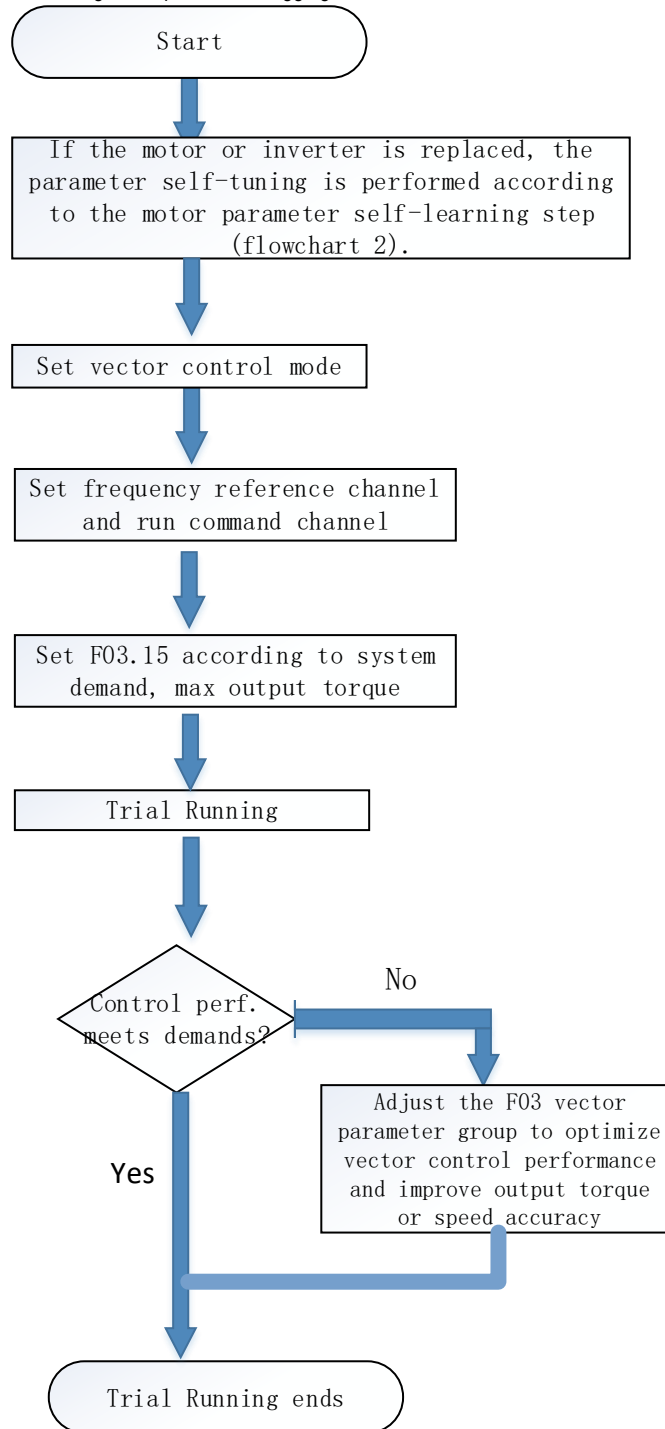

4.5 Confirmation at the Time of Initial Startup

Confirmation before turning on the power

Before turning on the power, be sure to confirm the following items to ensure the safety of the person and the inverter.

Confirmation	Related Information
Input power supply voltage specification	Confirm that the input power supply voltage specification is correct Single phase 220V 50/60Hz Three-phase 220V 50/60Hz Three-phase 380V 50/60Hz
	Ensure that the power supply does not fluctuate significantly
	Confirm that the inverter and motor are properly grounded
Connection of inverter output terminal and motor terminal	Make sure that the wiring of the inverter output terminals (U, V, W) and the motor terminals are reasonable and correct.
Control circuit terminal wiring	Confirm that the control circuit terminal wiring of the inverter is reasonable and correct.

Control circuit terminal status	Confirm that the signals input from the switch type connected to the control circuit terminal of the inverter are disconnected.
Motor and mechanical connection status	Confirm that the motor and mechanical connections are correct and reasonable

Confirmation after turning on the power

After power-on, you should check whether the inverter shows fault. If the power is on, it can be operated according to reasonable steps. If the fault occurs according to the fault code, the relevant operations can be performed after the fault is solved.

Make initial settings

4.6 Keyboard Operation Method

Basic parameter group parameter setting

The following is an example of setting the F1.22 [acceleration time] = 10.00s to illustrate the basic operation of the LED operator.

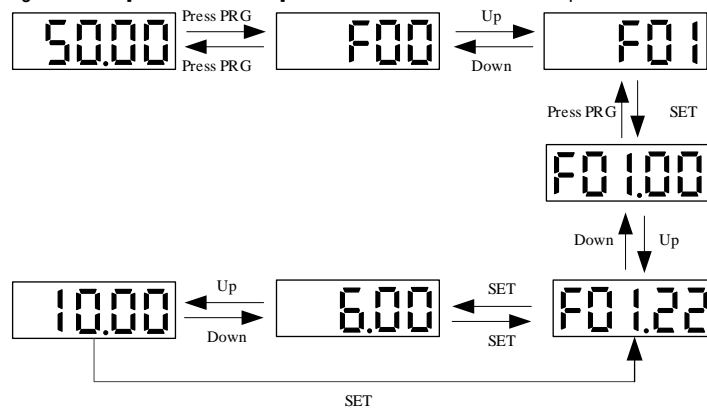

Note: When modifying the ten, hundred and thousand digits of the parameter value, use the keyboard shift key function to quickly select.

Run monitoring status view

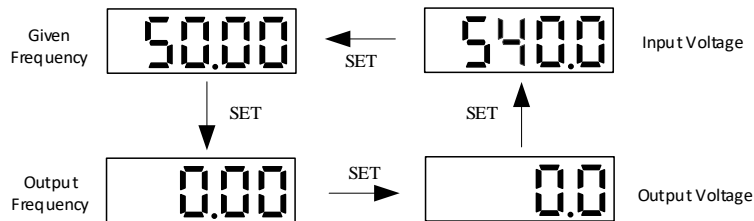

Note: When using the external keyboard, use the left shift button to cycle through the first line of monitoring parameters, and use the right shift button to cycle through the second line of monitoring parameters.

Monitoring parameter view

Let's take a look at C02.05 [PLC Operation Phase] as an example to illustrate the basic operation of the LED operator.

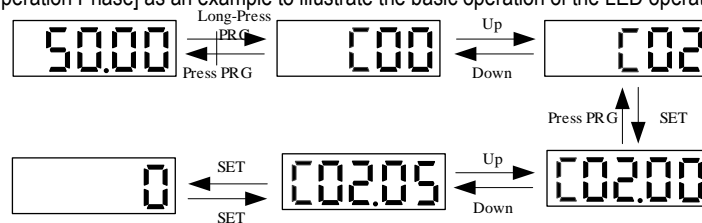

4.7 Self-tuning

Note: The S2/T2 model does not support motor parameter self-tuning.

Self-tuning is an automatic measurement of the motor characteristic value required for vector control and automatically sets this value to the function of the inverter. The methods for obtaining the internal electrical parameters of the controlled motor are: dynamic self-tuning, static self-tuning, stator resistance self-tuning, manual input motor parameters, etc. Select the most suitable self-tuning mode according to the type of motor used, the control mode of the inverter, and the installation environment of the motor. Enter the necessary parameters according to the selected self-tuning mode and the control mode set by F01.00.

WARNING! For mechanical safety: When implementing rotary self-tuning, the motor will rotate at a speed of 50% or more of the rated frequency. Please confirm the safety around you. Failure to do so may result in personal injury or mechanical damage.

Asynchronous motor self-tuning

The following describes the motor parameter self-tuning method for asynchronous motors. The following parameters must be set for self-tuning.

Motor parameters is F02.01~F02.06.

(Note) Stop-type self-tuning is an alternative function when rotary self-tuning cannot be implemented. Therefore, sometimes the measurement result of the self-tuning becomes larger than the error of the motor characteristic. After the stop type self-tuning is completed, confirm the measured motor characteristic value by parameter.

Asynchronous motor self-tuning

Self-tuning mode parameter setting	Applicable conditions and advantages	Control mode that can be applied (set value of F01.00)	
		V/F (0)	SVC (1)
Dynamic rotation self-tuning F02.07=1	<ul style="list-style-type: none"> The motor can be disconnected from the mechanical load, and the motor can rotate without any problem during self-tuning. When running a constant output characteristic motor. In order to obtain the highest precision motor control when high-precision control is required, perform rotary self-tuning as much as possible. The motor cannot be removed from the mechanical load when the load on the motor is less than 30%. 	○	○
Static self-tuning F02.07=2	<ul style="list-style-type: none"> The motor cannot be removed from the mechanical load and the load on the motor exceeds 30%. When the test report of the motor or the data indicated on the motor nameplate cannot be obtained, the stop type self-tuning energizes the motor for about 1 minute while the motor is stopped, and automatically measures the necessary motor data. Self-tuning can automatically calculate and set the motor parameters required for vector control when driving a motor with light load. 	○	○
Stator resistance self-tuning F02.07=3	<ul style="list-style-type: none"> Self-tuning has been implemented, but after the motor is installed, the wiring distance between the inverter and the motor becomes 50 m or more. When the wiring distance under V/f control is above 50m When the motor output and inverter capacity are different 	○	○

Asynchronous motor self-tuning input data

When implementing self-tuning, please enter the items in the table below that have ○. Before implementing self-tuning, please confirm the test report of the motor or the data indicated on the motor nameplate.

Asynchronous motor self-tuning input data

Input data	Parameter	Unit	Self-tuning mode (set value of F02.07)		
			Rotary self-tuning (0)	Static self-tuning (1)	Stator resistance self-tuning (2)
Number of motor poles	F02.01	-	○	○	-
Motor rated power	F02.02	Kw	○	○	○
Motor rated frequency	F02.03	Hz	○	○	
Motor rated speed	F02.04	Rpm	○	○	-
Motor rated voltage	F02.05	V	○	○	○
Motor rated current	F02.06	A	○	○	○

4.8 Trial Run

Set the basic parameters and start the trial run after the motor self-tuning.

WARNING! For mechanical safety: After wiring work and parameter setting are completed, be sure to perform a trial run to confirm that the machine can operate safely. Doing so may result in injury or equipment damage.

4.8.1 Trial run under no-load condition

Before connecting the motor to the machine, please confirm the running status of the motor.

Pre-operational notes

Please confirm the following items before running the motor.

- Check the safety around the motor and machine.
- Check that the emergency stop circuit and the mechanical side safety device are operating correctly.

Confirmation at runtime

Please confirm the following items during operation.

- Whether the motor is running forward.
- Whether the motor rotates smoothly (whether there is abnormal sound and vibration).
- Whether the motor accelerates and decelerates smoothly.

4.8.2 Empty load trial run

The empty trial run procedure is described below.

- Turn on the power to power on the inverter and the keyboard is displayed normally.
- Press the keyboard PRG key to set the keyboard digital reference frequency parameter F01.09, and set the frequency to 5.00Hz.
- Press the RUN key, the running indicator lights up, and the motor rotates forward at 5.00 Hz.
- Confirm that the motor rotates in the correct direction and the inverter has no fault display; if the fault is displayed, the cause of the fault is eliminated.
- Increase the given frequency of the inverter, change the value of F01.09 by the up/down keys, confirm the responsiveness of the motor, and adjust F01.09 with the amplitude of 10Hz.
- Each time the set value is increased, the output current of the inverter should be confirmed by C00.02 (output current). If the output current of the inverter

does not exceed the rated current of the motor, it is normal.

Example: 5 Hz → 10 Hz → 20 Hz → 30 Hz → 40 Hz → 50 Hz

7. After confirming that the motor can rotate normally, press the STOP button, the running indicator will go out after the motor is completely stopped.

Actual load trial run

After confirming the operation in the no-load state, connect the motor to the mechanical system for trial operation.

Pre-operational notes

- Check the safety around the motor and machine.
- Make sure the motor is completely stopped.
- Please connect the motor and machine. Check if the mounting screws are loose and secure the motor shaft and mechanical system.
- To prevent abnormal movements in case, please be prepared to press the STOP button of the operator at any time.

Confirmation at runtime

- Is the machine moving in the correct direction (whether the direction of rotation of the motor is correct).
- Whether the motor accelerates and decelerates smoothly.

4.8.3 Trial Running with Load

After connecting the machine to the motor, perform the trial run in the same procedure as the no-load trial run.

- Check if C00.02 (output current) is too large.

1. Turn on the power to power on the inverter and the keyboard is displayed normally.

2. Press the keyboard PRG key to set the keyboard digital reference frequency parameter F01.09, and set the frequency to 5.00Hz.

3. Press the RUN key, the running indicator lights up, and the motor rotates forward at 5.00 Hz.

4. Confirm that the motor rotates in the correct direction and the inverter has no fault display; if the fault is displayed, the cause of the fault is eliminated.

5. Increase the given frequency of the inverter, change the value of F01.09 by the up/down keys, confirm the responsiveness of the motor, and adjust F01.09 with the amplitude of 10Hz.

6. Each time the set value is increased, the output current of the inverter must be confirmed by C00.02 (output current). It is normal if the output current of the inverter does not exceed the rated current of the motor.

Example: 5 Hz → 10 Hz → 20 Hz → 30 Hz → 40 Hz → 50 Hz

7. After confirming that the motor can rotate normally, press the STOP button, the running indicator will go out after the motor is completely stopped.

8. Change the frequency command and direction of rotation to confirm if there is abnormal sound and vibration.

9. If there is a control fault such as an offset or vibration, please make adjustments.

4.9 Precision Adjustment during Trial Running (Control Performance Optimization)

The following describes how to adjust the control faults such as offset or vibration that occur during the trial run. Adjust the corresponding parameters in the table according to the control mode used and the status of the inverter.

Note: Only the parameters with higher adjustment frequency are listed in this section. When you need more precise inverter adjustment, please contact us.

V/f control mode

Parameters used for fine tuning of the inverter (V/f control mode)

Malfunction	Parameter number	Countermeasures	Factory setting	Recommended value
1. The motor has large electromagnetic noise. 2. When the speed is low (10 Hz or less) or medium speed (10 to 40 Hz), misalignment and vibration occur.	F01.40 [carrier frequency]	<ul style="list-style-type: none"> · Increase the carrier frequency when the motor electromagnetic noise is high. · When there is an offset or vibration at low speed or medium speed, lower the carrier frequency. 	Model determination	1.0~ upper limit
1. The torque is insufficient at low speed (below 10 Hz). 2. Disorder, vibration	F04.01 [Torque boost]	<ul style="list-style-type: none"> · When the torque is low at low speed, increase the set value. · If the offset or vibration occurs at light load, lower the set value. 	Random setting	0.0~ upper limit
Poor speed accuracy	F04.03 [slip compensation gain]	<ul style="list-style-type: none"> · After setting F2.06 [Motor rated current], F2.04 [Motor rated speed], F2.10 [Motor no-load current], adjust F04.03 as appropriate. 	0.0%	50.0%~150.0%

PG-free vector control mode

Parameters used for fine tuning of the inverter (no PG vector control mode)

Malfunction	Parameter number	Countermeasures	Factory setting	Recommended value
1. Torque and speed response are slow. 2. occurs at medium speed (10 ~ 40Hz) Offset, vibration	F03.02 [Speed loop proportional gain 1] F03.06 [Speed loop proportional gain 2]	<ul style="list-style-type: none"> · When it is necessary to improve the responsiveness of torque and speed, gradually decrease the set value by 0.05. · When an imbalance or vibration occurs, gradually increase the set value by 0.05. 	10.00	0.01~100.00
	F03.03[Speed loop integration time 1] F03.07[Speed loop integration	<ul style="list-style-type: none"> · When it is necessary to improve the responsiveness of torque and speed, gradually confirm the responsiveness and gradually 	0.100	0.000~6.000 s

	time 2]	decrease the set value by 0.01. · When an offset, vibration, or load moment of inertia occurs, confirm the responsiveness and gradually increase the set value by 0.05.		
An overvoltage fault occurs at the end of acceleration, at the start of deceleration, and when the load changes abruptly.	F03.04 [Speed loop filter time 1] F03.08 [speed loop filter time 2]	· When overvoltage occurs, confirm the responsiveness and gradually increase the set value by 4ms. · When the response is slow, the responsiveness is confirmed, and the set value is gradually lowered by 2 ms.	0.00s	
The speed accuracy is poor	F03.23[Asynchronous machine slip compensation gain]	· When the speed is slow, gradually increase the set value by 10%. · When the speed is fast, gradually lower the set value by 10%.	100%	0~250%
1. The motor has large electromagnetic noise. 2. Misalignment and vibration occur at low speed (below 10 Hz)	F01.40 [carrier frequency selection]	· Increase the carrier frequency when the motor electromagnetic noise is high. · If there is an offset or vibration at low speed or medium speed, lower the carrier frequency.	1.0kHz	1.0~upper limit

After checking the above items, please check the following items:

Check	NO.	Content
	16	Does the keyboard and keyboard display normally when I start running?
	17	When entering the run command and frequency command from the keyboard, do you press F01.01=0 (keyboard control), F01.02=0?
	18	When the motor rotates in the wrong direction during the trial run, have you tried to exchange any two of the inverter output terminals U, V, W?
	19	Is F02.06 (rated motor current) and F10.30 (motor overload protection curve factor) set correctly to ensure correct operation of motor overload protection?
	20	When the operation command and frequency command are input from the control circuit terminal, has F01.01=0, F01.02=0?
	21	When inputting a frequency command from the analog input terminal AI · Voltage input - Is it confirmed that the external switch of the inverter places the AI on the U side? - Is F01.02 = 2 [terminal AI1 function selection = main speed frequency command] set? · Current input - Is the internal switch of the inverter confirmed to place the AI at the I terminal? - Is F01.02 = 2 [terminal AI1 function selection = main speed frequency command] set?
	22	Did you confirm that the frequency command reached the required minimum/maximum value? → When the desired value is not reached, check the following items. Gain adjustment: Set the maximum voltage/current value and adjust the analog input gain before the frequency command reaches the desired value. (Frequency reference channel A gain F01.03; frequency reference channel B gain F01.05) Offset adjustment: Set the maximum voltage/current value and adjust the analog input offset until the frequency command reaches the desired minimum value. (When terminal AI1 is input: F05.50~F05.53, when terminal AI2 is input: F05.55~F05.58)

5 Network Communication

5.1 Safety Precautions

Please pay attention to all the information about safety in this book.

Failure to follow the warning may result in death or serious injury. The company will not be held liable for any damage or equipment damage caused by your company or your company's customers who fail to comply with the warnings in this book.

5.2 MODBUS Communication

NOTES

Parameter [F11.30] sets the MODBUS/external keyboard to choose one. This parameter is not restored with the [F00.03] parameter. Users are strongly advised to unlock the hardware connection of another channel when using one of them.

The RD05 series inverters are equipped with RS485 communication interface and the master-slave communication using the international standard Modbus communication protocol. The user can realize centralized control through PC / PLC, host computer, main station inverter, etc. (set inverter control command, running frequency, modification of related function code parameters, inverter working status and fault information monitoring, etc.) to adapt Specific application requirements.

5.2.1 Host/Slave Configuration

The communication between the master and the slave (serial communication) is usually performed by the host starting communication and the slave responding. The host pre-sets the address number for each slave and specifies the number for signal communication. The slave that receives the host instruction performs the function specified by the host and responds to the host.

5.2.2 Communication rules

The MODBUS communication format is shown in the table below:

Project	Description
Interface	RS-485 (RS232 interface requires an additional RS232/RS485 converter)
Synchronous method	asynchronous
Communication frame	Baud rate: 1200, 2400, 4800, 9600, 19200, 38400, 57600, bps
	Data length: 8 bits (fixed)
	Check: odd, even, no
	Stop bit: 1 bit (fixed)
Protocol	Modbus protocol (RTU only (mode))

Note: The RD05 series only supports RTU mode.

5.2.3 Information format

In RTU mode, a new frame begins with a transmission time pause interval of at least 3.5 bytes. The data fields transmitted next are: slave address, operation command code, data and check word, the transmission of the last byte is completed, and the end of the frame is indicated by a transmission time interval of at least 3.5 bytes. . The RTU data frame format is shown in the figure below.

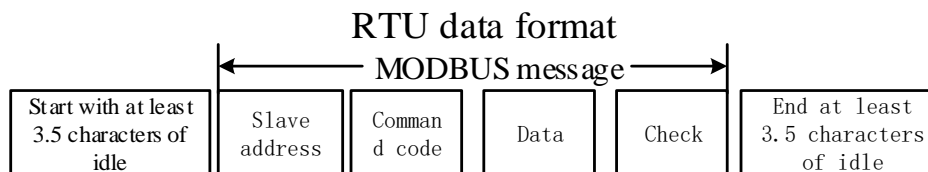

Slave address

Please set a value from 0 to 247 (decimal). When the slave address is set to 0, the master is broadcast, and all slaves receive the command. For broadcast transmission, the slave does not send a response message to the primary station.

Command code

Command code	Features
03H	Read slave parameters
06H	Read slave parameters
08H	Loop self-test

Data

The data of the parameter code of the inverter and the data corresponding to the parameter code are combined into a series of data, including reading the parameter code or the data of the specific address, writing the data to the parameter code or the specific address, etc.

Check

The standard Modbus communication uses two error detection methods, in which parity is used for verification of each character, and CRC detection is used to verify one frame of data.

1. Parity

The user can configure whether the controller is odd or even parity, or no parity. This will determine how the parity bit in each character is set.

If odd or even parity is specified, the number of bits of "1" will be counted in the number of bits per character (7 data bits in ASCII mode and 8 data bits in RTU). For example, the RTU character frame contains the following 8 data bits: 1 1 0 0 0 1 0 1 , the number of the entire "1" is 4.

If even parity is used, the parity bit of the frame will be 0, and the total number of "1"s will still be four. If an odd parity is used, the parity bit of the frame will be 1, and the number of the entire "1" is five.

If no parity bit is specified, there is no parity bit during transmission and no parity check is performed. Instead of an additional stop bit, it is filled into the character frame to be transmitted.

2. CRC-16 (Cyclic Redundancy Check)

Using the RTU frame format, the frame includes a frame error detection field calculated based on the CRC method. The CRC field detects the contents of the entire frame. The CRC field is two bytes and contains a 16-bit binary value. It is calculated by the transmission device and added to the frame. The receiving device recalculates the CRC of the received frame and compares it with the value in the received CRC field. If the two CRC values are not equal, the transmission has an error.

The CRC is first stored in 0xFFFF, and then a procedure is called to process the consecutive six or more bytes in the frame with the values in the current register. Only the 8Bit data in each character is valid for the CRC, and the start and stop bits as well as the parity bit are invalid.

During the CRC generation process, each 8-bit character is individually or XORed with the contents of the register, and the result moves to the least significant bit direction, and the most significant bit is padded with 0s. The LSB is extracted and detected. If the LSB is 1, the register is individually or different from the preset value. If the LSB is 0, it is not performed. The entire process is repeated 8 times. After the last bit (bit 8) is completed, the next octet is individually different from the current value of the register. The value in the final register is the CRC value after all the bytes in the frame have been executed.

This calculation method of CRC adopts the international standard CRC check rule. When editing the CRC algorithm, the user can refer to the CRC algorithm of the relevant standard to write a CRC calculation program that truly meets the requirements.

5.2.4 Communication instruction example

Read slave parameter command code: 03H, read N words (Word), up to 20 words can be read continuously.

For example, if the slave address is 01H, the memory start address is 2100H ([C00-00]). If three consecutive words are read, the structure of the frame is described as follows:

RTU host command information:

START	3.5 bytes of transmission time
Slave address	01H
Command code	03H
Start address high	21H
Start address low	00H
High number of data	00H
Low number of data	03H
CRC CHK low	0FH
CRC CHK high	F7H
END	3.5 bytes of transmission time

RTU slave response information (normal):

START	3.5 bytes of transmission time
Slave address	01H
Command code	03H
Low number of bytes	06H
Data address 2100H high	13H
Data address 2100H low	88H
Data address 2101H high	00H
Data address 2101H low	00H
Data address 2102H high	00H
Data address 2102H low	00H
CRC CHK low	90H
CRC CHK high	A6H
END	3.5 bytes of transmission time

RTU slave response information (when abnormal):

START	3.5 bytes of transmission time
Slave address	01H
Command code	83H
error code	04H
CRC CHK low	40H
CRC CHK high	F3H
END	3.5 bytes of transmission time

Write slave parameter command code: 06H, write a word data (Word) into the specified data address, which can be used to modify the inverter parameter value.

For example: Write 5000 (1388H) to the 3000H address of the slave address 1 inverter. The structure of the frame is described as follows:

RTU host command information:

START	3.5 bytes of transmission time
Slave address	01H
Command code	06H
Write data address high	30H
Write data address low	00H
High data content	13H
Low data content	88H
CRC CHK low	8BH
CRC CHK high	9CH
END	3.5 bytes of transmission time

RTU slave response information (normal):

START	3.5 bytes of transmission time
Slave address	01H
Command code	06H
Write data address high	30H
Write data address low	00H
High data content	13H
Low data content	88H
CRC CHK low	8BH
CRC CHK high	9CH
END	3.5 bytes of transmission time

RTU slave response information (when abnormal):

START	3.5 bytes of transmission time
Slave address	01H
Command code	86H
error code	01H
CRC CHK low	83H
CRC CHK high	A0H
END	3.5 bytes of transmission time

The loop self-test command code: 06H, returns the same slave response information as the host command information, and is used to detect whether the signal transmission between the master and the slave is normal, the detection code and data can be arbitrarily set, the detection code and the frequency conversion. The parameter address of the device is irrelevant.

For example: Write 5000 (1388H) to the 0000H detection code of the slave address 1 inverter. The structure of the frame is described as follows:

RTU host command information:

START	3.5 bytes of transmission time
Slave address	01H
Command code	08H
Detection code high	00H
Detection code status	00H
Data high	13H
Data low	88H
CRC CHK low	EDH
CRC CHK high	5DH
END	3.5 bytes of transmission time

RTU slave response information (normal):

START	3.5 bytes of transmission time
Slave address	01H
Command code	08H
Detection code high	00H
Detection code status	00H
Data high	13H
Data low	88H
CRC CHK low	EDH
CRC CHK high	5DH
END	3.5 bytes of transmission time

RTU slave response information (when abnormal):

START	3.5 bytes of transmission time
Slave address	01H
Command code	88H
error code	03H
CRC CHK low	06H
CRC CHK high	01H
END	3.5 bytes of transmission time

5.2.5 Communication data list

RD05 series function parameter address representation rules:

The inverter function parameter number is the register address, which is divided into two parts: high byte and low byte. The high byte indicates the group number of the function parameter, and the low byte indicates the serial number of the function parameter, which needs to be converted into hexadecimal.

Address field high byte definition:

Parameter group code number	Parameter address of this group
F00 environment application parameter group	0x00xx (not stored in EEPROM) 0x10xx (stored in EEPROM)
F01 basic parameter group	0x01xx (not stored in EEPROM) 0x11xx (stored in EEPROM)
F02 motor 1 parameter group	0x02xx (not stored in EEPROM) 0x12xx (stored in EEPROM)
F03 vector control parameter group	0x03xx (not stored in EEPROM) 0x13xx (stored in EEPROM)
F04 V/F control parameter group	0x04xx (not stored in EEPROM) 0x14xx (stored in EEPROM)
F05 input terminal parameter group	0x05xx (not stored in EEPROM) 0x15xx (stored in EEPROM)
F06 output terminal parameter group	0x06xx (not stored in EEPROM) 0x16xx (stored in EEPROM)
F07 operation control parameter group	0x07xx (not stored in EEPROM) 0x17xx (stored in EEPROM)
F08 auxiliary control 1 parameter group	0x08xx (not stored in EEPROM) 0x18xx (stored in EEPROM)
F09 Auxiliary Control 2 Parameter Group	0x09xx (not stored in EEPROM) 0x19xx (stored in EEPROM)
F10 protection parameter group	0x0Axx (not stored in EEPROM) 0x1Axx (stored in EEPROM)
F11 keyboard parameter group	0x0Bxx (not stored in EEPROM) 0x1Bxx (stored in EEPROM)
F12 communication parameter group	0x0Cxx (not stored in EEPROM) 0x1Cxx (stored in EEPROM)
F13 Process PID Control Parameter Group	0x0Dxx (not stored in EEPROM) 0x1Dxx (stored in EEPROM)
F14 multi-speed and simple PLC function	0x0Exx (not stored in EEPROM) 0x1Exx (stored in EEPROM)
C00 basic monitoring parameter group	0x2100
C01 fault monitoring parameter group	0x2200
C02 application monitoring parameter group	0x2300

C03 Maintenance Monitoring Parameter Group	0x2400
MODBUS communication control parameter group	0x30xx or 0x20xx
Input and output interface communication group	0x34xx
Extended fault and power down parameter set	0x36xx

Note: Due to the possibility of frequent rewriting of parameter values in communication, if the EEPROM is frequently stored, the lifetime will be reduced. For the user, some function code parameters are in the communication mode, no need to store, just change the value in the on-chip RAM to meet the usage requirements. The RD05 communication protocol stipulates that when the write command (06H) is used, if the highest bit of the function code parameter address field is 0, it is only written into the inverter RAM, and the power-down is not stored. If the function code parameter address field high nibble is 1, Write to the EEPROM, that is, power down storage.

For example, the function parameter [F00.14] is rewritten, and it is not stored in the EEPROM. The address is represented as 000EH and stored in the EEPROM. The address is expressed as 100EH.

MODBUS communication control parameter group address description:

Address	Name	Read/Write (R/W)	Dimension (range)	Description
0x2000 /0x3000	Given frequency	R/W	0.01Hz (0.00~320.00)	Communication given frequency
0x2001 /0x3001	Command given	W	0x0000 (0x0~0x0103)	0x0000: invalid 0x0001: Forward run 0x0002: Reverse run 0x0003: Forward jog 0x0004: Reverse jog 0x0005: Deceleration stop 0x0006: Free stop 0x0007: Reset command 0x0008: Run prohibition command Communication writes to the 3001 address, the inverter is free to stop, and it needs to write 9 to 3001 or re-power on before it can run. 0x0009: Run permission command 0x0101: Equivalent to F2.07 = 1 [rotation parameter auto-tuning], plus run command 0x0102: Equivalent to F5.07 = 2 [static parameter auto-tuning], plus run command 0x0103: Equivalent to F5.07 = 3 [stator resistance setting], plus run command
0x2002 /0x3002	Inverter status information	R	Binary	Bit0: 0-stop 1-run Bit1: 0-non-acceleration 1-acceleration Bit2: 0-non-deceleration 1-deceleration Bit3: 0-forward 1-reverse Bit4: 0-Inverter normal 1-Faulty Bit5: 0-unlocked state 1-locked state, Bit6: 0-No warning 1-Alarm
0x2003 /0x3003	Frequency inversion fault code	R	0 (0~127)	The corresponding value of the communication read fault code
0x2004 /0x3004	Upper limit frequency	R/W	0.01Hz (0.00~320.00)	Communication given upper limit frequency
0x2005 /0x3005	Torque setting	R/W	0.0% (0.0~100.0%)	Communication given torque setting
0x2006 /0x3006	Torque control forward speed limit	R/W	0.0% (0.0~100.0%)	Communication given torque control forward speed limit
0x2007 /0x3007	Torque control reverse speed limit	R/W	0.0% (0.0~100.0%)	Communication given torque control reverse speed limit
0x2008 /0x3008	PID given	R/W	0.0% (0.0~100.0%)	The communication gives a given PID.
0x2009 /0x3009	PID feedback	R/W	0.0% (0.0~100.0%)	Communication gives the amount of PID feedback.
0x200A /0x300A	Voltage-frequency separation voltage value setting	R/W	0.0% (0.0~100.0%)	Frequency conversion power supply application parameters
0x200E /0x300E	Acceleration time 1	R/W	0.00s (0.00~600.00s)	Read and write the value of F01.22
0x200F /0x300F	Deceleration time 1	R/W	0.00s (0.00~600.00s)	Read and write the value of F01.23
0x2010 /0x3010	Fault warning, alarm number	R	0 (0~65535)	1~127 is the fault code, 128-159 is the warning code, and 0 is the faultless code.
0x2011 /0x3011	Torque current component	R	0.0% (0.0~400.0%)	Belt special machine application parameters
0x2012 /0x3012	Torque filtering time	R/W	0.000s (0.000~6.000s)	Read and write the value of F03.47
0x2013 /0x3013	Reserved	R/W	--	Use with optional card

0x2014 /0x3014	Reserved	R/W	--	Use with optional card
0x2015 /0x3015	Reserved	R/W	--	Use with optional card
0x2016 /0x3016	Reserved	R/W	--	Use with optional card
0x2017 /0x3017	Reserved	R/W	--	Use with optional card
0x2018 /0x3018	Terminal output control	W	Binary	For the output terminal function, select 30 [Communication Control Output] for F6.20~F24. Bit0: Y terminal Bit1: Relay Bit2: Extend Y1 Bit3: Extended Relay
0x2019 /0x3019	AO output	W	0.01 (0~100.00)	F06.01=18[AO function output selection=communication output]
0x201A /0x301A	Reserved	W	0.01 (0~100.00)	F06.11=18[Extended AO function output selection = communication output]
0x201B /0x301B	Custom 1	R/W	0 (0~65535)	Use with the host computer
0x201C /0x301C	Custom 2	R/W	0 (0~65535)	Use with the host computer
0x201D /0x301D	Custom 3	R/W	0 (0~65535)	Use with the host computer
0x201E /0x301E	Custom 4	R/W	0 (0~65535)	Use with the host computer
0x201F /0x301F	Custom 5	R/W	0 (0~65535)	Use with the host computer

5.2.6 Error code

The fault codes for MODBUS communication are shown in the table below. After the fault occurs, please correct the cause of the fault and start communication again.

error code	Description
1	Command code error
2	Reserved
3	CRC check error
4	Illegal address
5	Illegal data
6	Running parameters cannot be changed
7	Reserved
8	The drive is busy (EEPROM is being stored)
9	Parameter value is out of limits
10	Reserved parameters cannot be changed
11	The number of bytes read is incorrect.

6 Troubleshooting

6.1 Safety Precautions

	<ul style="list-style-type: none"> ● This product has a dangerous voltage and it controls a potentially dangerous moving mechanism. Failure to follow these instructions or not complying with the requirements of this manual may result in personal injury or death, damage to the product and associated systems. ● Only trained personnel are allowed to operate this product. Before using this product, be familiar with all the safety instructions and operating instructions in this manual. Correct operation and maintenance are reliable for safe and stable operation of this product. Guarantee. ● Do not perform wiring work while the power is on, otherwise there is a danger of death due to electric shock. When wiring, inspection, maintenance, etc., please cut off the power of all related equipment and confirm that the DC voltage of the main circuit has dropped to Safety level, wait 5 minutes before performing related work.
---	---

 Caution	<ul style="list-style-type: none"> ● Prevent children and the public from coming into contact with or close to the product. ● This product can only be used in accordance with the manufacturer's specified use. It may not be used in special fields such as emergency, rescue, shipbuilding, medical, aviation, nuclear facilities, etc. without permission. ● Unauthorized modifications and use of spare parts not sold or recommended by the manufacturer of this product may result in malfunction.
<div style="border: 1px solid black; padding: 2px; display: inline-block;">Important</div>	<ul style="list-style-type: none"> ● Please be sure to deliver this manual to the actual user to ensure that the actual user can read this manual carefully before use. ● Before installing and commissioning the drive, please read and fully understand these safety rules and warning signs.

6.2 Fault, warning, prompt code type

- When the operation of the inverter or motor is abnormal, first check the code and prompt on the keyboard.
- If you cannot solve the problem by reading the instruction manual, please confirm the following items and contact our agent or call our customer service phone (contact information on the back cover).

Model of the inverter

Software version

Date of purchase

The contents of the consultation (the situation of the failure)

Refer to the table below for descriptions of faults, warnings, and prompts that occur during operation of the drive.

Table 6.1 Faults, Warning, and Prompt Code Types

Type	The action of the inverter when the fault occurs
Fault	When a fault is detected, the following conditions will occur, and the inverter will not operate until the inverter returns to the normal state by fault reset. <ul style="list-style-type: none"> ● A fault message will appear on the keyboard. ● The inverter cuts off the output and the motor stops freely. ● When a fault is detected, the terminal that sets F6.01~F6.02 = 1 [output terminal function selection = fault output] turns ON. If it is not set, the terminal will not output a signal even if a fault is detected.
Warning	When a warning is detected, the following conditions occur and no fault reset operation is required. <ul style="list-style-type: none"> ● A warning message will appear on the keyboard. ● The inverter can continue to run. ● When a fault is detected, the terminal that sets F6.01~F6.02 = 29 [output terminal function selection = warning output] turns ON. If it is not set, the terminal will not output a signal even if a warning is detected.
Note	<ul style="list-style-type: none"> ● When powering up, "Pon" is displayed to remind the control panel to be powered. ● When the factory settings are restored, "SAvE" is displayed. ● After the self-learning setting, "T-00" is displayed to enter the self-learning state. ● "CoPy" is displayed when the parameter is uploaded, and "LoAd" is displayed when the parameter is downloaded.

6.3 Fault, Warning, Prompt Code List

The fault, warning and prompt codes are shown in Table 6.2. When the keyboard displays the characters in the table, the detailed reasons and countermeasures of the fault can be viewed according to the reference source to the corresponding page number.

Note: The numbers in parentheses in the code column are fault codes or warning codes (Dec stands for decimal).

Table 6.2 List of faults, warnings, and prompt codes

Keyboard Display(DEC.)	Fault Name	Fault Type	Reference source
E.SC1 (1)	System failure during acceleration	Fault	
E.SC2 (2)	System failure during deceleration	Fault	
E.SC3 (3)	System failure in constant speed	Fault	
E.SC4 (4)	System failure in downtime	Fault	
E.OC1 (5)	Overcurrent in acceleration	Fault	
E.OC2 (6)	Overcurrent during deceleration	Fault	
E.OC3 (7)	Overcurrent at constant speed	Fault	
E.OC4 (8)	RD05 software overcurrent	Fault	
E.OU1 (9)	Over-voltage during acceleration	Fault	
E.OU2 (10)	Over-voltage during deceleration	Fault	
E.OU3 (11)	Over-voltage at constant speed	Fault	
E.LU (13)	Under-voltage in operation	Fault	
E.OL1 (14)	Motor overload	Fault	
E.OL2 (15)	Inverter overload 1	Fault	
E.OL3 (16)	Inverter overload 2 CBC continues to generate	Fault	
E.OL4 (17)	Inverter overload 3	Fault	
E.ILF (18)	Input phase loss	Fault	
E.OLF (19)	Three-phase output loss	Fault	
E.OLF1 (20)	U phase output phase loss	Fault	

E.OLF2 (21)	V phase output phase loss	Fault	
E.OLF3 (22)	W phase output phase loss	Fault	
E.OH1 (30)	Rectifier module is over-temperature	Fault	
E.OH2 (31)	IGBT module is over- temperature	Fault	
E.OH3 (32)	Motor is over- temperature	Fault	
E.EF (33)	External fault	Fault	
E.CE (34)	Modbus communication failure	Fault	
E.HAL1 (35)	U phase zero drift	Fault	
E.HAL2 (36)	V phase zero drift	Fault	
E.HAL3 (38)	Three-phase current and not 0 fault	Fault	
E.HAL (37)	W phase zero drift	Fault	
E.SGxx (40)	Reserved	Fault	
E.FSG (41)	Short circuit to ground	Fault	
E.PID (42)	Fan short circuit	Fault	
E.COP (43)	PID feedback disconnection	Fault	
E.PG1 (44)	Parameter copy failure	Fault	
E.PG2 (44)	Encoder Z pulse failure	Fault	
E.PG3 (44)	Rotation check error	Fault	
E.PG4 (44)	Rotational disconnection	Fault	
E.PG5 (44)	ABZ encoder disconnection	Fault	
E.PG6 (44)	Spindle encoder disconnection	Fault	
E.PG7 (44)	Spindle encoder Z pulse error fault	Fault	
E.PG8 (44)	Encoder Z pulse logic fault	Fault	
E.PG9 (44)	Spindle encoder Z pulse logic fault	Fault	
E.PG10 (44)	Encoder Z pulse disconnection	Fault	
E.BRU (50)	Brake unit failure	Fault	
E.TExx (52)	Self-tuning output current overrun	Fault	
E.IAE1 (71)	Motor angle learning fault 1	Fault	
E.IAE2 (72)	Motor angle learning fault 2	Fault	
E.IAE3 (73)	Motor angle learning fault 3	Fault	
E.PST1 (74)	PMSM out of step fault 1	Fault	
E.PST2 (75)	PMSM out of step fault 2	Fault	
E.PST3 (76)	PMSM out of step fault 3	Fault	
E.DEF (77)	Speed deviation is too large	Fault	
E.SPD (78)	Rapid failure	Fault	
E.LD1 (79)	Load protection 1	Fault	
E.LD2 (80)	Load protection 2	Fault	
E.CPU (81)	CPU timeout failure	Fault	
E.LOC (85)	Chip lock	Fault	
E.EEP (86)	Parameter storage failure	Fault	
E.BUS1 (91)	Expansion card A disconnected	Fault	
E.BUS2 (92)	Expansion card B is disconnected	Fault	
E.BUS3 (93)	CAN expansion card failure	Fault	
E.BUS4 (94)	Other expansion card failure	Fault	
E.BUS5 (95)	Other expansion card failure	Fault	
E.BUS6 (96)	Other expansion card disconnection	Fault	
E.CP1 (97)	Monitor compare output 1 fault	Fault	
E.CP2 (98)	Monitor compare output 2 fault	Fault	
E.DAT (99)	Parameter setting error	Fault	
E.FA1 (110)	External extension reserve 1	Fault	
E.FA2 (111)	External extension reserve 2	Fault	
E.FA3 (112)	External extension reserve 3	Fault	
E.FA4 (113)	External extension reserve 4	Fault	
E.FA5 (114)	External extension reserve 5	Fault	
E.FA6 (115)	External extension reserve 6	Fault	
E.FA7 (116)	External extension reserve 7	Fault	
E.FA8 (117)	External extension reserve 8	Fault	
The following are warnings			
A.LU1 (128)	Undervoltage during shutdown	Warning	
A.OU (129)	Over-voltage during shutdown	Warning	
A.ILF (130)	Input phase loss	Warning	
A.PID (131)	PID feedback disconnection	Warning	

A.EEP (132)	Parameter storage warning	Warning	
A.DEF (133)	Speed deviation is too large	Warning	
A.SPD (134)	Speed warning	Warning	
A.GPS1 (135)	GPS lock machine	Warning	
A.GPS2 (136)	GPS disconnection	Warning	
A.CE (137)	External warning	Warning	
A.LD1 (138)	Load protection 1	Warning	
A.LD2 (139)	Load protection 2	Warning	
A.BUS (140)	Expansion card disconnection warning	Warning	
A.OH1 (141)	Module over- temperature warning	Warning	
A.OH3 (142)	Motor over temperature warning	Warning	
A.RUN1 (143)	Running warning 1	Warning	
A.RUN2 (158)	Jog terminal start protection	Warning	
A.RUN3 (159)	Terminal start protection	Warning	
A.PA2 (144)	External keyboard disconnection warning	Warning	
A.COP (145)	Parameter copy warning	Warning	
A.CP1 (146)	Monitor comparison output 1 warning	Warning	
A.CP2 (147)	Monitor comparison output 2 warning	Warning	
A.FA1 (150)	External extension reserve 1	Warning	
A.FA2 (151)	External extension reserve 2	Warning	
A.FA3 (152)	External extension reserve 3	Warning	
A.FA4 (153)	External extension reserve 4	Warning	
A.FA5 (154)	External extension reserve 5	Warning	
A.FA6 (155)	External extension reserve 6	Warning	

6.4 Fault

In the event of a fault, the inverter cannot be operated. The following table explains the cause of the fault and the corresponding measures.

Note: All faults must be reset by a fault reset operation.

Code	Name	Reason	Countermeasures
E.SC1	Accelerated system failure	Short circuit on the output side of the inverter or short circuit to ground	Check the main circuit to eliminate the short circuit
		Inverter output cable exceeds the maximum allowed	Shorten the output cable or increase the output reactor
		Malfunction caused by interference	Check wiring of control circuit, main circuit and ground to eliminate interference sources
		Motor damage	Measure the resistance between the motor wires and replace the motor immediately if it is turned on.
		Torque boost value is too large	Decrease F04.01 [torque boost value]
		Excessive load	Reduce load or replace large capacity inverter Impact load needs to reduce the load change frequency or replace the larger capacity inverter
		Acceleration time is too short	Increase F01.22 [acceleration time] Replace the large capacity inverter
Note: This fault is detected when the inverter output is short-circuited, short-circuited to ground or the IGBT module fails.			
Code	Name	Reason	Countermeasures
E.SC2	System failure during deceleration	Short circuit on the output side of the inverter or short circuit to ground	Check the main circuit to eliminate the short circuit
		Inverter output cable exceeds the maximum allowed	Shorten the output cable or increase the output reactor
		Malfunction caused by interference	Check wiring of control circuit, main circuit and ground to eliminate interference sources
		Motor damage	Measure the resistance between the motor wires and replace the motor immediately if it is turned on.
		Torque boost value is too large	Decrease F04.01 [torque boost value]
		Excessive load	Reduce load or replace large capacity inverter Impact load needs to reduce the load change frequency or replace the larger capacity inverter
		Deceleration time is too short	Increase F01.23 [Deceleration time] Replace the large capacity inverter
Note: This fault is detected when the inverter output is short-circuited, short-circuited to ground or the IGBT module fails.			
Code	Name	Reason	Countermeasures
E.SC3	System failure at constant speed	Short circuit on the output side of the inverter or short circuit to ground	Check the main circuit to eliminate the short circuit
		Inverter output cable exceeds the maximum allowed	Shorten the output cable or increase the output reactor
		Malfunction caused by interference	Check wiring of control circuit, main circuit and ground to

			eliminate interference sources
		Motor damage	Measure the resistance between the motor wires and replace the motor immediately if it is turned on.
		Torque boost value is too large	Decrease F04.01 [torque boost value]
		Excessive load	Reduce load or replace large capacity inverter Impact load needs to reduce the load change frequency or replace the larger capacity inverter
Note: This fault is detected when the inverter output is short-circuited, short-circuited to ground or the IGBT module fails.			
Code	Name	Reason	Countermeasures
E.SC4	Downtime system failure	Short circuit on the output side of the inverter or short circuit to ground	Check the main circuit, eliminate the short circuit, and re-power
		Malfunction caused by interference	Check wiring of control circuit, main circuit and ground to eliminate interference sources
		The control board is disturbed or damaged	Cannot be eliminated after power failure restart failure, seek technical support
Note: This fault is detected when the inverter is shorted to ground or the IGBT module is faulty.			
Code	Name	Reason	Countermeasures
E.OC1	Accelerating overcurrent fault	Excessive load	Reduce load or replace large capacity inverter Impact load needs to reduce the load change frequency or replace the larger capacity inverter
		Short circuit on the output side of the inverter or short circuit to ground	Check the main circuit to eliminate the short circuit
		Motor damage	Measure the resistance between the motor wires and replace the motor immediately if it is turned on.
		Acceleration time is too short	Increase F01.22 [acceleration time] Replace the large capacity inverter
		Inverter output cable exceeds the maximum allowed	Shorten the output cable or increase the output reactor
		Malfunction caused by interference	Check wiring of control circuit, main circuit and ground to eliminate interference sources
Note: This fault is detected when the inverter output current exceeds the overcurrent point.			
Code	Name	Reason	Countermeasures
E.OC2	Overcurrent fault during deceleration	Excessive load	Reduce load or replace large capacity inverter Impact load needs to reduce the load change frequency or replace the larger capacity inverter
		Short circuit on the output side of the inverter or short circuit to ground	Check the main circuit to eliminate the short circuit
		Motor damage	Measure the resistance between the motor wires and replace the motor immediately if it is turned on.
		Deceleration time is too short	Increase F01.23 [Deceleration time] Replace the large capacity inverter
		Inverter output cable exceeds the maximum allowed	Shorten the output cable or increase the output reactor
		Malfunction caused by interference	Check wiring of control circuit, main circuit and ground to eliminate interference sources
Note: This fault is detected when the inverter output current exceeds the overcurrent point.			
Code	Name	Reason	Countermeasures
E.OC3	Constant speed overcurrent fault	Excessive load	Reduce load or replace large capacity inverter Impact load needs to reduce the load change frequency or replace the larger capacity inverter
		Short circuit on the output side of the inverter or short circuit to ground	Check the main circuit to eliminate the short circuit
		Motor damage	Measure the resistance between the motor wires and replace the motor immediately if it is turned on.
		Inverter output cable exceeds the maximum allowed	Shorten the output cable or increase the output reactor
		Malfunction caused by interference	Check wiring of control circuit, main circuit and ground to eliminate interference sources
Note: This fault is detected when the inverter output current exceeds the overcurrent point.			
Code	Name	Reason	Countermeasures
E.OU1	Accelerating overvoltage fault	Power supply voltage is too high	Reduce the supply voltage to the specified range
		Inverter output or motor short to ground	Check main circuit wiring to eliminate short circuit
		Acceleration time is too short	Determine if the fault is detected when the sudden acceleration stops Increase F01.22 [acceleration time]
		Large braking load	Brake resistor device
		Surge voltage mixed in the input voltage	Adding reactor on the input side
		Improper setting of speed tracking parameters	Modify the speed tracking related parameters (F07.25~F07.28)
Note: This fault is detected when the bus voltage exceeds the overvoltage point. The overvoltage point is 820V for three-phase input and 400V for single-phase input.			

Code	Name	Reason	Countermeasures
E.OU2	Overvoltage fault during deceleration	Power supply voltage is too high	Reduce the supply voltage to the specified range
		Inverter output or motor short to ground	Check main circuit wiring to eliminate short circuit
		Deceleration time is too short	Increase F01.23 [Deceleration time] Brake resistor device
		Large braking load	Brake resistor device
		Surge voltage mixed in the input voltage	Adding reactor on the input side
		Improper setting of speed tracking parameters	Modify the speed tracking related parameters (F07.25~F07.28)
Note: This fault is detected when the bus voltage exceeds the overvoltage point. The overvoltage point is 820V for three-phase input and 400V for single-phase input.			
E.OU3	Constant speed overvoltage fault	Power supply voltage is too high	Reduce the supply voltage to the specified range
		Inverter output or motor short to ground	Check main circuit wiring to eliminate short circuit
		Large braking load	Brake resistor device
		Surge voltage mixed in the input voltage	Adding reactor on the input side
		Improper setting of speed tracking parameters	Modify the speed tracking related parameters (F07.25~F07.28)
Note: This fault is detected when the bus voltage exceeds the overvoltage point. The overvoltage point is 820V for three-phase input and 400V for single-phase input.			
E.OU4	Shutdown overvoltage fault	Power supply voltage is too high	Reduce the supply voltage to the specified range
		Inverter output or motor short to ground	Check main circuit wiring to eliminate short circuit
		Surge voltage mixed in the input voltage	Adding reactor on the input side
Note: This fault is detected when the bus voltage exceeds the overvoltage point. The overvoltage point is 820V for three-phase input and 400V for single-phase input.			
E.LU	Undervoltage in operation	Power outage or instantaneous power outage	Reset and restart after checking the power supply
		Input power phase loss	Confirm main circuit wiring
		Input voltage fluctuation is too large	Improve the power supply to meet the rated voltage of the inverter
			If there is no problem with the main circuit power supply, check if there is a problem with the electromagnetic contactor on the main circuit side.
Note: This fault is detected when the bus voltage is lower than the undervoltage protection point (F10.19) while the inverter is running.			
E.OL1	Motor overload	Excessive load	Reduce the load Appropriate increase of motor overload protection curve coefficient
		Whether the acceleration and deceleration time settings are too small	Increase F01.22, F01.23 [addition and deceleration time]
		Torque boost value setting is too large	Lower F04.01 [torque boost value]
		V/F curve setting is not suitable	Determine the relationship between the voltage and frequency set by the V/F curve, and modify F04.00 [V/F curve setting] If you use a custom V/F curve, modify the parameters related to the custom V/F curve (F04.10~F04.19)
		The characteristics of the electronic thermal relay are inconsistent with the characteristics of the motor load.	Use an external thermal relay
		Input phase loss causes abnormal output current	Check the main circuit to eliminate input phase loss
E.OL2	Inverter overload 1	Excessive load	Reduce the load Appropriate increase of motor overload protection curve coefficient
		Whether the acceleration and deceleration time settings are too small	Increase F01.22, F01.23 [addition and deceleration time]
		Torque boost value setting is too large	Lower F04.01 [torque boost value]
		V/F curve setting is not suitable	Determine the relationship between the voltage and frequency set by the V/F curve, and modify F04.00 [V/F curve setting] If you use a custom V/F curve, modify the parameters related to the custom V/F curve (F04.10~F04.19)
		Input phase loss causes abnormal output current	Check the main circuit to eliminate input phase loss
E.OL3	Inverter CBC overload 2	Excessive load	Reduce the load Appropriate increase of motor overload protection curve coefficient
		Whether the acceleration and deceleration time settings are too small	Increase F01.22, F01.23 [addition and deceleration time]
		Torque boost value setting is too large	Lower F04.01 [torque boost value]

		V/F curve setting is not suitable	Determine the relationship between the voltage and frequency set by the V/F curve, and modify F04.00 [V/F curve setting] If you use a custom V/F curve, modify the parameters related to the custom V/F curve (F04.10~F04.19)
		Input phase loss causes abnormal output current	Check the main circuit to eliminate input phase loss
Code	Name	Reason	Countermeasures
E.ILF	Input phase loss	The main circuit terminal of the inverter is loose.	Tighten the screw and restart it.
		Input voltage fluctuation is too large	Improve the power supply to meet the rated voltage of the inverter If there is no problem with the main circuit power supply, check if there is a problem with the electromagnetic contactor on the main circuit side.
		Three-phase voltage imbalance	Check if there is a problem with the input voltage and improve the power imbalance.
Note: The F10.20 [Input, Output Phase Loss Protection Selection] ten-digit selection is used to enable the input phase loss fault detection function.			
Code	Name	Reason	Countermeasures
E.OLF	All output phase loss	Two-phase and above disconnection on the output side of the inverter	Check if the three connected wires of the motor are normal. Check if the inverter output terminal screw is loose
		Motor damage	Measure the resistance between the motor wires and replace the motor immediately if it is turned on.
		Motor power is too small	Reset the drive or motor power
Note: Select whether to enable the output phase loss detection function by F10.20 [Input, Output Phase Loss Protection Selection].			
Code	Name	Reason	Countermeasures
E.OLF 1	U phase output phase loss	U phase disconnection on the output side of the inverter	Check if the motor U connection line is normal Check if the inverter output terminal screw is loose
		Motor damage	Measure the resistance between the motor wires and replace the motor immediately if it is turned on.
		Motor power is too small	Reset the drive or motor power
Code	Name	Reason	Countermeasures
E.OLF 2	V phase output phase loss	V phase disconnection on the output side of the inverter	Check if the motor V connection line is normal Check if the inverter output terminal screw is loose
		Motor damage	Measure the resistance between the motor wires and replace the motor immediately if it is turned on.
		Motor power is too small	Reset the drive or motor power
Code	Name	Reason	Countermeasures
E.OLF 3	W phase output phase loss	W phase disconnection on the output side of the inverter	Check if the motor W connection line is normal Check if the inverter output terminal screw is loose
		Motor damage	Measure the resistance between the motor wires and replace the motor immediately if it is turned on.
		Motor power is too small	Reset the drive or motor power
Code	Name	Reason	Countermeasures
E.OH1	Rectifier module overheated	Ambient temperature is too high	Reduce the ambient temperature of the inverter
		Excessive load	Reduce the load
		Fan failure	Check whether the fan is running normally. If the fan is abnormal, you need to replace the fan and then power on.
Code	Name	Reason	Countermeasures
E.OH2	IGBT module overheating	Ambient temperature is too high	Reduce the ambient temperature of the inverter
		Excessive load	Reduce the load Lower F01.40 [carrier set value]
		Fan failure	Check whether the fan is running normally. If the fan is abnormal, you need to replace the fan and then power on.
Code	Name	Reason	Countermeasures
E.OH3	Motor overheating	Motor heat transfer is abnormal	Improve motor cooling
		Excessive load	Reduce the load
Note: This function needs to be implemented with an IO expansion card. This fault is reported when the motor temperature exceeds F10.27 [Motor overheat warning detection level]. Select which temperature sensor (PT1000/KTY84) to use by F10.26 [Motor overheat protection selection], and F10.26 [Motor overheat protection selection] ten setting to detect the motor action when this fault is detected.			
Code	Name	Reason	Countermeasures
E.EF	External fault	Multi-function input terminal inputs external fault signal	Troubleshoot external faults External fault function that cancels the function of the multi-function input terminal
Note: This external fault detection can be realized by configuring any X terminal with F05.00~F05.09.			
Code	Name	Reason	Countermeasures
E.CE	Modbus communication failure	Communication cable failure, such as short circuit, disconnection, etc.	Check if the communication connection is normal
		Communication data is abnormal due to interference	Check whether the grounding wire of the whole machine is normal.

Code	Name	Reason	Countermeasures
			Change the communication cable with shield
Note: If the communication data is incorrect and exceeds the time set by F12.06 [Modbus Communication Timeout], the fault is reported. The motor action can be detected when this fault is detected by F12.07 [Communication Disconnection Processing].			
E.HAL 1	U phase zero drift	Interference causes U phase current detection signal to be abnormal Inverter hardware is abnormal	Check the grounding of the whole machine to eliminate the U-phase Hall interference source Seek technical support from manufacturers
E.HAL 2	V phase zero drift	Interference causes the V phase current detection signal to be abnormal Inverter hardware is abnormal	Check the grounding of the whole machine to eliminate the V-phase Hall interference source Seek technical support from manufacturers
E.HAL 3	W phase zero drift	Interference causes W phase current detection signal to be abnormal Inverter hardware is abnormal	Check the grounding of the whole machine to eliminate the W-phase Hall interference source Seek technical support from manufacturers
E.HAL	Three-phase current detection fault	Interference causes a phase current detection signal to be abnormal Short circuit between motors Inverter output terminal screw loose Inverter hardware is abnormal	Check the grounding of the whole machine to eliminate the interference source Check motor wiring and power cycle Re-power on after tightening the screws Seek technical support from manufacturers
E.SG	Output short to ground	Motor burned or insulation aging The distributed capacitance between the output cable and the ground terminal is large, and the leakage current becomes large. Inverter hardware failure	Measure the line resistance of the motor and replace the motor if it is conductive or the insulation is degraded. Reduce the carrier frequency when the cable length exceeds 100 m. Seek technical support from manufacturers
Note: This fault shows E.SGxx. When xx is less than 32, U is short-circuited relative to ground. When it is greater than 32, V is short-circuited relative to ground.			
E.FSG	Fan shorted to ground	Inverter cooling fan is damaged	If the fault is not eliminated after the power is turned off, seek technical support from the manufacturer.
E.PID	PID feedback disconnection fault	PID disconnection detection related parameters are set incorrectly Improper wiring of PID feedback Sensor for PID feedback fails The PID feedback loop of the inverter control board is abnormal.	Adjust F13.27 [Wire break detection upper limit], F13.28 [Wire break detection lower limit], and F13.26 [Wire break detection time] Confirm that the PID feedback wiring is normal. Check if the sensor is abnormal Seek technical support from manufacturers
Note: The PID feedback input is not within the range set by F13.27 [Disconnection Detection Upper Limit] and F13.28 [Disconnection Detection Lower Limit], and is reported after exceeding the setting value of F13.26 [Disconnection Detection Time]. The fault. The motor action can be detected when the fault is detected by F13.25 [PID feedback disconnection processing].			
E.EEP	E.EEPROM failure	Read and write parameters to receive interference during EEPROM operation E. EEPROM hardware has failed	Re-read and write parameters after checking and eliminating interference sources Power off and restart the inverter to confirm whether the fault will still occur. The fault still occurs after restarting, seeking technical support from the manufacturer.
E.BRU	Brake unit failure	Braking resistor resistance is small Brake unit failure	Replace the braking resistor with a larger resistance Seek technical support from manufacturers
E.COP	Parameter copy failure	communication fail The inverter model or software version does not match the keyboard storage parameters. Keyboard parameter copy hardware failure	Confirm that the keyboard and inverter are connected properly, and re-copy after plugging and unplugging. Re-copy the parameters before downloading to the inverter Replace the keyboard and still can't copy and seek technical support from the manufacturer.
E.PG0 1	PG parameter setting error	Improper encoder ratio setting	Reset F02.35 [transfer ratio numerator] and F02.36 [gear ratio denominator] so that the ratio is in the range of 0.01~100
E.PG0 2	Encoder Z pulse failure	ABZ encoder wiring is incorrect, or disconnection occurs	Check the encoder wiring for problems
			Countermeasures

E.PG0 3	Rotation check error	There is a strong interference source that causes problems with data transmission.	Check the grounding of the whole machine to eliminate the interference source
		The resolver card is not wired correctly, or the cable is broken.	Check if there is a problem with the resolver wiring
Code	Name	Reason	Countermeasures
E.PG0 4	Rotational disconnection	The resolver card is not wired correctly, or the cable is broken.	
Note: The fault is reported after detecting the resolver error signal for F02.38 [encoder disconnection detection time].			
Code	Name	Reason	Countermeasures
E.PG0 5	ABZ encoder disconnection	ABZ encoder wiring is incorrect, or disconnection occurs	Check the encoder wiring for problems
		The motor electromagnetic brake is in the brake state	Open the brake
Note: This fault is reported after detecting that the ABZ encoder has no signal and continues to F02.38 [encoder disconnection detection time].			
Code	Name	Reason	Countermeasures
E.PG0 6	Spindle encoder disconnection	The spindle encoder is not wired correctly or a wire break occurs.	Check the encoder wiring for problems
		The motor electromagnetic brake is in the brake state	Open the brake
Code	Name	Reason	Countermeasures
E.PG0 7	Spindle encoder Z pulse error fault	Spindle encoder Z pulse error exceeds the set value	Check if there is a problem with the resolver wiring
Note: The fault is reported after detecting the resolver error signal for F02.38 [encoder disconnection detection time].			
Code	Name	Reason	Countermeasures
E.TE1	Self-learning failure	Inverter output current exceeds upper and lower limits during self-learning	Check if the motor connection is correct
Code	Name	Reason	Countermeasures
E.IAE	Motor parameter learning failure		
Code	Name	Reason	Countermeasures
E.PST	Synchronous machine parameter learning error		
Code	Name	Reason	Countermeasures
E.DEF	Speed deviation is too large	Excessive load	Reduce the load
		ACCE and DECE time is too short	Increase F01.22, F01.23 [ACCE and DECE time]
		Improper setting of speed deviation detection parameters	Adjust F10.41 [speed deviation detection threshold] and F10.42 [speed deviation detection time]
		The motor electromagnetic brake is in the brake state	Open the brake
Note: The percentage of the output motor speed relative to F01.10 [maximum frequency] is greater than F10.41 [speed deviation detection threshold], and the fault is reported after F10.42 [speed deviation detection time]. This fault detection can be enabled by F10.40 [Speed deviation excessive protection action] and the motor operation mode when the fault is detected can be set.			
Code	Name	Reason	Countermeasures
E.SPD	Rapid failure	Improper setting of encoder line number or pole number	Adjust F02.33 [ABZ encoder line number] or F02.34 [rotation pole number]
		Improper setting of parameters related to rapid detection	Adjust F10.44 [Flying Detection Threshold] and F10.45 [Fast Detection Time]
Note: The percentage of the output motor speed relative to F01.10 [maximum frequency] is greater than F10.44 [flying detection threshold], and the fault is reported after F10.45 [flying detection time]. This fault detection can be enabled by F10.43 [Fast protection action] and the motor operation mode when the fault is detected can be set.			
Code	Name	Reason	Countermeasures
E.LD1	Load warning 1	A failure occurred on the machine side, such as a broken belt pulley.	Confirm the mechanical condition and eliminate the cause of the malfunction.
		Load warning 1 parameter setting is improper	Adjust F10.33 [load warning detection level 1] and F10.34 [load warning detection detection time 1]
Note: The output current of the inverter exceeds F10.33 [load warning detection level 1], and the duration exceeds F10.34 [load warning detection detection time 1], and the fault is reported. This fault detection can be enabled by F10.32 [Load Detection Warning Setting] and tens of digits, and the motor operation mode when the fault is detected can be set.			
Code	Name	Reason	Countermeasures
E.LD2	Load warning 2	A failure occurred on the machine side, such as a broken belt pulley.	Confirm the mechanical condition and eliminate the cause of the malfunction.
		Load warning 2 parameter settings are improper	Adjust F10.35 [load warning detection level 2] and F10.36 [load warning detection detection time 2]
Note: The inverter output current exceeds F10.35 [load warning detection level 2], and the duration exceeds F10.36 [load warning detection detection time 2], and the fault is reported. The fault detection can be enabled and the motor operation mode when the fault is detected can be enabled by F10.32 [Load Detection Warning Setting] and hundreds and thousands.			
Code	Name	Reason	Countermeasures
E.CPU	Software calculation timeout failure	The chip is subjected to strong interference, causing software calculation timeout	Eliminate strong interference sources, power off and restart
		Chip hardware problem	Seek technical support from manufacturers

Code	Name	Reason	Countermeasures
E.LOC	Chip lock failure	Software version does not match the control board	Seek technical support from manufacturers
Code	Name	Reason	Countermeasures
E.BUS 1	Expansion card A disconnected	There is a strong interference source that causes problems with data transmission.	Check the grounding of the whole machine to eliminate the interference source
		Expansion card A is not wired correctly, or disconnection occurs	Check if there is a problem with the expansion card A wiring.
Note: The motor action can be detected when the fault is detected by the F12.50 [Extension Card Communication Disconnection Processing] unit setting.			
Code	Name	Reason	Countermeasures
E.BUS 2	Expansion card B is broken	There is a strong interference source that causes problems with data transmission.	Check the grounding of the whole machine to eliminate the interference source
		Expansion card B wiring is incorrect, or disconnection occurs	Check if there is a problem with the expansion card B wiring.
Note: The motor action can be detected when the fault is detected by the F12.50 [Extension Card Communication Disconnection Processing] ten-digit setting.			
Code	Name	Reason	Countermeasures
E.BUS 3	CAN expansion card failure	There is a strong interference source that causes problems with data transmission.	Check the grounding of the whole machine to eliminate the interference source
		CAN expansion card wiring is incorrect, or disconnection occurs	Check if there is a problem with the CAN expansion card wiring
Note: The motor action can be detected when the fault is detected by the F12.50 [Extension Card Communication Disconnection Processing] Hundreds setting.			
Code	Name	Reason	Countermeasures
E.CP1	Compare output 1 fault	The monitoring value 1 set by F06.50 [Comparator 1 monitor selection] exceeds F06.51 [Comparator 1 upper limit] and F06.52 [Comparator 1 upper limit].	Check the status of monitor value 1 to troubleshoot the cause.
Note: The motor operation mode when the fault is detected can be set by F06.54 [Comparator 1 Alarm Setting].			
Code	Name	Reason	Countermeasures
E.CP2	Compare output 2 fault	The monitoring value 2 set by F06.55 [Comparator 2 monitor selection] exceeds F06.56 [Comparator 2 upper limit] and F06.57 [Comparator 2 upper limit].	Check the status of the monitor value 2 and troubleshoot the cause.
Note: The motor operation mode when the fault is detected can be set by F06.59 [Comparator 2 Alarm Setting].			
Code	Name	Reason	Countermeasures
E.DAT	Parameter setting error	Parameter value setting error	Set according to the given parameter range

6.5 Warning

When the warning occurs, the inverter can continue to operate. The following table explains the cause of the failure and the corresponding measures.

Note: All warnings can be automatically eliminated if they do not meet the detection conditions.

Code	Name	Reason	Countermeasures
A.LU1	Shutdown undervoltage warning	Input supply voltage is too low	Increase input supply voltage
		Input power loss occurs	Confirm that the main circuit wiring is normal
		The input terminal of the input power supply is loose	Tighten the main circuit terminal block
		Inverter main circuit capacitor aging	Seeking technical support
Note: A.LU1 is normal during power failure due to the long discharge time of the capacitor voltage when the inverter is powered off.			
Code	Name	Reason	Countermeasures
A.OU	Stop over voltage warning	Power supply voltage is too high	Reduce the supply voltage to the specified range
		Inverter output or motor short to ground	Check main circuit wiring to eliminate short circuit
		Surge voltage mixed in the input voltage	Adding reactor on the input side
Note: This warning is detected when the bus voltage exceeds the overvoltage point. The overvoltage point is 820V for three-phase input and 400V for single-phase input.			
Code	Name	Reason	Countermeasures
A.ILF	Input phase loss warning	The main circuit terminal of the inverter is loose.	Tighten the screw and restart it.
		Input voltage fluctuation is too large	Improve the power supply to meet the rated voltage of the inverter If there is no problem with the main circuit power supply, check if there is a problem with the electromagnetic contactor on the main circuit side.
		Three-phase voltage imbalance	Check if there is a problem with the input voltage and improve the power imbalance.
Note: The F10.20 [Input, Output Phase Loss Protection Selection] ten digits select whether to enable the input phase loss warning detection function.			
Code	Name	Reason	Countermeasures
A.PID	PID feedback disconnection warning	PID disconnection detection related parameters are set incorrectly	Adjust F13.27 [Wire break detection upper limit], F13.28 [Wire break detection lower limit], and F13.26 [Wire break detection time]
		Improper wiring of PID feedback	Confirm that the PID feedback wiring is normal.
		Sensor for PID feedback fails	Check if the sensor is abnormal
		The PID feedback loop of the inverter control board is abnormal.	Seek technical support from manufacturers
Note: The PID feedback input is not within the range set by F13.27 [Disconnection Detection Upper Limit] and F13.28 [Disconnection Detection Lower			

Limit], and is reported after exceeding the setting value of F13.26 [Disconnection Detection Time]. The fault. The motor action can be detected when the fault is detected by F13.25 [PID feedback disconnection processing].			
Code	Name	Reason	Countermeasures
A.EEP	EEPROM read and write warning	Read and write parameters to receive interference during EEPROM operation	Re-read and write parameters after checking and eliminating interference sources
Code	Name	Reason	Countermeasures
A.DEF	Speed deviation too large warning	Excessive load	Reduce the load
		Adding and decelerating time is too short	Increase F01.22, F01.23 [addition and deceleration time]
		Improper setting of speed deviation detection parameters	Adjust F10.41 [speed deviation detection threshold] and F10.42 [speed deviation detection time]
		The motor electromagnetic brake is in the brake state	Open the brake
Note: The percentage of the output motor speed relative to F01.10 [maximum frequency] is greater than F10.41 [speed deviation detection threshold], and the fault is reported after F10.42 [speed deviation detection time]. This fault detection can be enabled by F10.40 [Speed deviation excessive protection action] and the motor operation mode when the fault is detected can be set.			
Code	Name	Reason	Countermeasures
A.SPD	Speed warning	Improper setting of encoder line number or pole number	Adjust F02.33 [ABZ encoder line number] or F02.34 [rotation pole number]
		Improper setting of parameters related to rapid detection	Adjust F10.44 [Flying Detection Threshold] and F10.45 [Fast Detection Time]
Note: The percentage of the output motor speed relative to F01.10 [maximum frequency] is greater than F10.44 [flying detection threshold], and the fault is reported after F10.45 [flying detection time]. This fault detection can be enabled by F10.43 [Fast protection action] and the motor operation mode when the fault is detected can be set.			
Code	Name	Reason	Countermeasures
A.GPS1	GPS lock	Inverter usage time reaches set time	Seek technical support from manufacturers
Note: GPS function needs to be equipped with GPRS expansion card.			
Code	Name	Reason	Countermeasures
A.GPS 2	GPS disconnection	Communication cable failure, such as short circuit, disconnection, etc.	Check if the communication connection is normal
		Communication data is abnormal due to interference	Check whether the grounding wire of the whole machine is normal. Change the communication cable with shield
Note: GPS function needs to be equipped with GPRS expansion card.			
Code	Name	Reason	Countermeasures
A.CE	Modbus communication warning	Communication cable failure, such as short circuit, disconnection, etc.	Check if the communication connection is normal
		Communication data is abnormal due to interference	Check whether the grounding wire of the whole machine is normal. Change the communication cable with shield
Note: This error is reported after the communication data is incorrect and exceeds the time set by F12.06 [Modbus Communication Timeout]. The motor action can be detected when this fault is detected by F12.07 [Communication Disconnection Processing].			
Code	Name	Reason	Countermeasures
A.BUS1	Expansion card A disconnected	There is a strong interference source that causes problems with data transmission.	Check the grounding of the whole machine to eliminate the interference source
		Expansion card A is not wired correctly, or disconnection occurs	Check if there is a problem with the expansion card A wiring.
Note: The motor action can be detected when the fault is detected by the F12.50 [Extension Card Communication Disconnection Processing] unit setting.			
Code	Name	Reason	Countermeasures
A.BUS2	Expansion card B is broken	There is a strong interference source that causes problems with data transmission.	Check the grounding of the whole machine to eliminate the interference source
		Expansion card B wiring is incorrect, or disconnection occurs	Check if there is a problem with the expansion card B wiring.
Note: The motor action can be detected when the fault is detected by the F12.50 [Extension Card Communication Disconnection Processing] ten-digit setting.			
Code	Name	Reason	Countermeasures
A.BUS3	CAN expansion card failure	There is a strong interference source that causes problems with data transmission.	Check the grounding of the whole machine to eliminate the interference source
		CAN expansion card wiring is incorrect, or disconnection occurs	Check if there is a problem with the CAN expansion card wiring
Note: The motor action can be detected when the fault is detected by the F12.50 [Extension Card Communication Disconnection Processing] Hundreds setting.			
Code	Name	Reason	Countermeasures
A.OH1	Module overheat warning	Ambient temperature is too high	Reduce the ambient temperature of the inverter
		Excessive load	Reduce the load
		Fan failure	Check whether the fan is running normally. If the fan is abnormal, you need to replace the fan and then power on.
Note: When the module temperature exceeds F10.25 [inverter overheat warning detection level], the warning is reported. If the module temperature continues to rise, the overheat fault E.OH1 will be triggered.			
Code	Name	Reason	Countermeasures

A.OH3	Motor overheat warning	Motor heat transfer is abnormal Excessive load	Improve motor cooling Reduce the load
<p>Note: This warning is reported when the motor temperature exceeds F10.27 [Motor overheat warning detection level]. Select which temperature sensor (PT1000/KTY84) to use by F10.26 [Motor overheat protection selection], and F10.26 [Motor overheat protection selection] ten setting to detect the motor action when this fault is detected. This function needs to be implemented with an IO expansion card.</p>			
Code	Name	Reason	Countermeasures
A.RUN1	Run command conflict	There is a shutdown signal externally, but the running command is valid at this time.	Restart after removing the external stop signal
Code	Name	Reason	Countermeasures
A.RUN2	Jog terminal start protection	After the start protection is turned on, the inverter will exit the abnormal click terminal and the effective warning prompt	First undo the jog terminal command and then re-given the jog run command
Code	Name	Reason	Countermeasures
A.RUN3	Terminal start protection	After the start protection is turned on, the terminal will be valid when the inverter exits abnormally.	First cancel the terminal command and re-given the terminal to run the command.
Code	Name	Reason	Countermeasures
A.PA2	External keyboard disconnection warning	There is a strong interference source that causes problems with data transmission.	Eliminate interference sources
		External keyboard wiring is incorrect or disconnected	Check if there is a problem with the external keyboard connection, re-plug the keyboard, still can not solve the problem of seeking external technical support for the manufacturer.
<p>Note: When the external keyboard disconnection warning appears, the re-plugging and unplugging keyboard still cannot be connected successfully. After the warning disappears, the running command is switched to the built-in keyboard.</p>			
Code	Name	Reason	Countermeasures
A.CP1	Compare output 1 warning	The monitoring value 1 set by F06.50[Comparator 1 monitor selection] exceeds F06.51 [Comparator 1 upper limit] and F06.52 [Comparator 1 upper limit].	Check the status of the monitor value 1 and eliminate the cause of the warning.
<p>Note: The motor operation mode when the fault is detected can be set by F06.54 [Comparator 1 Alarm Setting].</p>			
Code	Name	Reason	Countermeasures
A.CP2	Compare output 2 warning	The monitoring value 2 set by F06.55 [Comparator 2 monitor selection] exceeds F06.56 [Comparator 2 upper limit] and F06.57 [Comparator 2 upper limit].	Check the status of monitor value 2 and eliminate the cause of the warning.
<p>Note: The motor operation mode when the fault is detected can be set by F06.59 [Comparator 2 Alarm Setting].</p>			

6.6 Fault reset method

When the inverter has a fault and stops running, please follow the steps below to find out the cause and restart the inverter after taking appropriate countermeasures.

The inverter is powered off when a fault occurs

WARNING! Wear eye protection to protect your eyes before performing maintenance, repair, or replacement of the inverter.

WARNING! Do not restart the drive or run peripherals within 5 minutes when the fuse blows or the leakage circuit breaker trips. Please confirm the wiring and peripheral machine rating, find out the cause of the trip, if you can not find the reason, please consult the technical support department, otherwise it will lead to personal accident or damage to the inverter.

1. Use an external 24V power supply to power the control loop.
2. Confirm the fault code and the operating status of the inverter when the fault occurs via the fault monitoring parameter C01-xx.
3. Refer to the Troubleshooting section to troubleshoot the cause.

Note: 1. By C01-00 [this fault diagnosis information], you can confirm what is the fault and the power is cut off. You can check the status of the inverter (frequency and current) when this fault occurs through C01-01~C01-09. , voltage, etc.).

2. Through C01-10 [Last Fault Diagnosis Information], you can confirm what was the last time the power was cut off. You can check the status of the inverter (frequency, current, voltage) when the last fault occurred through C01-11~C01-19. Wait).

3. When the fault still remains after power-on, please rectify the fault and then reset the fault.

- Faults occurred but the inverter is not powered off

1. Confirm the fault code displayed on the keyboard.
2. Refer to the chapter on troubleshooting to troubleshoot the cause.
3. Perform a fault reset operation.

- Fault Reset

After the fault occurs, to restore the inverter to normal, you need to reset the fault after troubleshooting the cause. There are three fault reset methods, namely

1. Press the stop button on the keyboard in the event of a fault.
2. The multi-function input terminal function selects the fault reset and makes the terminal valid.
3. The inverter is powered back on.

6.7 Troubleshooting without prompting on the keyboard

When the fault code or error code is not displayed on the keyboard, but the operation of the inverter or motor is abnormal, please refer to the contents of this section and take appropriate measures.

- ◆ Parameters cannot be modified

Reason	Countermeasures
Modify the parameters that cannot be changed during operation when the inverter is running	Modify the parameter after stopping the inverter
Modify read-only parameters	Read-only parameters cannot be modified

◆ Input running command motor does not turn

Reason	Countermeasures
Run command given channel is not set properly	Check the F01.01 [Run Command Channel] setting to confirm the running command given source.
Improper setting of the frequency reference mode results in a given frequency of 0.	Check the F01.02 [frequency reference mode] setting to confirm that the frequency reference source is valid.
Emergency stop signal input	Release emergency stop signal
Improper terminal wiring when the terminal is used as a command channel	Confirm that the control circuit terminal wiring is correct View the status of the input terminals via C00-14 [Input Terminal Status]
The given frequency is too low	Check if C00-00 [reference frequency] is higher than the set value of F01.13 [lower limit frequency]

◆ The direction of motor rotation is opposite to the running command

Reason	Countermeasures
Improper wiring of motor cable	Confirm that the wiring of the inverter and motor are correct. Change the wiring of any two phases of the motor U, V, W
The motor's rotation direction is set incorrectly	Confirm that the wiring of the inverter and motor are correct. Modify F07.15 [select direction selection] unit position running direction inversion

◆ The motor only rotates in one direction

Reason	Countermeasures
Run direction prohibition function	Modify F07.15 [select direction selection] ten-bit running direction prohibition bit

◆ Abnormal motor heating

Reason	Countermeasures
Excessive load	Reduce the load Replace the larger power motor
Long-term operation at very low speed	Change the speed Replace with inverter-specific motor
Set to vector control mode but no motor self-learning	Motor self-learning Change the control mode to VF control if possible
The cooling fan of the motor is covered with excessive dust, causing the fan to stall or stop.	Cleaning the fan of the motor Improve the cleanliness of the environment

◆ Do not run according to the set acceleration/deceleration time

Reason	Countermeasures
Excessive load	Reduce the load Replace the larger power motor
Output current has reached current limit	Reduce the load Replace the larger power motor
Acceleration/deceleration time setting is too short	Increase F01.22, F01.23 [addition and deceleration time]
Improper setting of motor characteristic parameters	Check F4.00 [V/f curve selection] to confirm whether the V/f curve matching the motor characteristics is selected. Rotating self-learning
Self-learning without vector control	Motor self-learning Change the control mode to VF control if possible

◆ There is a significant deviation between motor speed and frequency command value

Reason	Countermeasures
Improper setting of frequency command gain and offset for analog input	Check if the relevant parameter value setting of the analog input terminal is appropriate. Terminal AI1: F05.40~F05.44 [terminal AI1 related parameters] Terminal AI2: F05.45~F05.49 [terminal AI2 related parameters]
Frequency given command source settings for overlay	Check F1.07 [Frequency Reference Source Selection] to confirm the frequency reference source

◆ Mechanical vibration or misalignment when the motor rotates

Reason	Countermeasures
Analog frequency command input from the outside	Check if the external signal line is affected by noise Try to isolate the main circuit wiring and the control loop wiring. The signal line of the control loop uses shielded wires or stranded wires. Increase the set value of the analog input filter time constant
The wiring distance between the inverter and the motor is too long	Minimize wiring length
Insufficient adjustment of PID parameters	Re-adjust F13.xx [PID Control Parameter Group]

◆ The output frequency does not reach the command frequency command value

Reason	Countermeasures
The set frequency command value is just within the skip frequency range.	Adjust F07.44, F07.46 [jump frequency 1, 2] and F07.45, F07.47 [jump frequency amplitude 1, 2] Note: When the skip frequency is valid, the output frequency does not

	change within the range of the skip frequency.
The given frequency exceeds the upper limit frequency setting	View F01.11 [Upper Frequency Source Selection] and confirm the upper limit frequency setting

7 Overhaul and Maintenance

This chapter describes the regular maintenance and maintenance methods during the use of the inverter, the replacement method of components such as cooling fans, and the instructions for keeping the inverter.

7.1 Safety Precautions

DANGER
<p>In order to prevent electric shock</p> <p>Do not perform wiring, inspection, or repair work while the power is on. Be sure to turn off the power to all machines before starting work. After the power is turned off, there is still residual voltage in the capacitor inside the inverter. It is necessary to confirm that the main circuit voltage has dropped to a safe level, and then perform related operations after 5 minutes. If it is neglected, it may cause personal accidents.</p> <p>Do not change the wiring, remove the wiring and optional cards, or replace the cooling fan while the drive is running.</p> <p>When the inverter is used to drive the motor, even if the inverter's power is turned off, the induced voltage will be generated at the motor terminals during the motor rotation. Wait until the motor line is disconnected or confirm that the motor is no longer rotating. There is a danger of electric shock due to incorrect operation.</p>
WARNING
<p>In order to prevent electric shock</p> <p>Do not operate with the inverter cover removed, otherwise there is a risk of electric shock.</p> <p>Be sure to operate the inverter in accordance with the instruction manual with the specified cover or cover installed.</p> <p>Be sure to ground the ground terminal on the motor side, otherwise it may cause electric shock due to contact between the person and the motor case. Non-electrical construction professionals should not perform wiring, installation, inspection, maintenance, component replacement or repair work, otherwise there is a risk of electric shock.</p> <p>Do not perform the operation of the inverter if you are wearing loose clothing or wearing accessories. If you take off metal objects such as watches and rings and wear loose clothes before work, there is a danger of electric shock.</p> <p>To prevent fire</p> <p>Fasten the terminal screws in accordance with the tightening torques in this book. If the tightening torque is insufficient, it may cause a fire due to overheating of the connecting part.</p> <p>If the tightening torque exceeds the specified tightening torque, it may cause malfunction of the device, damage to the terminal block or fire.</p> <p>Do not mistake the voltage of the main circuit power supply. Before powering on, please confirm whether the rated voltage of the inverter is consistent with the power supply voltage. If the main circuit power supply voltage is used incorrectly, there is a danger of fire.</p> <p>Do not allow inflammables to come into contact with the inverter or attach flammable materials to the inverter. Install the inverter on a flame retardant object such as metal. Otherwise there is a risk of fire.</p>
NOTE
<p>The heat sink of the inverter will generate high temperature and should not be touched.</p> <p>When operating the inverter, follow the steps specified in the Electrostatic Discharge Prevention (ESD) procedure. Otherwise, the internal circuit of the inverter may be damaged due to static electricity.</p> <p>Do not change the circuit of the inverter. Otherwise, the inverter will be damaged. Therefore, the repair will not be covered by the company. The company will not be responsible for it.</p> <p>After wiring the inverter and other machines, please confirm that all wiring is correct. If the wiring is incorrect, it may cause damage to the inverter.</p> <p>Please confirm the steering under the no-load of the motor. The wrong direction of rotation may cause personal injury or property damage.</p> <p>Do not run a machine that has been damaged. If the machine is obviously damaged or parts are missing, do not connect or operate it to avoid an accident.</p>

7.2 Overhaul

Electronic equipment consists of various electronic components, etc. If the relevant device is used for a longer period of time, it may cause characteristic changes or malfunction. In order to prevent such failures, preventive maintenance such as routine maintenance, regular maintenance, and parts replacement must be performed.

It is recommended that the machine be inspected every 3 to 4 months after installation. The inspection cycle of each machine varies according to working conditions, environmental conditions and usage conditions.

Shorten the inspection cycle if:

High temperature, high altitude environment;

Start and stop the environment frequently;

There is an environment where AC power and load have large fluctuations;

An environment with excessive vibration or shock;

An environment in which dust, metal dust, salt, sulfuric acid, and chlorine are present;

Bad preservation environment.

Please follow the maintenance items in this chapter to perform regular maintenance work.

◆ Daily inspection

In order to avoid the deterioration of the inverter function and product damage, please check and confirm the following daily items and track the effective records.

Note: Do not perform wiring, inspection or repair work while the power is on. Be sure to turn off the power to all machines before starting work. After the

power is turned off, there is still residual voltage in the capacitor inside the inverter. It is necessary to confirm that the main circuit voltage has dropped to a safe level. After 5 minutes, perform related operations to avoid personal accidents.

Check item	Check content	Processing method
Surroundings	Is the installation environment suitable?	Eliminate sources of pollution or improve the installation environment.
Power supply	Whether the power supply voltage meets the requirements and whether there is a lack of phase	According to the nameplate requirements, the corresponding power supply
Motor	Does the motor have abnormal vibration or abnormal sound?	Confirm the connection with the machine; Tighten the screws at the joint; Do lubrication treatment.
Load situation	Whether the output current of the inverter is higher than the rated value of the motor or the inverter for a certain period of time.	Confirm whether it is overloaded; Confirm that the motor parameters are set correctly.
cooling system	Whether the inverter and the motor have abnormal heat and discoloration.	Confirm whether it is overloaded; Tighten the screws; Check if the heat sink and motor of the inverter are dirty;
	The cooling fan is working properly.	Check if the fan is blocked or damaged.

◆ Periodic inspection

Under normal circumstances, a regular inspection is carried out in 3 to 4 months, but it is necessary to consider the shortening of the inspection cycle in combination with the use situation and working environment. The inspection is done with relevant confirmation and effective record.

Note: Do not perform wiring, inspection or repair work while the power is on. Be sure to turn off the power to all machines before starting work. After the power is turned off, there is still residual voltage in the capacitor inside the inverter. It is necessary to confirm that the main circuit voltage has dropped to a safe level. After 5 minutes, perform related operations to avoid personal accidents.

Check item	Check content	Processing method
overall	Environmental inspection, whether there is dirt or dust.	Confirm whether the relevant cabinet doors can be closed; Remove dirt or dust and improve the operating environment.
	Whether there is a part that changes color due to overheating aging; Is there any damage, deformation, or abnormal operation of the device?	Replace the relevant device; If it cannot be repaired, the entire inverter needs to be replaced.
wiring	Whether the wires and their joints are discolored, damaged, or cracked.	Repair or replace the wires.
Terminal block	Is the terminal worn, damaged or loose?	Tighten the screws; Replace damaged screws or terminals.
Mechanical devices such as electromagnetic contactors and relays	Whether the terminals are worn, damaged or in poor contact; Is the screw loose?	Tighten the screws; Replace the screws or terminals; If it cannot be replaced effectively, the inverter needs to be replaced.
Diode, IGBT (power transistor)	Whether it is contaminated with garbage and dust	Remove rubbish or dust to avoid touching parts.
Electrolytic capacitor	Whether there is liquid leakage, discoloration or cracking; Whether the safety valve has been arched out, whether there is a bulge, whether there is crack or leakage.	Replace the electrolytic capacitor; If there are damaged parts that cannot be repaired or replaced, replace the entire inverter
Brake option	Whether the insulation material is discolored due to overheating	When discoloration occurs, check if the wiring is defective.
A printed circuit board	Whether there is odor, discoloration or significant rust; Whether the plug is plugged in effectively; Whether it is dusty or oily.	Re-plug the plug; Replace the board; Do not use solvents when cleaning the board; Use a vacuum cleaner to remove rubbish or dust to avoid contact with parts; If there are damaged parts that cannot be repaired or replaced, replace the entire drive.
cooling fan	Whether there is abnormal vibration or abnormal sound; Whether there is damage or missing leaves.	Clean or replace the fan
heat sink	Whether it is contaminated with garbage and dust; Is it dirty?	Use a vacuum cleaner to remove rubbish or dust to avoid touching parts.
Vent	Ventilation inlet and outlet are blocked by foreign matter	Clear obstacles, dust
Keyboard display	Whether the screen display is correct; Is the operation button dirty?	If there is a problem with the screen or operation keys, please contact our agent or sales person in charge for cleaning.

7.3 Maintenance

All equipment and components have a service life. Proper maintenance can ensure an extended service life, but it cannot solve equipment and equipment

damage. Replace the device that meets or is about to reach the end of its life as required.

Note: Do not perform wiring, inspection or repair work while the power is on. Be sure to turn off the power to all machines before starting work. After the power is turned off, there is still residual voltage in the capacitor inside the inverter. It is necessary to confirm that the main circuit voltage has dropped to a safe level. After 5 minutes, perform related operations to avoid personal accidents.

Device name	Life cycle
Fan	2~3 years
Electrolytic capacitor	4~5 years
Printed circuit board	8~10 years

7.4 Replace the cooling fan

When replacing the cooling fan, please use the original fan and purchase the original fan. Please contact the agent who purchased the product or the sales department of the company. There are models with multiple cooling fans in the inverter. In order to maximize the service life of the product, all fans must be replaced at the same time.

The replacement of other devices is very strict with the maintenance technology and product familiarity, and must be strictly tested before being put into use. It is not recommended to replace other internal components. If you do need to replace it, please contact the agent where you purchased the product or the sales department of the company.

Note: Do not perform wiring, inspection or repair work while the power is on. Be sure to turn off the power to all machines before starting work. After the power is turned off, there is still residual voltage in the capacitor inside the inverter. It is necessary to confirm that the main circuit voltage has dropped to a safe level. After 5 minutes, perform related operations to avoid personal accidents.

7.5 Replace the inverter

Note: Do not perform wiring, inspection or repair work while the power is on. Be sure to turn off the power to all machines before starting work. After the power is turned off, there is still residual voltage in the capacitor inside the inverter. It is necessary to confirm that the main circuit voltage has dropped to a safe level. After 5 minutes, perform related operations to avoid personal accidents. Non-electrical construction professionals should not perform wiring, installation, maintenance, inspection, component replacement or repair work. Otherwise there is a danger of electric shock.

Note: When operating the inverter or when disassembling the printed circuit board, follow the steps specified in the electrostatic precautions (ESD). If the operation is incorrect, the internal circuit of the inverter may be damaged due to static electricity.

◆ Precautions when wiring the main circuit terminal block

- 1) Please use copper wire. Wires other than copper wire such as aluminum wire cannot be used.
- 2) Be careful not to allow foreign matter to enter the terminal block of the terminal block.
- 3) Please strip the wire end of the wire at the length of the bare wire at the end of the line as specified in this book.
- 4) Do not use bent or deformed wires. Cut off the end of the wire that has been bent and deformed by the connection before using it.
- 5) Do not perform welding when using stranded core wire.
- 6) When using stranded core wire, do not make wire whiskers appear at the joint. But do not over-twist the stranded core.
- 7) The wires should be inserted deep into the terminal block. After the wire end cladding is peeled off by a predetermined length, the cladding portion can enter the resin protection hole.
- 8) The tightening torque of each terminal is different. Please tighten the screws according to the specified tightening torque.
- 9) Use tools such as a torque wrench that matches the screw. Wiring the screw terminals requires a flat or hexagonal tool. Please refer to the recommended conditions in the book to select the tool.
- 10) When using an electric screwdriver, be careful to tighten it at a low speed of 300 to 400 r/min.
- 11) Wiring tools can also be purchased from the company. For details, please contact our agent or sales person in charge.
- 12) When replacing the old product with this product, the size of some of the wires in use may exceed the allowable range. For the use of the size of the wire, please contact our agent or sales person in charge.
- 13) When tightening the terminal screws, do not tilt more than 5°.
- 14) When using a hexagonal hole screw, be sure to insert a screwdriver into the depth of the hexagonal hole and then screw it.
- 15) When tightening the slotted screw, be sure to insert the screwdriver vertically into the slot of the screw. Do not remove the slot.
- 16) After wiring, gently pull the wire to confirm that it will fall off.
- 17) Please cut only the wiring cover at the terminals that need to be wired to block.
- 18) The screws of the terminal block should be retightened regularly according to the specified tightening torque.
- 19) If the wiring may be subjected to external force, use a clamp to enhance the strength of the wiring.

7.6 Custody essentials

Inverters, like other electronic products, use electrolytic capacitors that are prone to chemical reactions, as well as tiny electronic components. To ensure longevity and reliability during long-term storage, please observe the following precautions:

◆ Storage place

Ambient temperature and humidity: Store at a temperature of -30 ° C to +60 ° C, 95% RH or less, and do not condense and freeze, and direct sunlight.

During the transportation process, please package and keep the inverter safe from vibration or impact.

Dust, oil mist: Do not store in dusty or oily environments such as cement plants and textile mills.

Corrosive gases: Do not store in a chemical plant, refinery or sewage treatment plant where corrosive gases may be generated.

Salt erosion: Do not store in places with salt erosion, such as near the coast, especially in specific salt areas.

In addition, do not store it in other harsh environments, and store it in warehouses, offices, etc. that do not have the above factors.

◆ Regular power up

To prevent aging of the capacitor, please energize it for at least 30 minutes a year.

If it is not energized for more than two years, please use the adjustable power supply to slowly increase the voltage from 0V to the rated voltage of the inverter within 2 to 3 minutes, and then activate the main circuit electrolytic capacitor (no-load energization for more than 1 hour). During subsequent operation, please make normal wiring and confirm that there are no inverter abnormalities, excessive current, motor vibration, speed change, etc. during operation.

8 Scrap

8.1 Safety Precautions

DANGER
<p>In order to prevent electric shock</p> <p>Do not perform wiring, inspection, or repair work while the power is on. Be sure to turn off the power to all machines before starting work. After the power is turned off, there is still residual voltage in the capacitor inside the inverter. It is necessary to confirm that the main circuit voltage has dropped to a safe level, and then perform related operations after 5 minutes. If it is neglected, it may cause personal accidents.</p> <p>Do not change the wiring, remove the wiring and optional cards, or replace the cooling fan while the drive is running.</p> <p>When the inverter is used to drive the motor, even if the inverter's power is turned off, the induced voltage will be generated at the motor terminals during the motor rotation. Wait until the motor line is disconnected or confirm that the motor is no longer rotating. There is a danger of electric shock due to incorrect operation.</p>
WARNING
<p>In order to prevent electric shock</p> <p>Do not operate with the inverter cover removed, otherwise there is a risk of electric shock.</p> <p>Be sure to operate the inverter in accordance with the instruction manual with the specified cover or cover installed.</p> <p>Be sure to ground the ground terminal on the motor side, otherwise it may cause electric shock due to contact between the person and the motor case.</p> <p>Non-electrical construction professionals should not perform wiring, installation, inspection, maintenance, component replacement or repair work, otherwise there is a risk of electric shock.</p> <p>Do not perform the operation of the inverter if you are wearing loose clothing or wearing accessories. If you take off metal objects such as watches and rings and wear loose clothes before work, there is a danger of electric shock.</p> <p>To prevent fire</p> <p>Fasten the terminal screws in accordance with the tightening torques in this book. If the tightening torque is insufficient, it may cause a fire due to overheating of the connecting part.</p> <p>If the tightening torque exceeds the specified tightening torque, it may cause malfunction of the device, damage to the terminal block or fire.</p> <p>Do not mistake the voltage of the main circuit power supply. Before powering on, please confirm whether the rated voltage of the inverter is consistent with the power supply voltage. If the main circuit power supply voltage is used incorrectly, there is a danger of fire.</p> <p>Do not allow inflammables to come into contact with the inverter or attach flammable materials to the inverter. Install the inverter on a flame retardant object such as metal. Otherwise there is a risk of fire.</p>
NOTE
<p>The heat sink of the inverter will generate high temperature and should not be touched.</p> <p>When operating the inverter, follow the steps specified in the Electrostatic Discharge Prevention (ESD) procedure. Otherwise, the internal circuit of the inverter may be damaged due to static electricity.</p> <p>Do not change the circuit of the inverter. Otherwise, the inverter will be damaged. Therefore, the repair will not be covered by the company. The company will not be responsible for it.</p> <p>After wiring the inverter and other machines, please confirm that all wiring is correct. If the wiring is incorrect, it may cause damage to the inverter.</p> <p>Please confirm the steering under the no-load of the motor. The wrong direction of rotation may cause personal injury or property damage.</p> <p>Do not run a machine that has been damaged. If the machine is obviously damaged or parts are missing, do not connect or operate it to avoid an accident.</p>

8.2 Precautions related to scrapping

The scrapping of products and components is as follows. Please follow the relevant local laws and regulations and comply with the relevant laws or regulations of each country or region.



- 1) Inverter body
- 2) Packaging materials
- 3) Expansion card

Attention: In order to prevent injury, it will be properly scrapped after being discharged. So as not to cause a safety accident.

9 Peripheral Equipment and Options









9.1 Safety Precautions





User must obey to the following safety rules and related requirements while using the peripheral equipment and selecting components.

 <p>Danger</p>	<ul style="list-style-type: none"> ● No operation under power connected state. Otherwise, there is danger of electric shock. ● Before operation, please cut all related equipment power, ensure that the main circuit DC current has dropped to safe range. And please operate after 5 mins.
 <p>Warn</p>	<ul style="list-style-type: none"> ● No operation while cover/panel is dismantled. Otherwise, there is danger of electric shock. ● Do not dismantle the cover or PCB under power connected state. Otherwise, there is danger of electric shock. ● Only professional person can install, debug or maintain the peripheral equipment and options. Otherwise, there is danger. ● Do not wear loose clothes when install, debug, maintain. Rated protective tools and safeguard should be adopted. ● Do not change wire, dismantle jumping wire, optional card, or change cooling fan while the inverter is running. Otherwise, there is danger of electric shock. ● Tighten screw according to named torque. If main circuit wire connection is loose, there is danger of overheat fire. ● Earth of the peripheral equipment and options must be reliable to prevent human body injury.
<p>Important</p>	<ul style="list-style-type: none"> ● While operation, please follow the ESD regulations. Otherwise, the inverter maybe damaged. ● Do not cut the power supply while the inverter is outputting voltage. Otherwise, the inverter maybe damaged.

9.2 Peripheral Equipment

Normal peripheral equipment are showed as follows. To order the peripheral equipment, please consult our dealer or sales department.

Peripheral equipment		Functions
	Breaker	Protect power system and prevent malfunction impact other equipment working when short-circuit happens. And over-load protection.
	Leakage current breaker	Earth protection prevent electric shock(suggest to use the type which can prevent high-frequency leakage current)
	Electromagnetic contactor	Separate power and inverter indeed and realize basic relay control.
	AC input reactor	Improve power side factor and isolate the noise disturbance to the frequency inverter from the power side.
	DC reactor	Restrain ultra harmonics and improve power factor.
	Input side noise filter	Reduce frequency inverter disturbance to the power and reduce the power grid disturbance.
	Braking resistor	Passive energy consume unit of electric braking.
	Consumption braking unit	Electric braking control unit, controlling the braking resistance consume the regenerated electric power of the motor efficiently.
	Output side noise filter	Reduce the output side wire electromagnetic disturbance.

	Standby system	Standby system for inverter malfunction.
	Heat relay	Protect the motor while over load.
	0-phase reactor	Reduce electromagnetic disturbance of the frequency inverter (suitable for input/output side).
	Main loop surge absorption unit	Restrain surge voltage while main loop switch components act.
	Winding surge absorption unit	Restrain surge voltage when the AC contactor acts.

9.3 The use of peripheral equipment

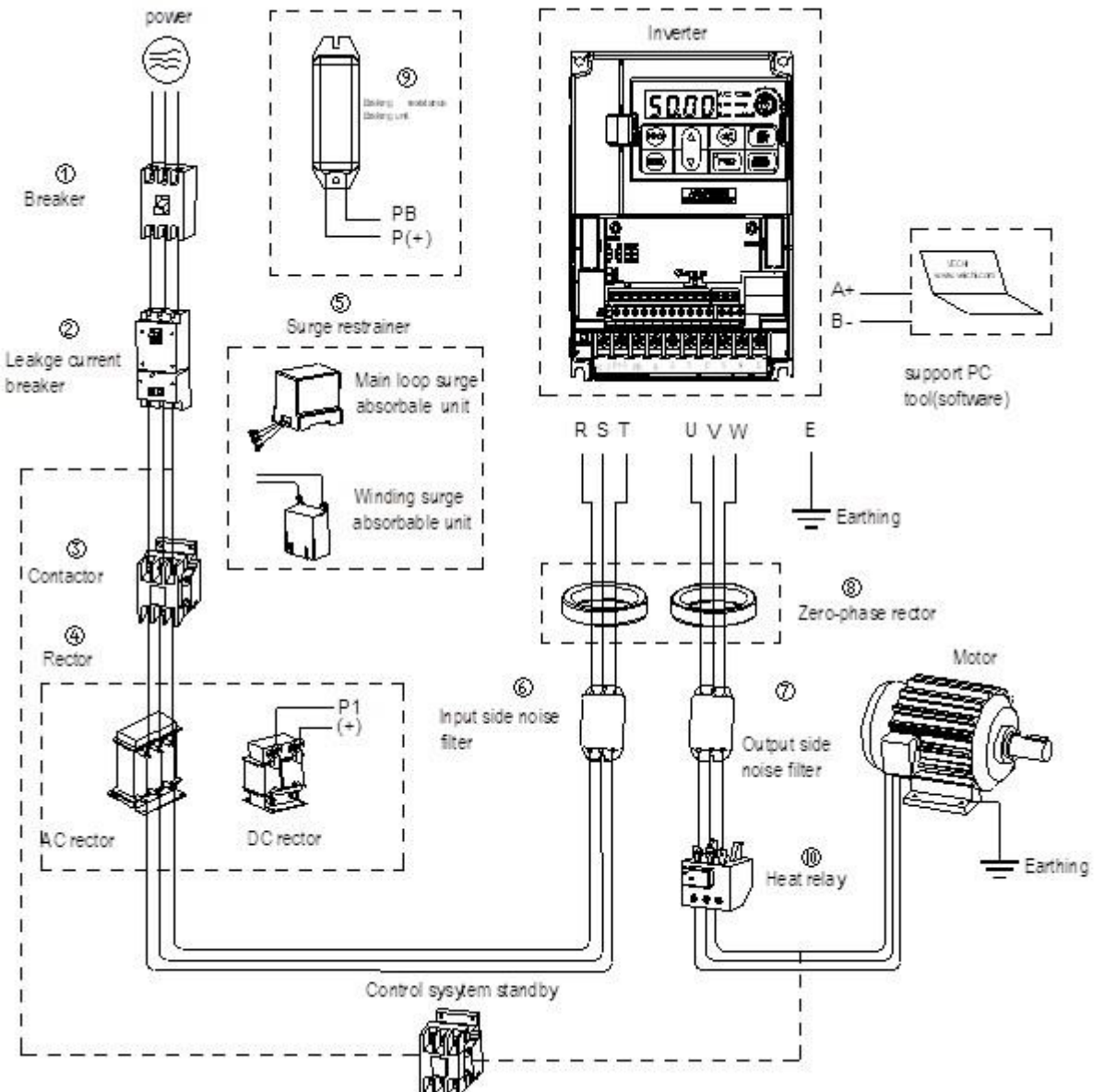

Chart 9-1: Peripheral equipment connection

Note :

▮ Wiring breaker

To ensure wiring safe, protect power system and prevent malfunction impact other equipment working when short-circuit happens, and protect while over-load, please do use wiring breaker between power supply and main loop power input terminals R,S,T.



While choosing the breaker, the capacitance should be about 1.5-2 times of the rated output current of the frequency inverter. Please compare the time characteristic of breaker and the characteristic of the inverter protection (150% of the rated output current, one minute). Make sure there will be no skip.



Before main loop wiring, make sure to cut the breaker and electromagnetic contactor. Otherwise, there is danger of electric shock. Leakage current breaker

The frequency inverter outputs peak voltage high-speed switch square wave, so there is high frequency leakage current. For earth protection to prevent electric shock and leakage current fire, please install leakage current breaker. Usually, one frequency inverter will bring 100mA leakage current (while the power cable length is 1m). If the length prolongs 1m, there will be 5mA more leakage current. So please use leakage current breaker special for high frequency leakage at the power input side of the frequency inverter. The factors which impact leakage current are as follows:

Capacitance of inverter;

Carrier frequency;

Motor cable type and wire length;

EMI/RFI filter.

To protect human body and inverter, please choose leakage current breaker which can use AC/DC power and can reply high frequency leakage current. There should be one leakage current breaker with more than 200mA sensitive current for every frequency inverter. If the frequency inverter outputs different wave, the high frequency leakage current will be higher, what will make the breaker malfunction. At this case, please take following treatments:

Improve the sensitive current of the leakage current breaker;

Reduce the carrier frequency of the inverter.

Electromagnetic contactor

Electromagnetic contactor is a peripheral equipment what is set to separate power and inverter connection. While inverter protective function is acting or carrying out emergency stop operation, the main loop power can be cut by peripheral equipment. Please do not connect the electromagnetic switch or electromagnetic contactor to output circuit. Otherwise, the inverter maybe damaged. While the power recovers after instant stop, if it needs to prevent the inverter to auto-restart, please install electromagnetic contactor for control at the input side.

AC input reactor and DC reactor

To restrain current sharp change and high hypo harmonic current, it needs to use AC input reactor and DC reactor. It can also improve power factor at the input side. In the following cases, AC input reactor or DC reactor must be used (use both will bring better effect).

Need to restrain ultra harmonics current and improve power side factor;

Need to switch input phase capacitance;

When frequency inverter is connected to large capacitance power transformer (600kVA above);

Silicon-controlled converters such as DC motor driver are connected to the same power system.

If user has higher requirement on other harmonic restraint, please connect the external DC reactor .Before connecting the external DC reactor, make sure to dismantle the short connector between the terminals P1 and (+).

▮ Surge restrainer

Surge restrainer is divided to winding surge restrainer and main loop surge restrainer according to the use position. Pls choose the right one which is suitable for the occasion. The aim of surge restrainer installation is restraining the surge voltage brought by switch components such as inductive load which is surrounding the frequency inverter (electromagnetic contactor, electromagnetic relay, electromagnetic valve, electromagnetic winding, electromagnetic detent). Do not connect the surge restrainer to the output side of the frequency inverter. Otherwise, the frequency inverter will be damaged.

▮ Input side noise filter

Rectifier bridge of the inverter is uncontrolled rectifier. And input current is discontinuous impulse current. So the harmonic current noise signal, what flows to power wire from the inverter inner, maybe bring bad impact on the surrounding machines (radio, phone, noncontact switch, sensor). This time, we suggest to instal input side noise filter to lighten the noise into the power wire. Besides, it can also reduce noise from the power wire into the frequency inverter.



:Please use the special noise filter for the frequency inverter and the connection wire between the filter and the inverter should be as short as possible.

Output side noise filter

The frequency inverter outputs square wave with high-speed peak value voltage switch. So there is high-speed dv/dt conver on the output cables that will produce a large number of radio disturbance and inductive signal. By installation noise filter at the output side, the impact can be relieved. Please do not install the into phase capacitance and the noise filter to the output circuit. Otherwise, there is danger of damage to the frequency inverter.

▮ Phase reactor

0-phase reactor is used for reducing the electromagnetic interference of the frequency inverter, which is suitable for the input side and output side. It equals to a three-phase common mode inductance. In actual use, according to the actual magnetic core size and cable specification, it is better to make sure 3-5 circles winding ratio to bring the best performance.

▮ Braking reactor or braking unit

Renewable electricity consumption unit, please see the sixth part of the chapter three "electric installation".

▣ Heat relay

Please install the heat relay at the output side of the frequency inverter. When the motor enters into overload state, it will cut the power source to protect the motor. While using one frequency inverter to drive one motor, it is unnecessary to install heat relay. The motor overload protection current [F10.16] of the frequency will work. While using one frequency inverter to drive multiple motors or the motor is drove directly by the power grid, please install heat relay between the inverter and the motor. While installing the heat relay, please design to cut the sequence control circuit of the MC at the main loop iuput side by the connection spot of the relay or design to input the heat relay action into the frequency inverter as the exterior malfunction. And please pay attention to the following tips to avoid heat relay malfunction and motor overheating at low speed.

Run at low speed

One frequency inverter run multiple motors

Motor cable is very long

Detect malfunction mistakenly for carrier frequency is too higher.

▣ Low speed and heat relay

In normal case, the heat relay is suitable for the universal motor. While using the frequency inverter to run the universal motor (standard motor), the motor current is 5-10% higher, comparing with the commercial power supply. Besides, at low speed, even in the motor rated current range, the cooling capability of the fan drove by the motor axis will reduce, which will bring motor overheat. So please set the motor overheat protection current [F10.16] in the frequency inverter to be valid.

▣ Motor cable is longer

While the motor cable is longer and the carrier frequency is higher, impacted by the leakage current, the heat relay maybe malfunction. To avoid it, please reduce the carrier frequency or set higher detection value of the heat relay. Before enhance the detection value, do confirm whether there is other cause for the motor overheat. Otherwise, there is danger.

10 Function Table

10.1 Safety Precautions

DANGER

Please pay attention to all the information about safety in this book.

If you do not follow the warnings, you may cause death or serious injury, so please pay attention. The company will not be responsible for any damage or equipment damage caused by your company or your company's customers who fail to comply with the contents of this book.

10.2 Reading Method of Parameter List

- ◆ Icons and terms that represent control modes

Icon	Content
V/F	Valid parameters in V/F control mode
SVC	Effective parameters under open loop vector control

- ◆ Icons and terms that represent control modes

Icon	Content
RUN	Parameters that can be modified during operation
STOP	Parameters that cannot be modified during operation
READ	This parameter can only be read and cannot be modified.

10.3 Functional Group

NOTE

Parameter [F 11.30] sets RS485/external keyboard to choose one. This parameter is not restored with [F00.03] parameter. Users are strongly advised to unlock the hardware connection of another channel when using one of them.

◆ Indicates the type of this product parameter

Parameter	Name
F00 group environment application	F00.0X Environment setting
	F00.1X Common parameter settings
F01 group basic settings	F01.0X Basic instruction
	F01.1X Frequency command
	F01.2X-F01.3X Acceleration time
	F01.4X PWM control
F02 group motor 1 parameters	F02.0X Basic motor parameters and self-learning options
	F02.1X Asynchronous motor advanced parameters
	F02.2X-F02.4X Reserved
	F02.5X Motor application parameters
F03 group vector control	F03.0X Speed loop
	F03.1X Current loop and torque limit
	F03.2X Torque optimization control
	F03.3X Flux optimization
	F03.4X-F03.5X Torque control
F04 group V/F control	F04.0X V/F control
	F04.1X Custom V/F curve
	F04.2X Reserved
	F04.3X V/F energy saving control
F05 group input terminal	F05.0X Digital input terminal
	F05.1X X1-X4 detection delay
	F05.2X Digital input terminal action selection
	F05.3X PUL terminal
	F05.4X Analog type processing
	F05.5X Analog linear processing
	F05.6X AI curve 1 processing
	F05.7X AI curve 2 processing
F05.8X AI as a digital input terminal	
F06 group output terminal	F06.0X AO output
	F06.1X Reserved
	F06.2X- F06.3X Digital, register output
	F06.4X Frequency detection
	F06.5X Monitor parameter comparator output
	F06.6X Virtual input and output terminal
F07 group operation control	F07.0X Start control
	F07.1X Shutdown control
	F07.2X DC braking and speed tracking
	F07.3X Jog
	F07.4X Start, stop frequency maintenance and frequency hopping
F08 group auxiliary control 1	F08.0X Counting and timing
	F08.1X Reserved
	F08.2X Reserved
	F08.3X Swing frequency control
	F08.4X Droop control
F09 group auxiliary control 2	F09.0X Reserved
F10 group protection parameters	F10.0X Current protection
	F10.1X Voltage protection
	F10.2X Auxiliary protection
	F10.3X Load protection
	F10.4X Stall protection
	F10.5X Failure recovery protection
F11 group keyboard parameters	F11.0X Key operation
	F11.1X Status interface loop monitoring
	F11.2X Monitoring parameter control
	F11.3X Keyboard special features
F12 group communication parameters	F12.0X MODBUS slave parameters
	F12.1X MODBUS host parameters
F13 group process PID control	F13.00-F13.06 PID given and feedback
	F13.07-F13.24 PID adjustment
	F13.25-F13.28 PID feedback disconnection judgment
	F13.29-F13.33 Sleep function
F14 group multi-speed and simple PLC	F14.00-F14.14 Multi-speed frequency given
	F14.15 PLC operation mode selection

	F14.16-F14.30	PLC running time selection
	F14.31-F14.45	PLC direction and acceleration and deceleration time selection
Monitoring parameter group	C00.XX	Basic monitoring
	C01.XX	Fault monitoring
	C02.XX	Application
	C03.XX	Maintenance monitoring
Communication variable group	MODBUS basic communication group	Communication address 0x3000~0x301F, 0x2000~0x201F
	Input and output interface group	Communication address 0x3400~0x341F
	Extended fault and power down parameters	Communication address 0x3600~0x361F

10.4 Group F00: Environmental Applications

F00.0x group: Environment setting

Parameter (address) djustable attribute	Name	Content	Factory default (setting range)
F00.00 (0x0000) RUN	Parameter access level	V/F SVC Set the parameter access level based on the case of restricted parameter access. 0: Standard parameter 1: Common parameters (F00.00, Pxx.yy) 2: Monitoring parameters (F00.00, Cxx.yy) 3: The parameter has been changed (F00.00, Hxx.yy)	0 (0 ~ 3)
F00.03 (0x0003) STOP	Initialization	V/F SVC Set the inverter initialization method. 0: Not initialized 11: Select the set value according to the purpose to carry out the parameters (excluding the motor parameters) 22: All parameters are initialized 33: Clear the fault record	0 (0 ~ 33)
F00.04 (0x0004) STOP	Keyboard parameter copy	V/F SVC 0: No function 11: Upload parameters to the keyboard 22: Download parameters to the inverter	0 (0 ~ 9999)
F00.05 (0x0005) STOP	User password	V/F SVC Used to set the user password.	0 (0 ~ 65355)
F00.06 (0x0006) RUN	LCD keyboard language selection	V/F SVC Select the language displayed on the LCD operator. 0: Chinese 1: English	0 (0 ~ 1)
F00.07 (0x0007) RUN	Free parameter 1	V/F SVC When using multiple machines, it is used as the machine number. When using multiple machines, the mode number is used for each purpose.	0 (0 ~ 65535)
F00.08 (0x0008) RUN	Free parameter 2	V/F SVC When using multiple machines, it is used as the machine number. When using multiple machines, the mode number is used for each purpose.	0 (0 ~ 65535)

F00.1x group: Common parameter settings

Parameter (address) djustable attribute	Name	Content	Factory default (setting range)
---	------	---------	---------------------------------

F00.10~F00.39 (0x0010 ~ 0x0027) RUN	Common parameter address setting	V/F SVC LED "0" and "00" digit: yy setting in function parameter number Fxx.yy 00~99 LED "000" and "0000": Function parameter number Fxx.yy in xx setting 00~31	0102 (0000 ~ 2363)
--	-------------------------------------	---	-----------------------

10.5 Group F01: Basic Settings

F01.0x group: Basic instructions

Parameter (address) djustable attribute	Name	Content	Factory default (setting range)
F01.00 (0x0100) STOP	Motor 1 control mode	V/F SVC The way the motor is controlled. 0: AM-VF; VF control 1: AM-SVC; Open loop vector control, current closed loop control	0 (0 ~ 1)
F01.01 (0x0101) RUN	Run command channel	V/F SVC Used to select the channel that the drive accepts the run and stop commands and the direction of travel. 0: Keyboard control (external keyboard priority) 1: Terminal control 2: RS485 communication control	0 (0 ~ 3)
F01.02 (0x0102) RUN	Frequency reference source channel A	V/F SVC The frequency converter sets the given source of the frequency. 0: Keyboard digital given frequency 1: Keyboard analog potentiometer given 2: Current/voltage analog AI given 3: Reserved 4: Reserved 5: Terminal pulse PUL given 6: RS485 communication given 7: Terminal UP/DW control 8: PID control given 9: Program Control (PLC) given 10: Option card 11: Multi-speed speed given	0 (0 ~ 11)
F01.03 (0x0103) STOP	Frequency reference source channel A gain	V/F SVC The frequency gives the gain of source channel A.	100.0 (0.0 ~ 500.0%)
F01.04 (0x0104) RUN	Frequency reference source channel B	V/F SVC The frequency converter sets the given source of the frequency. Same as [F01.02]	0 (0 ~ 11)
F01.05 (0x0105) STOP	Frequency reference source channel B gain	V/F SVC The frequency gives the gain of source channel B.	100.0 (0.0 ~ 500.0%)
F01.06 (0x0106) RUN	Frequency channel B reference source	V/F SVC The reference source of frequency given channel B is selected by this parameter. 0: Reference source with maximum output frequency 1: Use A to set the frequency as the reference source	0 (0 ~ 1)

F01.07 (0x0107) RUN	Frequency reference source selection	V/F SVC It is used to select the combination mode of the inverter setting frequency channel A and channel B. 0: Channel A 1: Channel B 2: Channel A + Channel B. 3: Channel A-channel B 4: Channel A, channel B both maximum 5: Channel A, channel B, both minimum	0 (0 ~ 5)
F01.08 (0x0108) RUN	Run command bundled given frequency	V/F SVC When this parameter is valid, it is used to set the channel source frequency channel for each running command channel. LED "0" digit: Keyboard command instruction bundle LED "00" digit: Terminal command command bundle LED "000" digit: Bundle of communication command instructions LED "0000" digit: Optional Card Command Command Bundle 0: No binding 1: Keyboard digital given frequency 2: Keyboard analog potentiometer given 3: Current/voltage analog AI given 4: Reserved 5: Reserved 6: Terminal pulse PUL given 7: Communication given 8: Terminal UP/DW control 9: PID control given A: Program control (PLC) given B: Option card C: Multi-speed speed given D: Reserved	0000 (0000 DDDD) ~
F01.09 (0x0109) RUN	Keyboard digital given frequency	V/F SVC Used to set and modify the keyboard digital setting frequency.	50Hz (0.00 to upper limit frequency setting)

F01.1x group: Frequency command

Parameter (address) djustable attribute	Name	Content	Factory default (setting range)
F01.10 (0x010A) STOP	Maximum frequency	V/F SVC The maximum frequency that the frequency converter can set.	50.00Hz (upper limit frequency~600.00Hz)
F01.11 (0x010B) RUN	Upper frequency source selection	V/F SVC Select a given source for the upper limit frequency of the drive. 0: Upper limit frequency number given 1: Keyboard analog potentiometer given 2: Current/voltage analog AI given 3: Reserved 4: Reserved 5: Terminal pulse PUL given	0 (0~7)
F01.12 (0x010C) RUN	Upper limit frequency digital setting	V/F SVC The upper line frequency is given when F01.11 is set to 0.	0.00Hz (0.00~upper limit frequency digital setting)
F01.13 (0x010D) RUN	Lower limit frequency	V/F SVC Given a lower frequency limit, the given frequency is limited.	0.00Hz (0.00~upper limit frequency digital setting)
F01.14 (0x010D) STOP	Resolution of frequency reference	V/F SVC 0:0.00Hz 1:r/min; 2:0.1Hz(compatible with high frequency reference given like 3000Hz,developing)	0.00Hz (developing)

F01.2x-F01.3x group: Acceleration and deceleration time

Parameter (address) djustable attribute	Name	Content	Factory default (setting range)
F01.20 (0x0114) STOP	Acceleration/deceleration time reference frequency	V/F SVC Set the reference frequency to calculate the acceleration/deceleration time. 0: Maximum frequency 1: Fixed frequency 50Hz 2: Set the frequency	0 (0 ~ 2)
F01.21 (0x0115) STOP	Acceleration time unit	V/F SVC The unit of acceleration time setting. 0: 1s 1: 0.1s 2: 0.01s	2 (0 ~ 2)
F01.22 (0x0116) RUN	Acceleration time 1	V/F SVC The time required for the output frequency to accelerate from 0.00 Hz to the time reference frequency. 1 to 65000 s (F01.21 = 0) 0.1 to 6500.0 s (F01.21 = 1) 0.01 to 650.00 s (F01.21 = 2)	Model setting (0.01 ~ 650.00s)
F01.23 (0x0117) RUN	Deceleration time 1	V/F SVC The time it takes for the output frequency to decelerate from the time reference frequency to 0.00 Hz.	Model setting (0.01~650.00 s)
F01.24 (0x0118) RUN	Acceleration time 2	V/F SVC The time required for the output frequency to accelerate from 0.00 Hz to the time reference frequency.	Model setting (0.01~650.00 s)
F01.25 (0x0119) RUN	Deceleration time 2	V/F SVC The time it takes for the output frequency to decelerate from the time reference frequency to 0.00 Hz.	Model setting (0.01~650.00 s)
F01.26 (0x011A) RUN	Acceleration time 3	V/F SVC The time required for the output frequency to accelerate from 0.00 Hz to the time reference frequency.	Model setting (0.01~650.00 s)
F01.27 (0x011B) RUN	Deceleration time 3	V/F SVC The time it takes for the output frequency to decelerate from the time reference frequency to 0.00 Hz.	Model setting (0.01~650.00 s)
F01.28 (0x011C) RUN	Acceleration time 4	V/F SVC The time required for the output frequency to accelerate from 0.00 Hz to the time reference frequency.	Model setting (0.01~650.00 s)
F01.29 (0x011D) RUN	Deceleration time 4	V/F SVC The time it takes for the output frequency to decelerate from the time reference frequency to 0.00 Hz.	Model setting (0.01~650.00 s)
F01.30 (0x011E) STOP	S curve acceleration and deceleration selection	V/F SVC S curve acceleration and deceleration selection is valid 0: Invalid 1: Valid	1 (0~1)
F01.31 (0x011F) STOP	Acceleration start S curve time	V/F SVC Set the acceleration start S curve time.	0.20s (0.00~10.00)
F01.32 (0x0120) STOP	Accelerated end S curve time	V/F SVC Set the acceleration end S curve time.	0.20s (0.00~10.00)
F01.33 (0x0121) STOP	Deceleration start S curve time	V/F SVC Set the deceleration start S curve time.	0.20s (0.00~10.00)
F01.34 (0x0122) STOP	Deceleration end S curve time	V/F SVC Set the deceleration end S curve time.	0.20s (0.00~10.00)
F01.35 (0x0123) RUN	Acceleration time 1 and acceleration time 2 switching frequency	V/F SVC Set the acceleration time 1 and acceleration time 2 to switch the frequency.	0.00Hz (0.00~Maximum frequency)

F01.4x group: PWM control

Parameter (address) djustable attribute	Name	Content	Factory default (setting range)
F01.40 (0x0128) RUN	Carrier frequency	V/F SVC Used to set the switching frequency of the inverter IGBT.	4.0 kHz (1.0~16.0kHz)
F01.41 (0x0129) RUN	PWM control mode	V/F SVC LED "0" digit: Carrier and temperature 0: Independent of temperature 1: Related to temperature LED "00" digit: Carrier and output frequency correlation 0: Independent of the output frequency 1: Related to the output frequency LED "000" digit: Random PWM Enable 0: Forbidden 1: Enable LED "0000" digit: PWM modulation method	1111 (0000 ~ 1111)
F01.42 (0x012A) RUN	Reserved		
F01.43 (0x012B) RUN	Dead zone compensation gain	V/F SVC Dead zone compensation gain	306 (0 ~ 512)

10.6 Group F02: Motor 1 Parameters

F02.0x group: Basic motor parameters and self-learning options

Parameter (address) djustable attribute	Name	Content	Factory default (setting range)
F02.00 (0x0200) READ	Motor type	V/F SVC Set the type of motor 0: Asynchronous motor (AM) 1: Reserved	0 (0 ~ 1)
F02.01 (0x0201) STOP	Pole number	V/F SVC Set the number of motor stages.	4 (2 ~ 98)
F02.02 (0x0202) STOP	Motor rated power	V/F SVC Set the rated power of the motor.	Model setting (0.1~1000.0kW)
F02.03 (0x0203) STOP	Motor rated frequency	V/F SVC Set the rated frequency of the motor.	Model setting (0.01~Maximum frequency)
F02.04 (0x0204) STOP	Motor rated speed	V/F SVC Set the rated speed of the motor.	Model setting (0~6500rpm)
F02.05 (0x0205) STOP	Motor rated voltage	V/F SVC Set the rated voltage of the motor.	Model setting (0~1500V)
F02.06 (0x0206) STOP	Motor rated current	V/F SVC Set the rated current of the motor.	Model setting (0.1~3000.0A)
F02.07 (0x0207) STOP	Motor parameter auto-tuning selection	V/F SVC After the parameter auto-tuning is completed, the set value of [F02.07] will be automatically set to "0". 0: No operation 1: Rotary self-tuning 2: Static self-tuning	0 (0 ~ 3)

F02.1x group: asynchronous motor advanced parameters

Parameter (address) djustable attribute	Name	Content	Factory default (setting range)
---	------	---------	---------------------------------

F02.10 (0x020A) STOP	Asynchronous motor no-load current	V/F SVC Set the size of the no-load current of the asynchronous motor.	Model setting (0.1~3000.0A)
F02.11 (0x020B) STOP	Asynchronous motor stator resistance	V/F SVC Set the size of the asynchronous motor stator resistance.	Model setting (0.01m Ω ~ 60000m Ω)
F02.12 (0x020C) STOP	Asynchronous motor rotor resistance	V/F SVC Set the size of the asynchronous motor rotor resistance.	Model setting (0.01m Ω ~60000m Ω)
F02.13 (0x020D) STOP	Asynchronous motor stator leakage inductance	V/F SVC Set the stator leakage inductance of the asynchronous motor.	Model setting (0.01mH~ 65535mH)
F02.14 (0x020E) STOP	Asynchronous motor stator inductance	V/F SVC Set the stator inductance of the asynchronous motor.	Model setting (0.01mH~ 65535mH)
F02.15 (0x020F) READ	Stator resistance standard value	V/F SVC Set the stator resistance value.	Model setting (0.01~50.00%)
F02.16 (0x0210) READ	Rotor resistance standard value	V/F SVC Set the rotor resistance value.	Model setting (0.01~50.00%)
F02.17 (0x0211) READ	Stator leakage inductance	V/F SVC Set the stator leakage inductance value.	Model setting (0.01~50.00%)
F02.18 (0x0212) READ	Stator inductance value	V/F SVC Set the stator inductance value.	Model setting (0.1~999.0%)
F02.19 (0x0213) STOP	F02.11~F02.14 decimal point selection	V/F SVC Set the decimal point of the four parameters F02.11~F02.14.	0x0000 (0x0000 ~ 0x2222)

F02.2x-F02.4x group: Reserved

F02.5x group: Motor application parameters

Parameter (address) djustable attribute	Name	Content	Factory default (setting range)	Notes
F02.50 (0x0232) STOP	Motor online learning function selection	V/F SVC 0: Invalid 1: Power-on self-learning 2: Run the initial segment self-learning 3: Self-learning in operation	0 (0 ~ 3)	S/T2 models do not support motor online learning

10.7 Group F03: Vector Control

F03.0x group: Speed loop

Parameter (address) djustable attribute	Name	Content	Factory default (setting range)
F03.00 (0x0300) RUN	ASR speed rigidity level	SVC The rigidity level is set, and the higher the level, the better the speed rigidity.	10 (1 ~ 25)
F03.01 (0x0301) RUN	ASR speed rigid mode	SVC The rigidity level is set, and the higher the level, the better the speed rigidity.	0x0000 (0x0000~0x1111)
F03.02 (0x0302) RUN	ASR (speed loop) proportional gain 1	SVC Set the ASR (speed loop) proportional gain 1.	10 (0.01 ~ 100.00)
F03.03 (0x0303) RUN	ASR (speed loop) integration time 1	SVC Set the ASR (speed loop) integration time 1.	0.100s (0.000~6.000s)
F03.04 (0x0304) RUN	ASR filtering time 1	SVC Set the ASR filter time 1.	0.0ms (0.0~100.0ms)

F03.05 (0x0305) RUN	ASR switching frequency 1	SVC Set the ASR switching frequency to 1.	0.00Hz (0.00~Maximum frequency)
F03.06 (0x0306) RUN	ASR (speed loop) proportional gain 2	SVC Set the ASR (speed loop) proportional gain 2.	10 (0.01 ~ 100.00)
F03.07 (0x0307) RUN	ASR (speed loop) integration time 2	SVC Set the ASR (speed loop) integration time 2.	0.100s (0.000~6.000s)
F03.08 (0x0308) RUN	ASR filtering time 2	SVC Set the ASR filter time 2.	0.0ms (0.0~100.0ms)
F03.09 (0x0309) RUN	ASR switching frequency 2	SVC Set the ASR switching frequency 2.	0.00Hz (0.00~Max frequency)

F03.1x group: Current loop and torque limit

Parameter (address) djustable attribute	Name	Content	Factory default (setting range)
F03.10 (0x030A) RUN	Current loop D-axis proportional gain	SVC Set the current loop D-axis proportional gain.	1.00 (0.001 ~ 4.000)
F03.11 (0x030B) RUN	Current loop D-axis integral gain	SVC Set the current loop D-axis integral gain.	1.00 (0.001 ~ 4.000)
F03.12 (0x030C) RUN	Current loop Q-axis proportional gain	SVC Set the current loop Q-axis proportional gain.	1.00 (0.001 ~ 4.000)
F03.13 (0x030D) RUN	Current loop Q-axis integral gain	SVC Set the current loop Q-axis integral gain.	1.00 (0.001 ~ 4.000)
F03.15 (0x030E) RUN	Electric state torque limit	SVC Set the motor state torque limit.	180.0% (0.0~400.0%)
F03.16 (0x030F) RUN	Power generation torque limit	SVC Set the generator state torque limit.	180.0% (0.0~400.0%)
F03.17 (0x0312) RUN	Regenerative torque limit at low speed	SVC Set the regenerative torque limit value at low speed.	50.0% (0.0~400.0%)
F03.18 (0x0313) RUN	Torque limit action frequency amplitude at low speed	SVC Set the torque limit action frequency range at low speed.	6.00s (0.00~30.00s)

F03.2x group: Torque optimization control

Parameter (address) djustable attribute	Name	Content	Factory default (setting range)
F03.23 (0x0314) RUN	Asynchronous motor slip compensation	SVC Set the asynchronous motor slip compensation.	100.0% (0.0 ~ 250.0%)
F03.24 (0x0315) RUN	Starting torque initial value	SVC Set the initial value of the starting torque.	0.0% (0.0 ~ 250.0%)

F03.3x group: Flux optimization

Parameter (address) djustable attribute	Name	Content	Factory default (setting range)
F03.30 (0x031E) RUN	Weak magnetic feedforward coefficient	SVC Set the weak magnetic feed forward coefficient.	10.0% (0.0 ~ 200.0%)

F03.31 (0x031F) RUN	Weak magnetic control gain	SVC Set the field weakening control gain.	10.0% (0.0 ~ 500.0%)
F03.32 (0x0320) RUN	Weak magnetic current upper limit	SVC Set the upper limit of the field weakening current.	60.0% (0.0 ~ 250.0%)
F03.33 (0x0321) RUN	Weak magnetic voltage coefficient	SVC Set the weak magnetic voltage coefficient.	97.0% (0.0 ~ 120.0%)
F03.34 (0x0322) RUN	Output power limit	SVC Set the output power limit.	250.0% (0.0 ~ 400.0%)
F03.35 (0x0323) RUN	Overexcitation braking gain	SVC Set the overexcitation braking gain.	100.0% (0.0 ~ 500.0%)
F03.36 (0x0324) RUN	Overexcitation braking limit	SVC Set the overexcitation brake limiter.	10.0% (0.0 ~ 250.0%)
F03.37 (0x0325) RUN	Energy efficient operation	SVC 0: off 1: on	0 (0 ~ 1)
F03.38 (0x0326) RUN	Energy-saving operation excitation lower limit	SVC Set the lower limit of excitation for energy saving operation.	50.0% (0.0 ~ 80.0%)
F03.39 (0x0327) RUN	Energy-saving operating filter coefficient	SVC Set the energy saving operation filter coefficient.	0.010s (0.000 ~ 6.000s)

F03.4x-F03.5x group: Torque Control

Parameter (address) djustable attribute	Name	Content	Factory default (setting range)
F03.40 (0x0328) RUN	Torque control selection	SVC 0: Speed control mode limit torque 1: Torque control mode speed limit	0 (0 ~ 1)
F03.41 (0x0329) RUN	Torque command given	SVC LED "0" digit: Channel A: 0: Torque keyboard digital reference 1: Integrated keyboard potentiometer given 2: AI 3: Reserved 4: Reserved 5: PUL 6: RS485 communication given LED "00" digit: Channel B: Same channel A LED "000" digit: Combination method: 0: A 1: B 2: A+B	0000 (0000 ~ 0566)
F03.42 (0x032A) RUN	Torque keyboard digital setting	SVC Set the torque keyboard number.	0.0% (0.0 ~ 100.0%)
F03.43 (0x032B) RUN	Torque input lower limit	SVC Set the torque input lower limit.	0.00% (0.0 ~ 100.00%)
F03.44 (0x032C) RUN	Lower limit corresponding setting	SVC Set the lower limit corresponding value.	0.0% (-200.0~200.0%)
F03.45 (0x032D) RUN	Torque input upper limit	SVC Set the upper limit of the torque input.	100.0% (0.0~100.0%)
F03.46 (0x032E) RUN	Upper limit corresponding setting	SVC Set the upper limit to correspond.	100.0% (-200.0~200.0%)

F03.47 (0x032F) RUN	Torque filtering time	SVC Set the torque limit action frequency range at low speed.	0.100s (0.000~6.000s)
F03.52 (0x0334) RUN	Torque command upper limit	SVC Set the upper limit of the output torque.	150.0% (0.0 ~ 200.0%)
F03.53 (0x0335) RUN	Torque command lower limit	SVC Set the lower limit of the output torque.	0.0% (0.0 ~ 200.0%)
F03.54 (0x0336) RUN	Torque control forward speed limit selection	SVC 0: Function code F03.56 is set; 1: Integrated keyboard potentiometer given × F03.56; 2: AI × F03.56; 3: Reserved; 4: Reserved 5: PUL × F03.56; 6: RS485 communication given × F03.56 7: Reserved	0 (0 ~ 7)
F03.55 (0x0337) RUN	Torque control reverse speed limit selection	SVC 0: Function code F03.57 is set; 1: Integrated keyboard potentiometer given × F03.57; 2: AI × F03.57; 3: Reserved; 4: Reserved 5: PUL × F03.57; 6: RS485 communication given × F03.57 7: Reserved	0 (0 ~ 7)
F03.56 (0x0338) RUN	Torque control forward speed maximum speed limit	SVC Set the torque control forward maximum speed limit.	100.0% (0.0~100.0%)
F03.57 (0x0339) RUN	Torque control anyway maximum speed limit	SVC Set the torque control reverse maximum speed limit.	100.0% (0.0~100.0%)
F03.58 (0x033A) RUN	Given torque gain switching frequency	SVC Set the given torque gain switching frequency.	2.00Hz (0.00 ~ 50.00Hz)
F03.59 (0x033B) RUN	Given torque gain	SVC Set the given torque gain.	100.0% (0.0 ~ 500.0%)

10.8 Group F04: V/F Control

F04.0x group: V/F control

Parameter (address) adjustable attribute	Name	Content	Factory default (setting range)
F04.00 (0x0400) STOP	Linear VF curve selection	V/F Used to select the type of V/F curve to meet different load features. 0: Straight line VF curve; 1-9: Respectively, a power VF curve of 1.1-1.9; 10: Square VF curve; 11: Custom VF curve;	0 (0 ~ 11)
F04.01 (0x0401) RUN	Torque boost	V/F 0.0%: automatic torque boost 0.1~30.0%: manual torque boost	0.0% (0.0 ~ 30.0%)
F04.02 (0x0402) RUN	Torque boost cutoff frequency	V/F Set the effective range of the torque boost function. When the output frequency exceeds this value, the torque boost function is cut off.	100.0% (0.0 ~ 100.0%)
F04.03 (0x0403) RUN	Slip compensation gain	V/F Set the slip compensation gain.	0.0% (0.0 ~ 200.0%)
F04.04 (0x0404) RUN	Slip compensation limit	V/F Set the slip compensation limit value.	100.0% (0.0 ~ 300.0%)

F04.05 (0x0405) RUN	Slip compensation filter time	V/F The slip compensation function needs to correctly input the motor nameplate parameters and learn the parameters to achieve the best results.	0.200 (0.000 ~ 6.000)
F04.06 (0x0406) RUN	Oscillation suppression gain	V/F By adjusting this value, low frequency resonance can be suppressed, but not too large; otherwise it will cause additional stability problems.	100.0% (0.0 ~ 900.0%)
F04.07 (0x0407) RUN	Oscillation suppression filter time	V/F Set the oscillation suppression filter time.	1.0s(0.0 ~ 100.0s)
F04.08 (0x0408) STOP	Output voltage percentage	V/F Set the output voltage percentage.	100.0% (25.0~120.0%)

F04.1x group: Custom V/F curve

Parameter (address) djustable attribute	Name	Content	Factory default (setting range)
F04.10 (0x040A) STOP	Self-setting voltage V1	V/F Self-setting voltage V1	3.0% (0.0 ~ 100.0%)
F04.11 (0x040B) STOP	Self-set frequency F1	V/F Self-set frequency F1	1.00Hz (0.00~Maximum frequency)
F04.12 (0x040C) STOP	Self-setting voltage V2	V/F Self-setting voltage V2	28.0% (0.0 ~ 100.0%)
F04.13 (0x040D) STOP	Self-set frequency F2	V/F Self-set frequency F2	10.0Hz (0.00~Maximum frequency)
F04.14 (0x040E) STOP	Self-setting voltage V3	V/F Self-setting voltage V3	55.0% (0.0 ~ 100.0%)
F04.15 (0x040F) STOP	Self-set frequency F3	V/F Self-set frequency F3	25.00Hz (0.00~Maximum frequency)
F04.16 (0x0410) STOP	Self-setting voltage V4	V/F Self-setting voltage V4	78.0% (0.0 ~ 900.0%)
F04.17 (0x0411) STOP	Self-set frequency F4	V/F Self-set frequency F4	37.5Hz (0.00~Maximum frequency)
F04.18 (0x0412) STOP	Self-setting voltage V5	V/F Self-setting voltage V5	100.0% (0.0~100.0%)
F04.19 (0x0413) STOP	Self-set frequency F5	V/F Self-set frequency F5	50.00Hz (0.00~Maximum frequency)

F04.2x group: Reserved

F04.3x group: V/F energy saving control

Parameter (address) djustable attribute	Name	Content	Factory default (setting range)
F04.30 (0x041E) STOP	Automatic energy saving control	V/F 0: Off 1: On	0 (0 ~ 1)
F04.31 (0x041F) STOP	Energy saving step frequency lower limit	V/F Set the lower limit of the energy saving buck frequency.	15.0Hz (0.0~50.0Hz)

F04.32 (0x0420) STOP	Energy-saving step-down voltage lower limit	V/F Set the lower limit of the energy-saving step-down voltage.	50.0% (20.0~100.0%)
F04.33 (0x0421) RUN	Energy-saving step-down voltage regulation rate	V/F Set the energy-saving step-down voltage regulation rate.	0.010V/MS (0.000~0.200 V/MS)
F04.34 (0x0422) RUN	Energy-saving voltage and voltage recovery rate	V/F Set the energy saving voltage and voltage recovery rate.	0.20V/MS (0.00~2.00 V/MS)

10.9 Group F05: Input Terminal

F05.0x group: Digital input terminal function

Parameter (address) djustable attribute	Name	Content	Factory default (setting range)
F05.00 (0x0500) STOP	Terminal X1 function selection	V/F SVC See the function of terminal X for details.	1 (0 ~ 63)
F05.01 (0x0501) STOP	Terminal X2 function selection	V/F SVC See the function of terminal X for details.	2 (0 ~ 63)
F05.02 (0x0502) STOP	Terminal X3 function selection	V/F SVC See the function of terminal X for details.	4 (0 ~ 63)
F05.03 (0x0503) STOP	Terminal X4 function selection	V/F SVC See the function of terminal X for details.	8 (0 ~ 63)

F05.1x group: Curve X1-X4 detection delay

Parameter (address) djustable attribute	Name	Content	Factory default (setting range)
F05.10 (0x050A) RUN	X1 effective detection delay	V/F SVC Delay time corresponding to the transition of the output terminal X1 from the inactive state to the active state	0.010 (0.000 ~ 6.000s)
F05.11 (0x050B) RUN	X1 invalid detection delay	V/F SVC Delay time corresponding to the transition of the output terminal X1 from the active state to the inactive state	0.010 (0.000 ~ 6.000s)
F05.12 (0x050C) RUN	X2 effective detection delay	V/F SVC Delay time corresponding to the transition of the output terminal X2 from the inactive state to the active state	0.010 (0.000 ~ 6.000s)
F05.13 (0x050D) RUN	X2 invalid detection delay	V/F SVC Delay time corresponding to the transition of the output terminal X2 from the active state to the inactive state	0.010 (0.000 ~ 6.000s)
F05.14 (0x050E) RUN	X3 effective detection delay	V/F SVC Delay time corresponding to the transition of the output terminal X3 from the inactive state to the active state	0.010 (0.000 ~ 6.000s)
F05.15 (0x050F) RUN	X3 invalid detection delay	V/F SVC Delay time corresponding to the transition of the output terminal X3 from the active state to the inactive state	0.010 (0.000 ~ 6.000s)
F05.16 (0x0510) RUN	X4 effective detection delay	V/F SVC Delay time corresponding to the transition of the output terminal X4 from the inactive state to the active state	0.330 (0.000 ~ 6.000s)
F05.17 (0x0511) RUN	X4 invalid detection delay	V/F SVC Delay time corresponding to the transition of the output terminal X4 from the active state to the inactive state	0.330 (0.000 ~ 6.000s)

		state	
--	--	-------	--

F05.2x group: Digital input terminal action selection

Parameter (address) djustable attribute	Name	Content	Factory default (setting range)
F05.20 (0x0514) STOP	Terminal control mode	V/F SVC 0: Two-wire system 1 1: Two-wire system 2 2: Three-wire system 1 3: Three-wire system 2	0 (0 ~ 3)
F05.21 (0x0515) STOP	Terminal start protection	V/F SVC 0: Off 1: On LED "0" digit: Terminal start protection when exiting abnormal LED "00" digit: Jog terminal start protection when exiting abnormal LED "000" digit: Start protection when the command channel is switched to the terminal LED "0000" digit: Reserved Free stop, emergency stop, forced stop, default on	0111 (0000 ~ 1111)
F05.22 (0x0516) RUN	X1 ~ X4 terminal characteristics selection	V/F SVC 0: Closed valid 1: Disconnected is valid LED "0" digit: X1 terminal LED "00" digit: X2 terminal LED "000" digit: X3 Terminal LED "0000" digit: X4 Terminal	0000 (0000 ~ 1111)
F05.25 (0x0519) STOP	Terminal UP/DW control selection	V/F SVC 0: Frequency power down storage 1: Frequency power down is not stored 2: Adjustable during operation, stop and clear	0 (0 ~ 2)
F05.26 (0x051A) RUN	Terminal UP/DW controls frequency increase and decrease rate	V/F SVC Set terminal UP/DW to control the frequency increase and decrease rate	0.50Hz/s (0.01~50.00Hz/s)
F05.27 (0x051B) RUN	Terminal emergency stop deceleration time	V/F SVC Set terminal emergency stop deceleration time	1.00s (0.01~650.00s)

F05.3x group: PUL terminal

Parameter (address) djustable attribute	Name	Content	Factory default (setting range)
F05.30 (0x051E) STOP	Reserved		
F05.31 (0x051F) RUN	PUL input minimum frequency	V/F SVC The minimum frequency accepted by the PUL, below the frequency signal of this value, the frequency converter will be processed at the minimum frequency.	0.00kHz (0.00~500.00kHz)
F05.32 (0x0520) RUN	PUL minimum frequency corresponding setting	V/F SVC Corresponding to the percentage of the set value	0.00% (0.00~100.00%)
F05.33 (0x0521) RUN	PUL input maximum frequency	V/F SVC The maximum frequency accepted by the PUL is higher than the frequency signal of this value, and the inverter will process at the maximum frequency. 0.00 to 50.000 kHz	50.00kHz (0.00~500.00kHz)
F05.34 (0x0522) RUN	PUL maximum frequency corresponding setting	V/F SVC Corresponding to the percentage of the set value	100.00% (0.00~100.00%)

F05.35 (0x0523) RUN	PUL filter time	V/F SVC Defines the size of the input pulse signal to be used to eliminate interfering signals.	0.200s (0.000~9.000s)
F05.36 (0x0524) RUN	PUL cutoff frequency	V/F SVC When the frequency is below of this parameter, the drive is no longer recognized. Processed at 0 Hz.	0.010kHz (0.000~1.000kHz)

F05.4x group: Analog (AI) type processing

Parameter (address) djustable attribute	Name	Content	Factory default (setting range)
F05.40 (0x0528) RUN	AI input signal type selection method	V/F SVC 0: DIP switch 1: Reserved	0 (0~1)
F05.43 (0x052B) RUN	Analog input curve selection	V/F SVC 0: Straight line (default) 1: Curve 1 2: Curve 2 LED "0" digit: AI LED "00" digit: Reserved LED "000" digit: Reserved LED "0000" digit: Reserved	0000 (0000~2222)

F05.5x group: Analog (AI) linear processing

Parameter (address) djustable attribute	Name	Content	Factory default (setting range)
F05.50 (0x0532) RUN	AI lower limit	V/F SVC Define the signal received by the terminal. The voltage signal below this value is processed by the limit value.	0.0% (0 0.0~100.0%)
F05.51 (0x0533) RUN	AI lower limit corresponding setting	V/F SVC Set the percentage of the corresponding set value	0.0% (-100.0~100.0%)
F05.52 (0x0534) RUN	AI upper limit	V/F SVC Define the signal received by the terminal. The voltage signal above this value is processed according to the	100.00% (0.00~100.00%)
F05.53 (0x0535) RUN	AI upper limit corresponding setting	V/F SVC Set the percentage of the corresponding set value	100.0% (0.00~100.0%)
F05.54 (0x0536) RUN	AI filter time	V/F SVC Defines the size of the analog signal to be used to eliminate interfering signals.	0.010s (0.000~6.000s)

F05.6x group: AI curve 1 processing

Parameter (address) djustable attribute	Name	Content	Factory default (setting range)
F05.60 (0x053C) RUN	Curve 1 lower limit	V/F SVC Set the lower limit of curve 1	0.0% (0.0 ~ 100.0%)
F05.61 (0x053D) RUN	Curve 1 lower limit corresponding setting	V/F SVC Corresponding set percentage	0.0% (0.0 ~ 100.0%)
F05.62 (0x053E) RUN	Curve 1 inflection point 1 input voltage	V/F SVC Set curve 1 inflection point 1 input voltage	30.0% (0.0 ~ 100.0%)
F05.63 (0x053F) RUN	Curve 1 inflection point 1 corresponding setting	V/F SVC Corresponding set percentage	30.00% (0.00~100.00%)

F05.64 (0x0540) RUN	Curve 1 inflection point 2 input voltage	V/F SVC Set curve 1 inflection point 2 input voltage	60.0% (0.0 ~ 100.0%)
F05.65 (0x0541) RUN	Curve 1 inflection point 2 corresponding setting	V/F SVC Corresponding set percentage	70.00% (0.00~100.00%)
F05.66 (0x0542) RUN	Curve 1 upper limit	V/F SVC Set the upper limit of curve 1	100.00% (0.00~100.00%)
F05.67 (0x0543) RUN	Curve 1 upper limit corresponding setting	V/F SVC Corresponding set percentage	100.0% (0.0 ~ 100.0%)

F05.7x group: AI curve 2 processing

Parameter (address) djustable attribute	Name	Content	Factory default (setting range)
F05.70 (0x0546) RUN	Curve 2 lower limit	V/F SVC Set the lower limit of curve 2	0.0% (0.0~100.0%)
F05.71 (0x0547) RUN	Curve 2 lower limit corresponding setting	V/F SVC Corresponding set percentage	0.0% (0.0~100.0%)
F05.72 (0x0548) RUN	Curve 2 inflection point 1 input voltage	V/F SVC Set curve 2 inflection point 1 input voltage	30.0% (0.0~100.0%)
F05.73 (0x0549) RUN	Curve 2 inflection point 1 corresponding setting	V/F SVC Corresponding set percentage	30.00% (0.00~100.00%)
F05.74 (0x054A) RUN	Curve 2 inflection point 2 input voltage	V/F SVC Set curve 2 inflection point 2 input voltage	60.0% (0.0 ~ 100.0%)
F05.75 (0x054B) RUN	Curve 2 inflection point 2 corresponding setting	V/F SVC Corresponding set percentage	70.00% (0.00~100.00%)
F05.76 (0x054C) RUN	Curve 2 upper limit	V/F SVC Set the upper limit of curve 2	100.00% (0.00~100.00%)
F05.77 (0x054D) RUN	Curve 2 upper limit corresponding setting	V/F SVC Corresponding set percentage	100.0% (0.0 ~ 100.0%)

F05.8x group: AI as a digital input terminal

Parameter (address) djustable attribute	Name	Content	Factory default (setting range)
F05.80 (0x0550) RUN	AI port to do digital input terminal feature selection	V/F SVC 0: Active low 1: Active high LED "0" digit: AI LED "00" digit: Reserved LED "000" digit: Reserved LED "0000" digit: Reserved	0000 (0000 ~ 1111)
F05.81 (0x0551) STOP	AI terminal function selection (as X)	V/F SVC See X terminal function	0 (0~63)
F05.82 (0x0552) RUN	AI high level setting	V/F SVC The input setting is greater than the high level setting, which is the input high level.	70.00% (0.00~100.00%)
F05.83 (0x0553) RUN	AI low level setting	V/F SVC Less than the low level setting is low.	30.00% (0.00~100.00%)

10.10 Group F06: Output Terminal

F06.0x group: AO (analog) output

Parameter (address) djustable attribute	Name	Content	Factory default (setting range)
F06.00 (0x0600) RUN	AO output mode selection	V/F SVC 0: 0~10V 1: 4.00~20.00mA 2: 0.00~20.00mA 3: Reserved 4: Reserved	0 (0 ~ 4)
F06.001 (0x0601) RUN	AO output selection	V/F SVC 0: Given frequency 1: Output frequency 2: Output current 3: Input voltage 4: Output voltage 5: Mechanical speed 6: Given torque 7: Output torque 8: PID given 9: PID feedback amount 10: Output power 11: Bus voltage 12: VS input value 13: AI input value 14: AS input value 15: PUL input value 16: Module temperature 1	0 (0 ~ 19)
F06.02 (0x0602) RUN	AO output gain	V/F SVC Adjust the value of the analog output of the terminal.	100.0% (0.0 ~ 200.0%)
F06.003 (0x0603) RUN	AO output bias	V/F SVC Set the A0 output offset. Used to adjust the zero point of the terminal output.	0.0% (-10.0~10.0%)
F06.04 (0x0604) RUN	AO output filtering	V/F SVC Defined as the size of the analog signal filtering used to eliminate interfering signals.	0.01s (0.0 ~ 6.00s)

F06.1x group: Reserved

F06.2x-F06.3 group x: Digital, relay output

Parameter (address) djustable attribute	Name	Content	Factory default (setting range)
F06.20 (0x0614) RUN	Output terminal polarity selection	V/F SVC 0: Positive polarity 1: Negative polarity LED "0" digit: Y terminal LED "00" digit: Relay output terminal 1 LED "000" digit: Reserved LED "0000" digit: Reserved	0000 (0000 ~ 1111)
F06.21 (0x0615) RUN	Output terminal Y	V/F SVC See terminal Y function	1 (0 ~ 63)
F06.22 (0x0616) RUN	Relay 1 output (TA-TB-TC)	V/F SVC See terminal Y function	4 (0 ~ 63)
F06.25 (0x0619) RUN	Y output ON delay time	V/F SVC Set the Y output ON delay time.	0.010s (0.000~60.000s)
F06.26 (0x061A) RUN	Relay 1 output ON delay time	V/F SVC Set relay 1 to output the ON delay time.	0.010s (0.000~60.000s)

F06.29 (0x061D) RUN	Y output OFF delay time	V/F SVC Set the Y output OFF delay time.	0.010s (0.000~60.000s)
F06.30 (0x061E) RUN	Relay 1 output OFF delay time	V/F SVC Set relay 1 output OFF delay time.	0.010s (0.000~60.000s)

F06.4x group: Frequency detection

Parameter (address) djustable attribute	Name	Content	Factory default (setting range)
F06.40 (0x0628) RUN	Frequency detection value 1	V/F SVC Set the frequency detection value 1	30.00Hz (0.00~Maximum frequency)
F06.41 (0x0629) RUN	Frequency detection amplitude 1	V/F SVC Set the frequency detection amplitude 1	1.00Hz (0.00~Maximum frequency)
F06.42 (0x062A) RUN	Frequency detection value 2	V/F SVC Set the frequency detection value 2	50.00Hz (0.00~Maximum frequency)
F06.43 (0x062B) RUN	Frequency detection range 2	V/F SVC Set the frequency detection range 2	1.00Hz (0.00~Maximum frequency)
F06.44 (0x062C) RUN	The given frequency reaches the detection range	V/F SVC Set the given frequency to reach the detection range	2.00Hz (0.00~Maximum frequency)

F06.5x group: Monitoring parameter comparator output

Parameter (address) djustable attribute	Name	Content	Factory default (setting range)
F06.50 (0x0632) RUN	Comparator 1 monitor selection	V/F SVC LED "0" and "00"digit: Setting yy setting in monitoring parameter number Cxx.yy 00~63 LED "000" and "0000" digit: Monitoring parameter number Cxx.yy xx setting 00~07	0001 (0000 ~ 0763)
F06.51 (0x0633) RUN	Comparator 1 upper limit	V/F SVC	3000 (0 ~ 65535)
F06.52 (0x0634) RUN	Comparator 1 lower limit	V/F SVC	0 (0 ~ 65535)
F06.53 (0x0635) RUN	Comparator 1 bias	V/F SVC	0 (0 ~ 1000)
F06.54 (0x0636) RUN	Action selection when sending CP1	V/F SVC 0: Continue running (digital terminal output only) 1: Alarm and free parking 2: Warning and continue to run 3: Forced shutdown	0 (0 ~ 3)
F06.55 (0x0637) RUN	Comparator 2 monitor selection	V/F SVC LED "0" and "00"digit: Setting yy setting in monitoring parameter number Cxx.yy 00~63 LED "000" and "0000" digit: Monitoring parameter number Cxx.yy xx setting 00~07	0002 (0000 ~ 0763)

F06.56 (0x0638) RUN	Comparator 2 upper limit	V/F SVC	100 (0 ~ 65535)
F06.57 (0x0639) RUN	Comparator 2 lower limit	V/F SVC	0 (0 ~ 65535)
F06.58 (0x063A) RUN	Comparator 2 bias	V/F SVC	0 (0 ~ 1000)
F06.59 (0x063B) RUN	Action selection when sending CP2	V/F SVC 0: Continue running (digital terminal output only) 1: Alarm and free parking 2: Warning and continue to run 3: Forced shutdown	0 (0 ~ 3)

F06.6x group: virtual input and output terminals

Parameter (address) djustable attribute	Name	Content	Factory default (setting range)
F06.60 (0x063C) STOP	Virtual vX1 terminal function selection	V/F SVC See terminal X function	0 (0 ~ 63)
F06.61 (0x063D) STOP	Virtual vX2 terminal function selection	V/F SVC See terminal X function	0 (0 ~ 63)
F06.62 (0x063E) STOP	Virtual vX3 terminal function selection	V/F SVC See terminal X function	0 (0 ~ 63)
F06.63 (0x063F) STOP	Virtual vX4 terminal function selection	V/F SVC See terminal X function	0 (0 ~ 63)
F06.64 (0x0640) RUN	vX terminal valid status source	V/F SVC 0: Internal connection with virtual vYn 1: Link to physical terminal Xn 2: Is the function code setting valid? LED "0" digit: Virtual vX1 LED "00" digit: Virtual vX2 LED "000" digit: Virtual vX3 LED "0000" digit: Virtual vX4	0000 (0000 ~ 2222)
F06.65 (0x0641) RUN	Virtual vX terminal function code setting valid status	V/F SVC 0: Invalid; 1: Valid LED "0" digit: Virtual vX1 LED "00" digit: Virtual vX2 LED "000" digit: Virtual vX3 LED "0000" digit: Virtual vX4	0000 (0000 ~ 1111)
F06.66 (0x0642) RUN	Virtual vY1 output selection	V/F SVC See Y terminal function	0 (0~31)
F06.67 (0x0643) RUN	Virtual vY2 output selection	V/F SVC See Y terminal function	0 (0~31)
F06.68 (0x0644) RUN	Virtual vY3 output selection	V/F SVC See Y terminal function	0 (0~31)
F06.69 (0x0645) RUN	Virtual vY4 output selection	V/F SVC See Y terminal function	0 (0~31)
F06.70 (0x0646) RUN	vY1 output ON delay time	V/F SVC	0.010s (0.000~60.000s)
F06.71 (0x0647) RUN	vY2 output ON delay time	V/F SVC	0.010s (0.000~60.000s)

F06.72 (0x0648) RUN	vY3 output ON delay time	V/F SVC	0.010s (0.000~60.000s)
F06.73 (0x0649) RUN	vY4 output ON delay time	V/F SVC	0.010s (0.000~60.000s)
F06.74 (0x064A) RUN	vY1 output OFF delay time	V/F SVC	0.010s (0.000~60.000s)
F06.75 (0x064B) RUN	vY2 output OFF delay time	V/F SVC	0.010s (0.000~60.000s)
F06.76 (0x064C) RUN	vY3 output OFF delay time	V/F SVC	0.010s (0.000~60.000s)
F06.77 (0x064D) RUN	vY4 output OFF delay time	V/F SVC	0.010s (0.000~60.000s)

10.11 Group F07: Operation Control

F07.0x group: Start control

Parameter (address) djustable attribute	Name	Content	Factory default (setting range)	Notes
F07.00 (0x0700) STOP	Start mode	V/F SVC 0: Started by the start frequency 1: DC braking first starts again from the starting frequency 2: Start after the speed tracking and direction judgment	0 (0 ~ 2)	S/T2 models do not support speed tracking
F07.01 (0x0701) STOP	Start pre-excitation time	V/F SVC Just asynchronous machine vector control (no PG) supports pre-excitation, others would be	0.00s (0.00~60.00s)	S/T2 models do not support starting pre-
F07.02 (0x0702) STOP	Starting frequency	V/F SVC When the given frequency is less than this value, it does not start and is in standby state.	0.50Hz (0.00~Upper limit frequency digital setting)	
F07.03 (0x0703) STOP	Start protection selection	V/F SVC 0: Off 1: On LED "0" digit: Terminal start protection when exiting abnormal LED "00" digit: Jog terminal start protection when exiting abnormal LED "000" digit: Terminal start protection when the command channel is switched to the terminal LED "0000" digit: Reserved Note: The terminal start protection is enabled by default when the free stop, emergency stop and forced stop commands are valid.	0111 (0000~1111)	
F07.05 (0x0705) STOP	Direction of rotation	V/F SVC LED "0" digit: Reverse the running direction 0: The direction is unchanged 1: Direction reversal LED "00" digit: No direction of operation 0: Allow forward and reverse commands 1: Only forward commands are allowed 2: Only reverse command is allowed LED "000" digit: Frequency Control Command Direction 0: The frequency control direction is invalid. 1: Frequency control direction is valid LED "0000" digit: Reserved	0000 (0000~1111)	

F07.06 (0x0706) STOP	Power failure restart action selection	V/F SVC 0: Invalid 1: Valid	0 (0 ~ 1)	
F07.07 (0x0707) STOP	Power failure restart waiting time	V/F SVC	0.50s (0.00~60.00s)	

F07.1x group: Shutdown control

Parameter (address) djustable attribute	Name	Content	Factory default (setting range)
F07.10 (0x070A) RUN	Stop mode	V/F SVC 0: Deceleration stop 1: Free stop	0 (0 ~ 1)
F07.11 (0x070B) RUN	Shutdown detection frequency	V/F SVC When decelerating to stop, when the inverter output frequency is less than this value, it will enter the stop state.	0.50Hz (0.00~Upper limit frequency digital setting)
F07.12 (0x070C) STOP	Stop and restart limit time	V/F SVC Waiting time after restarting after shutdown	0.00s (0.00~60.00s)
F07.15 (0x070F) RUN	Insufficient lower limit frequency action selection	V/F SVC 0: Run according to frequency command 1: Free running stops, enters the pause state 2: The following limited frequency operation 3: Zero speed operation	0 (0~3)
F07.16 (0x0710) RUN	Zero speed torque retention factor	V/F SVC	60.0% (0.0~150.0%)
F07.17 (0x0711) RUN	Zero speed torque holding time	V/F SVC	0s (0.0~6000.0s)
F07.18 (0x0712) STOP	Positive reversal dead time	V/F SVC Positive and negative switching, zero frequency maintenance time	0.0s (0.0~120.0s)

F07.2x group: DC braking and speed tracking

Parameter (address) djustable attribute	Name	Content	Factory default (setting range)
F07.20 (0x0714) STOP	Braking current before starting	V/F SVC	60.0% (0.0~150.0%)
F07.21 (0x0715) STOP	Braking time before starting	V/F SVC	0.0s (0.0~60.0s)
F07.22 (0x0716) STOP	DC braking start frequency	V/F SVC	1.00Hz (0.00~50.00Hz)
F07.23 (0x0717) STOP	DC braking current	V/F SVC The reference is the rated current of the inverter, and the internal limit does not exceed the rated current of the motor.	60.0% (0.0~150.0%)
F07.24 (0x0718) STOP	DC braking time during shutdown	V/F SVC	0.0s (0.0~60.0s)

F07.25 (0x0719) STOP	Speed tracking mode	V/F SVC LED "0" digit: Search method 0: Search from the maximum frequency 1: Search from stop frequency LED "00" digit: Reverse search 0: Off 1: Open LED "000" digit: Search Source 0: Software search 1: Hardware search LED "0000" digit: Reserved	0000 (0000~0111)
F07.26 (0x071A) STOP	Speed tracking speed	V/F SVC	0.5s (0.0~60.0s)
F07.27 (0x071B) STOP	Speed tracking stop delay	V/F SVC	1.00s (0.0~60.0s)
F07.28 (0x071C) STOP	Speed tracking current	V/F SVC	120.0% (0.0~400.0%)

F07.3x group: Jog

Parameter (address) djustable attribute	Name	Content	Factory default (setting range)
F07.30 (0x071E) RUN	Jog running frequency setting	V/F SVC	5.00Hz (0.00~Maximum frequency)
F07.31 (0x071F) RUN	Jog acceleration time	V/F SVC	10.0s (0.0~650.0s)
F07.32 (0x0720) RUN	Jog deceleration time	V/F SVC	10.0s (0.0~650.0s)
F07.33 (0x0721) RUN	Jog S curve selection	V/F SVC 0: Invalid 1: Valid	0 (0~1)
F07.34 (0x0722) RUN	Jog stop mode selection	V/F SVC 0: Same as F7.10 1: Deceleration only	0 (0~1)

F07.4x group: Start, stop frequency maintenance and skip frequency

Parameter (address) djustable attribute	Name	Content	Factory default (setting range)
F07.40 (0x0728) STOP	Maintain frequency at startup	V/F SVC Startup maintenance frequency is greater than the start frequency, less than the upper limit digital set frequency	0.50Hz (0.00~Upper limit frequency digital setting)
F07.41 (0x0729) STOP	Maintain frequency time at startup	V/F SVC The set value needs to be greater than the start frequency, and when it is insufficient, press the start frequency.	0.0s (0.0~60.0s)
F07.42 (0x072A) STOP	Maintain frequency during shutdown	V/F SVC	0.50Hz (0.00~Upper limit frequency digital setting)
F07.43 (0x072B) STOP	Maintain frequency time during shutdown	V/F SVC The terminal DC braking and jogging are invalid. When the stop DC braking is valid, it is invalid when the shutdown maintenance frequency is less than the DC braking frequency. No stop DC braking, it's invalid when the shutdown maintenance frequency is less than the shutdown detection frequency.	0.0s (0.0~60.0s)

F07.44 (0x072C) RUN	Jump frequency 1	V/F SVC	0.00Hz (0.00~Maximum frequency)
F07.45 (0x072D) RUN	Jump frequency amplitude	V/F SVC	0.00Hz (0.00~Maximum frequency)
F07.46 (0x072E) RUN	Jump frequency 2	V/F SVC	0.00Hz (0.00~Maximum frequency)
F07.47 (0x072F) RUN	Jump frequency amplitude	V/F SVC	0.00Hz (0.00~Maximum frequency)

10.12 Group F08: Auxiliary Control

F08.0x group: Counting and timing

Parameter (address) djustable attribute	Name	Content	Factory default (setting range)
F08.00 (0x0800) RUN	Counter input source	V/F SVC 0: normal X terminal 1: input terminal PUL 2~5: Reserved	0 (0 ~ 5)
F08.01 (0x0801) RUN	Count input crossover	V/F SVC	0 (0 ~ 6000)
F08.02 (0x0802) RUN	Counter maximum	V/F SVC	1000 (0 ~ 65000)
F08.03 (0x0803) RUN	Counter setting	V/F SVC	500 (0 ~ 65000)
F08.04 (0x0804) RUN	Pulse number per meter	V/F SVC Count value per meter	10.0 (0.1~6500.0)
F08.05 (0x0805) STOP	Set length	V/F SVC Add a length to the output, one terminal length reset	1000 (0 ~ 65000M)
F08.06 (0x0806) STOP	Actual length	V/F SVC Power is not saved, consider whether the power is saved	0 (0 ~ 65000M)
F08.07 (0x0807) STOP	Timer time unit	V/F SVC 0: Second 1: Minute 2: Hour	0 (0 ~ 2)
F08.08 (0x0808) STOP	Timer setting	V/F SVC	0 (0 ~ 65000)

F08.1x group: Reserved

F08.2x group: Reserved

F08.3x group: Swing frequency control

Parameter (address) djustable attribute	Name	Content	Factory default (setting range)
F08.30 (0x081E) STOP	Swing frequency control	V/F SVC 0: Swing control is invalid 1: Swing frequency control is effective	0 (0 ~ 1)

F08.31 (0x081F) STOP	Swing frequency amplitude control	V/F SVC LED "0" digit: Startup mode 0: Automatic 1: Terminal manual LED "00" digit: Swing amplitude control: 0: Relative center frequency 1: Relative maximum frequency. LED "000" digit: Preset frequency enable: 0: Not enabled 1: Enabled LED "0000" digit: Reserved	0000 (0000~0111)
F08.32 (0x0820) STOP	Swing frequency preset frequency	V/F SVC	0.00Hz (0-upper frequency)
F08.33 (0x0821) STOP	Swing frequency preset frequency waiting time	V/F SVC	0.0s (0.0~3600.0s)
F08.34 (0x0822) STOP	Swing frequency amplitude	V/F SVC	10.0% (0.0~50.0%)
F08.35 (0x0823) STOP	Kick frequency	V/F SVC	10.0% (0.0~50.0%)
F08.36 (0x0824) STOP	Triangle wave rise time	V/F SVC	5.00s (0.1~999.9s)
F08.37 (0x0825) STOP	Triangle wave fall time	V/F SVC	5.00s (0.0~100.0s)

10.13 Group F09: Reserved

10.14 Group F10: Protection Parameters

F10.0x group: Current protection

Parameter (address) djustable attribute	Name	Content	Factory default (setting range)
F10.00 (0x0A00) RUN	Overcurrent suppression	V/F SVC The automatic limiting output current does not exceed the set overcurrent suppression point to prevent overcurrent faults from being triggered by excessive current. 0: Inhibition is always valid 1: Acceleration/deceleration is valid, constant speed is invalid	0 (0 ~ 1)
F10.01 (0x0A01) RUN	Overcurrent suppression point	V/F SVC Set the load current limit level, 100% corresponds to the rated motor current.	160.0% (0.0 ~ 300.0%)
F10.02 (0x0A02) RUN	Overcurrent suppression gain	V/F SVC Set the response effect of overcurrent suppression.	100.0% (0.0 ~ 500.0%)
F10.03 (0x0A03) STOP	Current protection setting 1	V/F SVC Set whether current-related protection is enabled LED "0" digit: wave-by-wave current limit (CBC) 0: Off 1: On LED "00" digit: OC protection interference suppression 0: Normal 1: Primary interference suppression 2: Secondary interference suppression LED "000" digit: SC Protection Interference Suppression 0: Normal 1: Primary interference suppression 2: Secondary interference suppression LED "0000" digit: Reserved	0001 (0000~0221)

F10.04 (0x0A04) STOP	Current protection setting 2	V/F SVC LED unit: reserved 0: Off 1: On	0001 (0000~0001)
----------------------------	------------------------------	--	---------------------

F10.1x group: voltage protection

Parameter (address) djustable attribute	Name	Content	Factory default (setting range)	Notes
F10.10 (0x0A0A) STOP	Bus overvoltage hardware protection	V/F SVC Set whether the bus overvoltage hardware protection function is enabled. 0: Off 1: On	0 (0 ~ 1)	
F10.11 (0x0A0B) STOP	Bus overvoltage suppression	V/F SVC When the bus voltage is greater than the overvoltage suppression point, it will slow down or stop the acceleration and deceleration to prevent overvoltage faults. LED "0" digit: Overvoltage suppression function 0: Off 1: Only open when decelerating 2: Both open and decelerate LED "00" digit: Overexcitation function 0: Off 1: On	0012 (0000 ~0012)	
F10.12 (0x0A0C) STOP	Bus overvoltage suppression point	V/F SVC Set bus voltage value for trigger overvoltage suppression function	T3: 780 S2: 370 (T3: 650 ~760 S2: 340 ~380) Also subject to overvoltage limit	T3 overvoltage point: 820V (750 ~840) S2 overvoltage point: 400V (360 ~410)
F10.13 (0x0A0D) RUN	Bus overvoltage suppression gain	V/F SVC Set the response of overvoltage suppression	100.0% (0.0~500.0%)	
F10.14 (0x0A0E) RUN	Energy brake enable	V/F SVC Set whether the energy brake function is on 0: off 1: Turn on, but turn off the overvoltage suppression function 2: Turn on, and turn on the overvoltage suppression function.	2 (0 ~2)	
F10.15 (0x0A0F) RUN	Energy consumption braking action voltage	V/F SVC Set the energy consumption braking action voltage, when the bus voltage is greater than this value, the energy consumption brake starts to act.	T3: 740 S2: 360 (T3:650 ~800 S2:350 ~390) Also subject to overvoltage limit	T3 overvoltagepoint : 820V (750 ~840) S2 overvoltagepoint 400V (360 ~410)
F10.16 (0x0A10) STOP	Bus undervoltage suppression	V/F SVC When the bus voltage is lower than the undervoltage suppression point, the operating frequency is automatically adjusted to suppress the bus voltage from decreasing, preventing the undervoltage fault. 0: Off 1: On	0 (0 ~ 1)	

F10.17 (0x0A11) STOP	Bus undervoltage suppression point	V/F SVC Set bus voltage value for trigger undervoltage suppression function	T3: 430 S2: 240 (T3: 350 ~450 S2: 180 ~260) Also subject to overvoltage limit	T3 overvoltagepoint : 820V (750 ~840) S2 overvoltagepoint 400V (360 ~410)
F10.18 (0x0A12) RUN	Bus undervoltage suppression gain	V/F SVC Set the response effect of undervoltage suppression	100.0% (0.0~500.0%)	
F10.19 (0x0A13) STOP	Bus undervoltage protection point	V/F SVC The lower limit voltage allowed by the set bus voltage. Below this value, the inverter reports an undervoltage fault.	T3: 320 S2: 190 (T3: 300 ~400 S2: 160 ~240) Also subject to overvoltage limit	T3 overvoltagepoint : 820V (750 ~840) S2 overvoltagepoint 400V (360 ~410)

F10.2x group: Auxiliary protection

Parameter (address) djustable attribute	Name	Content	Factory default (setting range)
F10.20 (0x0A14) STOP	Input and output phase loss protection options	V/F SVC Set whether the input and output phase loss protection functions are enabled. LED "0" digit: Output phase loss protection 0: Off 1: On LED "00" digit: Input phase loss protection 0: Off 1: On, detected the input missing phase report warning A.ILF, continue to run 2: Turn on, detect input missing phase report fault E.ILF, free stop	021 (000 ~ 121)
F10.21 (0x0A15) STOP	Input phase loss threshold	V/F SVC Set the percentage of voltage detection of the input phase loss detection function, 100% corresponds to the rated bus voltage	10% (0 ~30.0%)
F10.22 (0x0A16) STOP	Ground short circuit protection option	V/F SVC Set whether the inverter output and the inverter cooling fan ground short circuit protection function are enabled. LED "0" digit: Output short circuit protection 0: Off 1: On LED "00" digit: Fan to ground short circuit protection 0: Off 1: On	11 (00 ~12)
F10.23 (0x0A17) RUN	Fan ON/OFF control selection	Set the inverter cooling fan operation mode 0: The fan runs after the inverter is powered on. 1: After the shutdown, the fan operation is related to temperature, and the operation is running. 2: After the shutdown, the fan stops after F10.24, and the operation is related to temperature.	1 (0~2)
F10.24 (0x0A18) STOP	Fan control delay time	V/F SVC Set the time from when the run command is canceled to when the cooling fan stops running.	30.00s (0 ~600.00)
F10.25 (0x0A19) RUN	Inverter overheating oH1 detection level	V/F SVC Set the temperature value of the inverter overheat warning, which is greater than the value to report the overheat warning.	80.0°C (0 ~100.0)

F10.3x group: Load protection

Parameter (address) djustable attribute	Name	Content	Factory default (setting range)
F10.30 (0x0A1E) STOP	Motor overload protection curve coefficient	V/F SVC Set the coefficient of overload protection for the load motor. Increasing this value can increase the overload capacity of the motor.	100.0% (0 ~250.0%)
F10.31 (0x0A1F) STOP	Selection of inverter overload characteristics at low speed	V/F SVC When the low speed (less than 5Hz) is set, the overload protection function of the inverter is valid. 0: Invalid 1: Valid	0 (0 ~1)
F10.32 (0x0A20) STOP	Load warning checkout setting	V/F SVC Set the inverter load warning detection mode and the early warning mode at this time LED "0" digit: Load warning detection 1 setting 0: no detection 1: Detection load is too large 2: Excessive load detection only at constant speed 3: Insufficient detection load 4: Insufficient load detection only at constant speed LED "00" digit: Alarm setting when the alarm is detected 0: Continue to run, report A.LD1 1: Free stop, reported to E.LD1 LED "000" digit: Load Warning Checkout 2 Settings 0: no detection 1: Detection load is too large 2: Excessive load detection only at constant speed 3: Insufficient detection load 4: Insufficient load detection only at constant speed LED "0000" digit: Early warning set when load warning is detected 2 0: Continue to run, report A.LD1 1: Free stop, reported to E.LD1	0000 (0000 ~1414)
F10.33 (0x0A21) STOP	Load warning detection level 1	V/F SVC Set the detection value of load warning 1 When VF is controlled, this value is 100% corresponding to the rated current of the motor. When vector control, this value corresponds to 100% of the rated output torque of the motor.	130.0% (0 ~200.0%)
F10.34 (0x0A22) STOP	Load warning detection time 1	V/F SVC Set the duration of the detected load warning 1 and the load is greater than the load warning detection level for the duration, and the load warning is detected.	5.0s (0 ~60.0)
F10.35 (0x0A23) STOP	Load warning detection level 2	V/F SVC Set the detection value of load warning 2 When VF is controlled, this value is 100% corresponding to the rated current of the motor. When vector control, this value corresponds to 100% of the rated output torque of the motor.	130.0% (0 ~200.0%)
F10.36 (0x0A24) STOP	Load warning detection time 2	V/F SVC Set the duration of the detected load warning 2, the load is greater than the load warning detection level and continue for that time, and the load warning is detected 2	5.0s (0 ~60.0)

F10.4x group: Stall protection

Parameter (address) djustable attribute	Name	Content	Factory default (setting range)
---	------	---------	---------------------------------

F10.40 (0x0A28) STOP	Too large speed deviation protection action	V/F SVC Set the warning detection mode selection and alarm mode selection when the motor reference speed and feedback speed deviation are too large LED "0" digit: Check out options 0: No detection 1: Only at constant speed detection 2: Always testing LED "00" digit: Alarm selection 0: Free stop and report failure 1: Alarm and continue to run	00 (00 ~12)
F10.41 (0x0A29) STOP	Speed deviation excessive detection threshold	V/F SVC Set the detected value whose speed deviation is too large. This value corresponds to F01.10 [maximum frequency].	10.0% (0 ~60.0%)
F10.42 (0x0A2A) STOP	Speed deviation too large detection time	V/F SVC Set the duration of the detection speed deviation too large, the deviation of the given speed and feedback speed is greater than F10.41 and continues to be like that, an early warning of excessive speed deviation is detected.	2s (0 ~60)
F10.43 (0x0A2B) STOP	Speed protection action	V/F SVC Set the alarm detection mode selection and alarm mode selection when the motor is rotating too fast LED "0" digit: check out options 0: No detection 1: Only at constant speed detection 2: Always testing LED "00" digit: Alarm selection 0: Free stop and report failure 1: Alarm and continue to run	00 (00 ~12)
F10.44 (0x0A2C) STOP	Rapid detection threshold	V/F SVC Set the detection value of the fast warning, which corresponds to F01.10 [maximum frequency]	110.0% (0 ~150.0%)
F10.45 (0x0A2D) STOP	Rapid speed detection time	V/F SVC Set the duration of the detection of the rotating speed, the feedback speed is greater than F10.44 and continues like that, and the speed warning is detected.	0.01s (0 ~2)

F10.5x group: Fault recovery protection

Parameter (address) adjustable attribute	Name	Content	Factory default (setting range)
F10.50 (0x0A32) STOP	Failure self-recovery	V/F SVC Set the number of fault self-recovery that is allowed to be performed. Note: A value of 0 indicates that the fault self-recovery function is turned off; otherwise it indicates that the function is enabled.	0 (0 ~10)
F10.51 (0x0A33) STOP	Failure self-recovery interval	V/F SVC Set the waiting time before the inverter resets to the time before each reset.	1.0s (0 ~100.0)
F10.52 (0x0A34) STOP	Numbers of failures recovered	V/F SVC Indicates the number of self-recovery faults that have been performed. This parameter is a read-only parameter.	0

10.15 Group F11: Operator Parameters

F11.0x group: Button operation

Parameter (address) djustable attribute	Name	Content	Factory default (setting range)
F11.00 (0x0B00) RUN	Key lock selection	V/F SVC 0: Not locked 1: Keyboard function parameter modification lock 2: Function parameters and non-start stop button lock 3: Function parameters and button full lock	0 (0 ~ 3)
F11.01 (0x0B01) RUN	Key lock password	V/F SVC	0 (0 ~ 65535)
F11.02 (0x0B02) STOP	Keyboard multi-function key selection	V/F SVC 0: Invalid 1: Reverse run key 2: Forward jog operation key 3: Reverse jog run key 4: Keyboard command channel and terminal naming channel switch 5: Keyboard command channel and communication naming channel switch 6: Terminal command channel and communication naming channel switch 7: Keyboard, terminal, communication command channel cycle switching	1 (0 ~ 7)
F11.03 (0x0B03) STOP	Keyboard STOP button settings	V/F SVC 0: Non-keyboard control mode is invalid 1: Non-keyboard control mode stops according to stop mode 2: Non-keyboard control mode stops in free mode	0 (0 ~ 2)
F11.04 (0x0B04) STOP	Status interface up and down keys (knob) function selection	V/F SVC LED "0" digit: Keyboard up and down keys to modify the selection 0: Invalid 1: Used to adjust the frequency keyboard given F01.09 2: Used to adjust the PID keyboard given F13.01 3: Keyboard up and down keys to modify the parameter number setting LED "00" digit: Power-down storage 0: Frequency is not stored when power is off 1: Frequency power down storage LED "000" digit: Action Limit 0: Adjustable operation stop 1: Adjustable only during operation, stop and keep 2: Adjustable during operation, stop and clear LED "0000" digit: Reserved	0011 (0000~0213)
F11.05 (0x0B05) RUN	Up and down keys to quickly change the parameter code setting	V/F SVC LED "0" and "00" digit: yy setting in function parameter number Fxx.yy 00~99 LED "000" and "0000" digit: xx setting in function parameter number Fxx.yy 00~15	0109 (0000 ~ 1563)
F11.06 (0x0B06) STOP	Keyboard command key selection	V/F SVC LED "0" digit: Built-in, external keyboard button commands (run command, stop/reset command) 0: External priority, when the external is valid, the built-in is invalid. 1: Built-in priority, when the built-in is valid, the external is invalid 2: Internal and external are valid, the stop/reset command takes precedence; when both forward and reverse are active, and the command is invalid. LED "00" digit: Keyboard communication options 0: Both internal and external keyboards are valid 1: Only the built-in keyboard is valid	0000 (0000 ~ 1122)

F11.1x group: Status interface cyclic monitoring

Parameter (address) djustable attribute	Name	Content	Factory default (setting range)
F11.10 (0x0B0A) STOP	Status interface left shift, right shift key function selection	V/F SVC LED "0" digit: Left shift key to adjust the first line of monitoring 0: Invalid, 1: Valid LED "00" digit: Right shift key to adjust the second line of monitoring 0: Invalid, 1: Valid	0011 (0000 ~ 0011)
F11.11 (0x0B0B) RUN	Parameter 1 showed up on first line of the keyboard	V/F SVC LED "0" and "00" digit: Setting yy setting in monitoring parameter number Cxx.yy 00~63 LED "000" and "0000" digit: Monitoring parameter number Cxx.yy xx setting 00~07	0000 (0000 ~ 0763)
F11.12 (0x0B0C) RUN	Parameter 2 showed up on first line of the keyboard	V/F SVC LED "0" and "00" digit: Setting yy setting in monitoring parameter number Cxx.yy 00~63 LED "000" and "0000" digit: Monitoring parameter number Cxx.yy xx setting 00~07	0001 (0000 ~ 0763)
F11.13 (0x0B0D) RUN	Parameter 3 showed up on first line of the keyboard	V/F SVC LED "0" and "00" digit: Setting yy setting in monitoring parameter number Cxx.yy 00~63 LED "000" and "0000" digit: Monitoring parameter number Cxx.yy xx setting 00~07	0002 (0000 ~ 0763)
F11.14 (0x0B0E) RUN	Parameter 4 showed up on first line of the keyboard	V / F SVC LED "0" and "00" digit: Monitor parameter number Cxx.yy YY setting 00~63 LED "000" and "0000" digit: Monitoring parameter number Cxx.yy XX setting 00~07	0011 (0000 ~ 0763)
F11.15 (0x0B0F) RUN	Parameter 1 showed up on second line of the keyboard	V/F SVC LED "0" and "00" digit: Setting yy setting in monitoring parameter number Cxx.yy 00~63 LED "000" and "0000" digit: Monitoring parameter number Cxx.yy xx setting 00~07	0002 (0000 ~ 0763)
F11.16 (0x0B10) RUN	Parameter 2 showed up on second line of the keyboard	V / F SVC LED "0" and "00" digit: Monitor parameter number Cxx.yy YY setting 00~63 LED "000" and "0000" digit: Monitoring parameter number Cxx.yy XX setting	0004 (0000 ~ 0763)
F11.17 (0x0B11) RUN	Parameter 3 showed up on second line of the keyboard	V/F SVC LED "0" and "00" digit: Setting yy setting in monitoring parameter number Cxx.yy 00~63 LED "000" and "0000" digit: Monitoring parameter number Cxx.yy xx setting 00~07	0010 (0000 ~ 0763)
F11.18 (0x0B12) RUN	Parameter 4 showed up on second line of the keyboard	V/F SVC LED "0" and "00" digit: Setting yy setting in monitoring parameter number Cxx.yy 00~63 LED "000" and "0000" digit: Monitoring parameter number Cxx.yy xx setting 00~07	0012 (0000 ~ 0763)

F11.2x group: Monitoring parameter control

Parameter (address) djustable	Name	Content	Factory default (setting)	Notes
F11.20 (0x0B14) RUN	Keyboard display item settings	V/F SVC LED "0" digit: Output frequency display selection 0: Target frequency 1: Operating frequency LED "00" digit: Reserved 0: Invalid 1: Active power to remove stator resistance loss LED "000" digit: Power Display Dimensions 0: Power display percentage (%) 1: Power display kilowatt (KW) LED "0000" digit: Reserved	0000 (0000 ~ 1111)	
F11.21 (0x0B15) RUN	Speed display factor	V/F SVC	100.0% (0.0~500.0%)	
F11.22 (0x0B16) RUN	Power display factor	V/F SVC	100.0% (0.0~500.0%)	
F11.23 (0x0B17) RUN	Monitoring parameter group display selection	V/F SVC LED "0" digit: Reserved 0: Invalid 1: Valid LED "00" digit: C05 display selection 0: Automatically switch according to the control mode 1:VF mode related parameters 2: VC mode related parameters LED "000" digit: C00.40~C00.63 display selection 0: Not displayed 1: Display LED "0000" digit: Reserved	0000 (0000 ~ FFFF)	
F11.24 (0x0B18) RUN	Reserved			
F11.25 (0x0B19) STOP	Display selection when the motor is self-tuning	V/F SVC 0: Display the status of the self-learning process 1: Do not display the status of the self-learning process	0 (0 ~ 1)	S/T2 models do not support this parameter.

F11.3x group: Keyboard special features

Parameter (address) djustable attribute	Name	Content	Factory default (setting range)
F11.30 (0x0B1E) STOP	RD05 serial port function selection	V/F SVC 0: RS485 1: External keyboard The terminal 485 bus and the external keyboard function are selected one by one. When the external keyboard is selected, the 485 bus (master/slave) cannot be used.	0 (0 ~ 1)
F11.31 (0x0B1F) RUN	Keyboard potentiometer lower limit voltage	V/F SVC	0.50v (0.00-3.00v)
F11.32 (0x0B20) RUN	Keyboard potentiometer lower limit corresponding value	V/F SVC	0.00% (0.00-100.00%)
F11.33 (0x0B21) RUN	Keyboard potentiometer upper limit voltage	V/F SVC	2.80v (0.00-3.00v)

F11.34 (0x0B22) RUN	Keyboard potentiometer upper limit corresponding value	V/F SVC	100.0% (0.00-100.00%)
---------------------------	--	---------	--------------------------

10.16 Group F12: Communication Parameters

F12.0x group: MODBUS slave parameters

Parameter (address) adjustable attribute	Name	Content	Factory default (setting range)
F12.00 (0x0C00) STOP	Master-slave choice	V/F SVC 0: Slave 1: Host	0 (0 ~ 1)
F12.01 (0x0C01) STOP	Modbus communication address	V/F SVC	1 (1 ~ 247)
F12.02 (0x0C02) STOP	Communication baud rate selection	V/F SVC 0: 1200 bps 1: 2400 bps 2: 4800 bps 3: 9600 bps 4: 19200 bps 5: 38400 bps 6: 57600 bps	3 (0 ~ 6)
F12.03 (0x0C03) STOP	Modbus data format	V/F SVC 0: (N, 8, 1) no parity, Data bits: 8, Stop position: 1 1: (E, 8, 1) even parity, Data bits: 8, Stop position: 1 2: (O, 8, 1) odd parity, Data bits: 8, Stop position: 1 3: (N, 8, 2) no parity, Data bits: 8, Stop position: 2 4: (E, 8, 2) even parity, Data bits: 8, Stop position: 2 5: (O, 8, 2) odd parity, Data bits: 8, Stop position: 2	0 (0 ~ 5)
F12.04 (0x0C04) RUN	Modbus transmission response processing	V/F SVC 0: The writing operation has a response 1: The writing operation has no response	0 (0 ~ 1)
F12.05 (0x0C05) RUN	Modbus communication response delay	V/F SVC	0ms (0 ~ 500ms)
F12.06 (0x0C06) RUN	Modbus communication timeout failure time	V/F SVC	1.0s (0.1 ~ 100s)
F12.07 (0x0C07) RUN	Communication disconnection processing	V/F SVC 0: Do not detect timeout failure 1: Fault and free parking 2: Warning and continue to run 3: Forced shutdown	0 (0 ~ 3)
F12.08 (0x0C08) RUN	Receive data (address 0x3000) zero bias	V/F SVC	0.00 (-100.00-100.00)
F12.09 (0x0C09) RUN	Receive data (address 0x3000) gain	V/F SVC	100.0% (0.0~500.0%)

F12.1x group: MODBUS host parameters

Parameter (address) djustable attribute	Name	Content	Factory default (setting)
F12.10 (0x0C0A) RUN	Host cyclically send parameter selection	V/F SVC LED "0", "00", "000", "0000" digit: 0: Invalid 1: Host running command 2: Host given frequency 3: Host output frequency 4: Host upper limit frequency 5: The given torque of the host 6: Host output torque 7: Reserved 8: Reserved 9: Host PID given A: Host PID feedback B: Reserved C: Active current component	0031 (0000 ~ CCCC)
F12.11 (0x0C0B) RUN	Frequency given custom address setting	V/F SVC	0000 (0000 ~ FFFF)
F12.12 (0x0C0C) RUN	Command given custom address settings	V/F SVC	0000 (0000 ~ FFFF)
F12.13 (0x0C0D) RUN	Command given as forward run command value	V/F SVC	0001 (0000 ~ FFFF)
F12.14 (0x0C0E) RUN	Command given as reverse run command value	V/F SVC	0002 (0000 ~ FFFF)
F12.15 (0x0C0F) RUN	Command given as stop command value	V/F SVC	0005 (0000 ~ FFFF)
F12.16 (0x0C10) RUN	Command given as reset command value	V/F SVC	0007 (0000 ~ FFFF)

10.17 Group F13: Process PID Control

F13.00-F13.06: PID given and feedback

Parameter (address) djustable attribute	Name	Content	Factory default (setting range)
F13.00 (0x0D00) RUN	PID controller given signal source	V/F SVC 0: Keyboard digital PID given 1: Keyboard analog potentiometer given 2: Current/voltage analog AI given 3: Reserved 4: Reserved 5: Terminal pulse PUL given 6: RS485 communication given 7: Option card 8: Terminal selection 9: Communication given active current	0 (0 ~ 9)
F13.01 (0x0D01) RUN	Keyboard digital PID given / feedback	V/F SVC	50.0% (0.00~100.0%)
F13.02 (0x0D02) RUN	PID given change time	V/F SVC	1.00s (0.00~60.00s)

F13.03 (0x0D03) RUN	PID controller feedback signal source	V/F SVC 0: Keyboard digital PID feedback 1: Keyboard analog potentiometer feedback 2: Current/voltage analog AI feedback 3: Reserved 4: Reserved 5: Terminal pulse PUL feedback 6: RS485 communication feedback 7: Option card 8: Terminal selection 9: Local active current	2 (0 ~ 9)
F13.04 (0x0D04) RUN	Feedback signal low pass filtering time	V/F SVC	0.010s (0.000~6.000s)
F13.05 (0x0D05) RUN	Feedback signal gain	V/F SVC	1.00 (0.00~10.00)
F13.06 (0x0D06) RUN	Feedback signal range	V/F SVC	100.0 (0~100.0)

F13.07-F13.24: PID Adjustment

Parameter (address) djustable attribute	Name	Content	Factory default (setting range)
F13.07 (0x0D07) RUN	PID control selection	V/F SVC LED "0" digit: Feedback characteristics selection 0: Positive characteristic 1: Negative characteristic LED "00" digit: Reserved LED "000" digit: Reserved LED "0000" digit: Differential Adjustment Properties 0: Differentiate the deviation 1: Differentiate the feedback	0000 (0000 ~ 1111)
F13.08 (0x0D08) RUN	PID preset output	V/F SVC	100.0% (0.0~100.0%)
F13.09 (0x0D09) RUN	PID preset output running time	V/F SVC	0.0s (0.0~6500.0s)
F13.10 (0x0D0A) RUN	PID control deviation limit	V/F SVC	0.0% (0.0~100.0%)
F13.11 (0x0D0B) RUN	Proportional gain P1	V/F SVC	0.100 (0.000~4.000)
F13.12 (0x0D0C) RUN	Integration time I1	V/F SVC	1.0s (0.0~600.0s)
F13.13 (0x0D0D) RUN	Differential gain D1	V/F SVC	0.000s (0.000~6.000s)
F13.14 (0x0D0E) RUN	Proportional gain P2	V/F SVC	0.100 (0.000~4.000)
F13.15 (0x0D0F) RUN	Integration time I2	V/F SVC	1.0s (0.0~600.0s)
F13.16 (0x0D10) RUN	Differential gain D2	V/F SVC	0.000s (0.000~6.000s)
F13.17 (0x0D11) RUN	PID parameter switching condition	V/F SVC 0: Do not switch 1: Switch using DI terminal 2: Switch according to the deviation	0 (0 ~ 2)
F13.18 (0x0D12) RUN	Switching deviation low value	V/F SVC When the PID deviation is less than this value, the gain 1 parameter is used.	20.0% (0.0~100.0%)

F13.19 (0x0D13) RUN	Switching deviation high value	V/F SVC When the PID deviation is greater than this value, the gain 2 parameter is used.	80.0% (0.0~100.0%)
F13.20 (0x0D14) RUN	Reserved	V/F SVC	
F13.21 (0x0D15) RUN	Differential limiting	V/F SVC	5.0% (0.0~100.0%)
F13.22 (0x0D16) RUN	PID output upper limit	V/F SVC	100.0% (0.0~100.0%)
F13.23 (0x0D17) RUN	PID output lower limit	V/F SVC	0.0% (-100.0~Fb.19)
F13.24 (0x0D18) RUN	PID output filtering time	V/F SVC	0.000s (0.000~6.000s)

F13.25-F13.28: PID feedback disconnection judgment

Parameter (address) djustable attribute	Name	Content	Factory default (setting range)
F13.25 (0x0D19) STOP	Feedback disconnection action selection	V/F SVC 0: Continue PID operation without reporting failure 1: Stop and report failure 2: Continue PID operation and output alarm signal 3: Run at the current frequency, output alarm signal	0 (0 ~ 3)
F13.26 (0x0D1A) RUN	Feedback disconnection detection time	V/F SVC	1.0s (0.0~120.0s)
F13.27 (0x0D1B) RUN	Wire break alarm upper limit	V/F SVC	100.0 (0.0~100.0%)
F13.28 (0x0D1C) RUN	Wire break alarm lower limit	V/F SVC	0.0% (0.0~100.0%)

F13.29-F13.33: PID dormancy function

Parameter (address) djustable attribute	Name	Content	Factory default (setting range)
F13.29 (0x0D1D) RUN	Sleep selection	V/F SVC 0: Off 1: Valid	0 (0 ~ 1)
F13.30 (0x0D1E) RUN	Sleep frequency	V/F SVC	10.00Hz (0.00~50.00Hz)
F13.31 (0x0D1F) RUN	Sleep delay	V/F SVC	60.0S (0.0~3600.0S)
F13.32 (0x0D20) RUN	Wake up deviation	V/F SVC	5.0% (0.0~50.0%)
F13.33 (0x0D21) RUN	Wake-up delay	V/F SVC	1.0S (0.0~60.0S)

10.18 Group F14: Multi-Speed and Simple PLC

F14.00~F14.14: Multi-speed frequency given

Parameter (address) djustable attribute	Name	Content	Factory default (setting range)
---	------	---------	---------------------------------

F14.00 (0x0E00) RUN	PLC multi-speed 1	V/F SVC	10.00Hz (0.00~Maximum frequency)
F14.01 (0x0E01) RUN	PLC multi-speed 2	V/F SVC	20.00Hz (0.00~Maximum frequency)
F14.02 (0x0E02) RUN	PLC multi-speed 3	V/F SVC	30.00Hz (0.00~Maximum frequency)
F14.03 (0x0E03) RUN	PLC multi-speed 4	V/F SVC	40.00Hz (0.00~Maximum frequency)
F14.04 (0x0E04) RUN	PLC multi-speed 5	V/F SVC	50.00Hz (0.00~Maximum frequency)
F14.05 (0x0E05) RUN	PLC multi-speed 6	V/F SVC	40.00Hz (0.00~Maximum frequency)
F14.06 (0x0E06) RUN	PLC multi-speed 7	V/F SVC	30.00Hz (0.00~Maximum frequency)
F14.07 (0x0E07) RUN	PLC multi-speed 8	V/F SVC	20.00Hz (0.00~Maximum frequency)
F14.08 (0x0E08) RUN	PLC multi-speed 9	V/F SVC	10.00Hz (0.00~Maximum frequency)
F14.09 (0x0E09) RUN	PLC multi-speed 10	V/F SVC	20.00Hz (0.00~Maximum frequency)
F14.10 (0x0E0A) RUN	PLC multi-speed 11	V/F SVC	30.00Hz (0.00~Maximum frequency)
F14.11 (0x0E0B) RUN	PLC multi-speed 12	V/F SVC	40.00Hz (0.00~Maximum frequency)
F14.12 (0x0E0C) RUN	PLC multi-speed 13	V/F SVC	50.00Hz (0.00~Maximum frequency)
F14.13 (0x0E0D) RUN	PLC multi-speed 14	V/F SVC	40.00Hz (0.00~Maximum frequency)
F14.14 (0x0E0E) RUN	PLC multi-speed 15	V/F SVC	30.00Hz (0.00~Maximum frequency)

F14. 15: PLC operation mode selection

Parameter (address) adjustable attribute	Name	Content	Factory default (setting range)
F14.15 (0x0E0F) RUN	PLC operation mode selection	V/F SVC LED "0" digit: Cycle mode 0: Stop after single cycle 1: Continuous cycle 2: Keep the final value after a single cycle LED "00" digit: Timing unit 0: Second 1: Minute 2: Hour LED "000" digit: Power-down storage 0: No storage 1: Storage LED "0000" digit: Startup mode 0: Re-run from the first stage 1: Re-run from the phase of the downtime 2: Continue to run for the rest of the downtime phase	0000 (0000 ~ 2122)

F14.16~F14.30: PLC running time selection

Parameter (address) adjustable attribute	Name	Content	Factory default (setting range)
F14.16 (0x0E10) RUN	PLC first stage running time	V/F SVC	10.0 (0.0~6500.0(s/m/h))
F14.17 (0x0E11) RUN	PLC second stage running time	V/F SVC	10.0 (0.0~6500.0(s/m/h))
F14.18 (0x0E12) RUN	PLC third stage running time	V/F SVC	10.0 (0.0~6500.0(s/m/h))
F14.19 (0x0E13) RUN	PLC fourth stage running time	V/F SVC	10.0 (0.0~6500.0(s/m/h))
F14.20 (0x0E14) RUN	PLC fifth stage running time	V/F SVC	10.0 (0.0~6500.0(s/m/h))
F14.21 (0x0E15) RUN	PLC sixth stage running time	V/F SVC	10.0 (0.0~6500.0(s/m/h))
F14.22 (0x0E16) RUN	PLC seventh stage running time	V/F SVC	10.0 (0.0~6500.0(s/m/h))
F14.23 (0x0E17) RUN	PLC eighth stage running time	V/F SVC	10.0 (0.0~6500.0(s/m/h))
F14.24 (0x0E18) RUN	PLC ninth stage running time	V/F SVC	10.0 (0.0~6500.0(s/m/h))
F14.25 (0x0E19) RUN	PLC tenth stage running time	V/F SVC	10.0 (0.0~6500.0(s/m/h))
F14.26 (0x0E1A) RUN	PLC eleventh stage running time	V/F SVC	10.0 (0.0~6500.0(s/m/h))
F14.27 (0x0E1B) RUN	PLC twelfth stage running time	V/F SVC	10.0 (0.0~6500.0(s/m/h))
F14.28 (0x0E1C) RUN	PLC thirteenth stage running time	V/F SVC	10.0 (0.0~6500.0(s/m/h))
F14.29 (0x0E1D) RUN	PLC fourteenth stage running time	V/F SVC	10.0 (0.0~6500.0(s/m/h))
F14.30 (0x0E1E) RUN	PLC fifteenth stage running time	V/F SVC	10.0 (0.0~6500.0(s/m/h))

F14.31~F14.45: PLC running direction and time selection

Parameter (address) adjustable attribute	Name	Content	Factory default (setting range)
--	------	---------	---------------------------------

F14.31 (0x0E1F) RUN	PLC first direction and acceleration and deceleration time	V/F SVC LED "0" digit: The running direction of this segment (compared with the running command) 0: Same direction 1: Reverse LED "00" digit: The acceleration and deceleration time of this segment 0: Acceleration/deceleration time 1 1: Acceleration and deceleration time 2 2: Acceleration and deceleration time 3 3: Acceleration and deceleration time 4 LED "000" digit: Reserved LED "0000" digit: Reserved	0000 (0000~0031)
F14.32 (0x0E20) RUN	PLC second direction and acceleration and deceleration time	V/F SVC The same settings as F14.31	0000 (0000~0031)
F14.33 (0x0E21) RUN	PLC third direction and acceleration and deceleration time	V/F SVC The same settings as F14.31	0000 (0000~0031)
F14.34 (0x0E22) RUN	PLC fourth direction and acceleration and deceleration time	V/F SVC The same settings as F14.31	0000 (0000~0031)
F14.35 (0x0E23) RUN	PLC fifth direction and acceleration and deceleration time	V/F SVC The same settings as F14.31	0000 (0000~0031)
F14.36 (0x0E24) RUN	PLC sixth direction and acceleration and deceleration time	V/F SVC The same settings as F14.31	0000 (0000~0031)
F14.37 (0x0E25) RUN	PLC seventh direction and acceleration and deceleration time	V/F SVC The same settings as F14.31	0000 (0000~0031)
F14.38 (0x0E26) RUN	PLC eighth direction and acceleration and deceleration time	V/F SVC The same settings as F14.31	0000 (0000~0031)
F14.39 (0x0E27) RUN	PLC ninth direction and acceleration and deceleration time	V/F SVC The same settings as F14.31	0000 (0000~0031)
F14.40 (0x0E28) RUN	PLC tenth direction and acceleration and deceleration time	V/F SVC The same settings as F14.31	0000 (0000~0031)
F14.41 (0x0E29) RUN	PLC eleventh direction and acceleration and deceleration time	V/F SVC The same settings as F14.31	0000 (0000~0031)
F14.42 (0x0E2A) RUN	PLC twelfth direction and acceleration and deceleration time	V/F SVC The same settings as F14.31	0000 (0000~0031)
F14.43 (0x0E2B) RUN	PLC thirteenth direction and acceleration and deceleration time	V/F SVC The same settings as F14.31	0000 (0000~0031)
F14.44 (0x02C) RUN	PLC fourteenth direction and acceleration and deceleration time	V/F SVC The same settings as F14.31	0000 (0000~0031)
F14.45 (0x0E2D) RUN	PLC fifteenth direction and acceleration and deceleration time	V/F SVC The same settings as F14.31	0000 (0000~0031)

10.19 Group F15: Reserved

10.20 Group C0x: Monitoring Parameters

Group C00: Basic monitoring

Parameter code (address)	Name	Content	Signal level of multi-function analog output
C00.00 (0x2100)	Given frequency	V/F SVC	10V corresponds to the maximum frequency

C00.01 (0x2101)	Output frequency	V/F SVC	10V corresponds to the maximum frequency
C00.02(0x2102)	Output current	V/F SVC	10V corresponds to the rated current of the double motor (5A)
C00.03 (0x2103)	Input voltage	V/F SVC	10V corresponds to 380V
C00.04 (0x2104)	The output voltage	V/F SVC	10V corresponds to the rated voltage of the motor
C00.05 (0x2105)	Mechanical speed	V/F SVC	10V corresponds to the maximum frequency of mechanical speed
C00.06 (0x2106)	Given torque	V/F SVC	10V corresponds to +/-200%
C00.07 (0x2107)	Output torque	V/F SVC	10V corresponds to +/-200%
C00.08 (0x2108)	PID given	V/F SVC	10V corresponds to 100%
C00.09 (0x2109)	PID feedback	V/F SVC	10V corresponds to 100%
C00.10 (0x210A)	Output Power	V/F SVC	
C00.11 (0x210B)	bus voltage	V/F SVC	5V corresponding rated bus voltage
C00.12 (0x210C)	Module temperature 1	V/F SVC	10V corresponds to 100 ° C
C00.13 (0x210D)	Module temperature 2	V/F SVC	10V corresponds to 100 ° C
C00.14 (0x210E)	Input terminal X is on	V/F SVC	
C00.15 (0x210F)	Output terminal Y is on	V/F SVC	
C00.16(0x2110)	Analog AI input value	V/F SVC	10V corresponds to 10V
C00.17 (0x2111)	Reserved	V/F SVC	
C00.18 (0x2112)	Keyboard potentiometer input	V/F SVC	10V corresponds to 10V
C00.19 (0x2113)	Pulse signal PUL input value	V/F SVC	
C00.20 (0x2114)	Analog output AO	V/F SVC	
C00.21 (0x2115)	Reserved	V/F SVC	
C00.22 (0x2116)	Counter count value	V/F SVC	
C00.23 (0x2117)	Power-on running time	V/F SVC	
C00.24 (0x2118)	Accumulated running time of the	V/F SVC	
C00.25 (0x2119)	Inverter power level	V/F SVC	
C00.26 (0x211A)	Inverter rated voltage	V/F SVC	
C00.27 (0x211B)	Inverter rated current	V/F SVC	
C00.28 (0x211C)	Software version	V/F SVC	
C00.29 (0x211D)	PG feedback frequency	V/F SVC	
C00.30 (0x211E)	Timer timing	V/F SVC	
C00.31 (0x211F)	PID output value	V/F SVC	
C00.32 (0x2120)	Inverter software subversion	V/F SVC	
C00.33(0x2121)	Encoder feedback angle	V/F SVC	
C00.34 (0x2122)	Z pulse cumulative error	V/F SVC	
C00.35 (0x2123)	Z pulse count	V/F SVC	
C00.36 (0x2124)	Failure warning code	V/F SVC	
C00.37 (0x2125)	Cumulative power consumption	V/F SVC	
C00.38 (0x2126)	Cumulative power consumption	V/F SVC	
C00.39 (0x2127)	Power factor angle	V/F SVC	

C01 Group: Fault monitoring

Parameter code (address)	Name	Content
C01.00 (0x2200)	Fault type diagnostic information	V/F SVC
C01.01 (0x2201)	Troubleshooting information	V/F SVC
C01.02 (0x2202)	Fault operating frequency	V/F SVC
C01.03 (0x2203)	Fault output voltage	V/F SVC
C01.04 (0x2204)	Fault output current	V/F SVC
C01.05 (0x2205)	Fault bus voltage	V/F SVC
C01.06 (0x2206)	Faulty module temperature	V/F SVC
C01.07 (0x2207)	Faulty inverter status	V/F SVC

C01.08 (0x2208)	Fault input terminal status	V/F SVC
C01.09 (0x2209)	Fault output terminal status	V/F SVC
C01.10 (0x220A)	Previous failure type	V/F SVC
C01.11 (0x220B)	Previous troubleshooting information	V/F SVC
C01.12 (0x220C)	The first fault operation frequency	V/F SVC
C01.13 (0x220D)	Last fault output voltage	V/F SVC
C01.14 (0x220E)	Last fault output current	V/F SVC
C01.15 (0x220F)	The first fault bus voltage	V/F SVC
C01.16 (0x2210)	The first fault module temperature	V/F SVC
C01.17 (0x2211)	The first faulty inverter status	V/F SVC
C01.18 (0x2212)	The first fault input terminal status	V/F SVC
C01.19 (0x2213)	The first fault output terminal status	V/F SVC
C01.20 (0x2214)	First 2 fault types	V/F SVC
C01.21 (0x2215)	The first 2 troubleshooting information	V/F SVC
C01.22 (0x2216)	Top 3 fault types	V/F SVC
C01.23 (0x2217)	The first 3 troubleshooting information	V/F SVC

C02.0x Group: Application Monitoring

Parameter (address) adjustable attribute	Name	Content
C02.00 (0x2300)		V/F SVC PID feedback value
C02.01 (0x2301)	PID given	V/F SVC PID reference
C02.02 (0x2302)	PID output	V/F SVC PID adjustment output value
C02.03 (0x2303)	PID control status	V/F SVC PID control status
C02.04 (0x2304)	Reserved	V/F SVC
C02.05 (0x2305)	PLC operation phase	V/F SVC Current PLC running segments
C02.06 (0x2306)	PLC phase frequency	V/F SVC Current PLC given frequency
C02.07 (0x2307)	PLC phase running frequency	V/F SVC Current PLC operating frequency
C02.08(0x2308)	Positive and negative command given	V/F SVC 0: Stop command 1: Forward command 2: Reverse command
C02.09 (0x2309)	Jog command given	V/F SVC 0: no jog 1: forward jog 2: reverse jog
C02.10 (0x230A)	Reserved	V/F SVC
C02.11 (0x230B)	Reserved	V/F SVC
C02.12 (0x230C)	Reserved	V/F SVC
C02.13 (0x230D)	Reserved	V/F SVC
C02.14 (0x230E)	Reserved	V/F SVC
C02.15 (0x230F)	Reserved	V/F SVC
C02.16(0x2310)	Reserved	V/F SVC
C02.17 (0x2311)	Inverter overload count	V/F SVC Inverter overload cumulative count value
C02.18 (0x2312)	Motor overload count	V/F SVC Motor overload cumulative count value
C02.19 (0x2313)	Wave-by-wave limit	V/F SVC Monitor CBC cumulative triggers
C02.20 (0x2314)	Reserved	V/F SVC
C01.21 (0x2315)	Reserved	V/F SVC
C02.22 (0x2316)	Reserved	V/F SVC
C02.23 (0x2317)	Reserved	V/F SVC

C02.24 (0x2318)	Reserved	V/F SVC
C02.31(0x231F)	Reserved	V/F SVC
C02.32~C02.47(0x2320~ 0x231F)	Power-missing storage parameter 1 ~ power-missing storage parameter 16	V/F SVC/Use with the optional card
C02.48 (0x2330)	Reserved	V/F SVC
C02.49 (0x2331)	Reserved	V/F SVC
C02.63(0x233E)	External keyboard version	V/F SVC Thousands and hundredss are version high bytes, ten bits and ones are version low bytes
C02.63(0x233F)	Built-in keyboard version	V/F SVC Reserved

C03.0x group: maintenance monitoring

Parameter (address) adjustable attribute	Name	Content
C03.00 (0x2400)	Power-on running time (minute)	V/F SVC
C03.01 (0x2401)	The cumulative running time of the machine (hour)	V/F SVC
C03.02 (0x2403)	Reserved	V/F SVC

10.21 Communication Variable Group

MODBUS communication control group (Address 0x30xx/0x20xx)

Address	Name	Read/Wr ite	dimension (range)	Description
0x2000 /0x3000	Given frequency	R/W	0.01Hz (0.00~320.00)	Communication given frequency
0x2001 /0x3001	Command given	W	0x0000 (0x0~0x0103)	0x0000: invalid 0x0001: Forward run 0x0002: Reverse run 0x0003: Forward jog 0x0004: Reverse jog 0x0005: Deceleration stop 0x0006: Free stop 0x0007: Reset command 0x0008: Run prohibition command Communication writes 8 to 3001 address, the inverter is free to stop, need to write 9 to 3001 or power on again to run 0x0009: Run permission command 0x0101: Equivalent to F2.07 =1 [rotation parameter auto-tuning], plus run command 0x0102: Equivalent to F5.07 = 2 [static parameter auto-tuning], plus run command 0x0103: Equivalent to F5.07 = 3 [stator resistance setting], plus run command
0x2002 /0x3002	Inverter information status	R	Binary	Bit0: 0-stop 1-run Bit1: 0-non-acceleration 1-acceleration Bit2: 0-non-deceleration 1-deceleration Bit3: 0-forward 1-reverse Bit4: 0-Inverter normal 1-Faulty Bit5: 0-unlocked state 1-locked state Bit6: 0-No warning 1-Alarm
0x2003 /0x3003	Frequency conversion fault code	R	0 (0~127)	The corresponding value of the communication read fault code
0x2004/0x3004	Upper limit frequency	R/W	0.01Hz (0.00~320.00)	Communication given upper limit frequency
0x2005/0x3005	Torque setting	R/W	0.0% (0.0~100.0%)	Communication given torque setting
0x2006 /0x3006	Torque control forward speed limit	R/W	0.0% (0.0~100.0%)	Communication given torque control forward speed limit
0x2007/0x3007	Torque control reverse speed limit	R/W	0.0% (0.0~100.0%)	Communication given torque control reverse speed limit
0x2008 /0x3008	PID given	R/W	0.0% (0.0~100.0%)	Communication given PID given

0x2009 /0x3009	PID feedback	R/W	0.0% (0.0~100.0%)	Communication given PID feedback amount
0x200A/0x300A	Voltage-frequency separation voltage value setting	R/W	0.0% (0.0~100.0%)	Frequency conversion power supply application parameters
0x200E /0x300E	Acceleration time 1	R/W	0.00s (0.00~600.00s)	Read and write the value of F01.22
0x200F /0x300F	Deceleration time 1	R/W	0.00s (0.00~600.00s)	Read and write the value of F01.23
0x2010 /0x3010	Fault warning, alarm number	R	0 (0~65535)	1~127 is the fault code, 128-159 is the warning code, and 0 is the faultless code.
0x2011 /0x3011	Torque current component	R	0.0% (0.0~400.0%)	Belt special machine application parameters
0x2012 /0x3012	Torque filtering time	R/W	0.000s (0.000~6.000s)	Read and write the value of F03.47
0x2018 /0x3018	Terminal output control	W	Binary	Read and write the value output terminal function of F03.47, select F6.20~F24 to select 30 [communication control output] Bit0: Y terminal Bit1: Relay Bit2: Extend Y1 Bit3: Extended Relay
0x2019 /0x3019	AO output	W	0.01 (0~100.00)	F06.01=18[AO function output selection=communication output]
0x201B/0x301B	Custom 1	R/W	0 (0~65535)	Use with the host computer
0x201C /0x301C	Custom 2	R/W	0 (0~65535)	Use with the host computer
0x201D /0x301D	Custom 3	R/W	0 (0~65535)	Use with the host computer
0x201E /0x301E	Custom 4	R/W	0 (0~65535)	Use with the host computer
0x201F /0x301F	Custom 5	R/W	0 (0~65535)	Use with the host computer

Input and output interface communication group (address 0x34xx)

Address	Name	Read/Wr ite	dimension (range)	Description
0x3400	Extended port SPI communication mode	R	0 (0~65535)	RD05 series machine defaults to 1
0x3401	Input terminal status	R	Binary	Bit0: X1 terminal 0-OFF 1-ON Bit1: X2 terminal 0-OFF 1-ON Bit2: X3 terminal 0-OFF 1-ON Bit3: X4 terminal 0-OFF 1-ON Bit4: X5 terminal 0-OFF 1-ON Bit5: X6 terminal 0-OFF 1-ON Bit6: X7 terminal 0-OFF 1-ON Bit7: X8 terminal 0-OFF 1-ON Bit8: X9 terminal 0-OFF 1-ON Bit9: X10 terminal 0-OFF 1-ON
0x3402	Output terminal status	R	Binary	Bit0: Y terminal status 0-OFF 1-ON Bit1: Relay status 0-OFF 1-ON Bit2: Extended Y1 status 0-OFF 1-ON Bit3: Extended relay status 0-OFF 1-ON
0x3403	Reserved	R	--	--
0x3404	Reserved	R/W	--	--
0x3405	Multi-function input terminal function group 0	R	Binary	Multi-function 0~15 corresponds to one function for each function 0-OFF 1-ON
0x3406	Multi-function input terminal function group 1	R	Binary	Multi-function 16~31 corresponds to one function per function 0-OFF 1-ON
0x3407	Multi-function input terminal function group 2	R	Binary	Multi-function 32~47 each function corresponds to one bit 0-OFF 1-ON

0x3408	Multi-function input terminal function group 3	R	Binary	Multi-function 48~63 each function corresponds to one bit 0-OFF 1-ON
0x3409	Multi-function input terminal function group 4	R	Binary	Multi-function 64~79 each function corresponds to one bit 0-OFF 1-ON
0x340A	Multi-function input terminal function group 5	R	Binary	Multi-function 80~95 corresponds to one function per function 0-OFF 1-ON
0x3414	A0 function 24 output	R/W	0 (0~1000)	Use with the host computer
0x3415	A0 function 25 output	R/W	0 (0~1000)	Use with the host computer
0x3416	A0 function 26 output	R/W	0 (0~1000)	Use with the host computer
0x3417	A0 function 27 output	R/W	0 (0~1000)	Use with the host computer
0x3418	A0 function 28 output	R/W	0 (0~1000)	Use with the host computer
0x3419	A0 function 29 output	R/W	0 (0~1000)	Use with the host computer
0x341A	A0 function 30 output	R/W	0 (0~1000)	Use with the host computer
0x341B	A0 function 31 output	R/W	0 (0~1000)	Use with the host computer
0x341E	Reserved	R/W	--	--
0x341F	Reserved	R/W	--	--

Extended fault and power down parameter communication group (Address 0x36xx)

Address	Name	Read/write	dimension(range)	Description
0x3600	Custom fault number register	R/W	0 (11~18)	11~18 corresponding faults E.FA1~E.FA8
0x3601	Custom warning number register	R/W	0 (11~16)	11~16 corresponding warning A.FA1~A.FA6
0x3602	Reserved	R/W	--	--
0x3603	Reserved	R/W	--	--
0x3604	Reserved	R/W	--	--
0x3605	Reserved	R/W	--	--
0x3606	Reserved	R/W	--	--
0x3607	Reserved	R/W	--	--
0x3608	Reserved	R/W	--	--
0x3609	Reserved	R/W	--	--

11 Parameter details

11.1 Safety Precautions

Danger
Please pay attention to all the information about safety in this book. If you do not follow the warnings, you may cause death or serious injury, so please pay attention. The company will not be responsible for any damage or equipment damage caused by your company or your company's customers who fail to comply with the contents of this book.

11.2 F00 Group: Environmental Applications

The F00 group parameter [Environmental Application] is used to set the operating environment related items of the inverter.

F00.0x group: environment setting

The F00 group parameters are used to set the operating environment and operating conditions of the frequency conversion. For example, parameters access level, use selection and other items.

◇ F00.00: Parameter access level

Code (Addr.)	Name	Content	Factory setting (Setting range)
F00.00 (0x0000) RUN	Parameter access level	V/F SVC Set the parameter access level based on the case of restricted parameter access.	0 (0 ~ 3)

0: standard parameter

Accessible parameter group (Fxx group) and monitoring parameters (Cxx group)

1: Common parameters (F00.00, Pxx.yy)

Only access the parameter code set in F00.00 parameter, F00.10~F00.39 [common parameters 1~30]

2: Monitoring parameters (F00.00, Cxx.yy)

Can only access F00.00 parameters, monitoring group parameters

3: The parameter has been changed (F00.00, Hxx.yy)

Can only access F00.00 parameters, different parameters from the factory defaults

Note:

When F11.00 [key lock selection] and F11.01 [key lock password] set the lock password to the inverter, the keyboard cannot change the corresponding parameters.

◇ F00.01: Use selection

Code (Addr.)	Name	Content	Factory setting (Setting range)
F00.01 (0x0001) STOP	Use choice	V/F SVC Set the inverter for the purpose.	0 (0 ~ 1)

The inverter sets the dedicated preset settings for the purpose shown in the table below. For F00.01, the inverter will automatically set the parameters related to the application to the optimal value. The parameters to be adjusted frequently will be saved to F00.10~F00.39 [Common Parameters 1~30] for quick setting and reference.

0: general purpose machine (G type machine)

1: reserved

Note:

After setting F00.01, initialize the parameters with F00.03 = 11, 22 [Initialization = Initialization Mode 1, 2], and F00.30~F00.39 will be reset with the parameterized initialization operation.

0: general purpose machine (G type machine)

The initialization values of the following common parameter codes.

Table 11.1 Common Parameter Initialization Settings

Common parameter code	Setting parameter code	Name
F00.10	F01.00	Control method selection
F00.11	F01.01	Run command given channel
F00.12	F01.02	Frequency given channel
F00.13	F07.10	Stop mode
F00.14	F01.22	Acceleration time 1
F00.15	F01.23	Deceleration time 1
F00.16	F01.10	Maximum frequency
F00.17	F01.12	Upper limit frequency
F00.18	F01.40	Carrier frequency
F00.19	F07.30	Jog frequency
F00.20	F02.01	Number of motor poles
F00.21	F02.02	Motor rated power
F00.22	F02.03	Motor rated frequency
F00.23	F02.04	Motor rated speed
F00.24	F02.05	Motor rated voltage
F00.25	F02.06	Motor rated current
F00.26	F02.07	Motor parameter auto-tuning selection
F00.27	F12.01	ModBus address
F00.28	F12.02	Communication baud rate
F00.29	F12.03	Communication data format

The initialization values of the following common parameter codes are related to the F00.01 setting.

Table 11.2 Common Parameter Initialization Settings

Common parameter code	Setting parameter code	Name
F00.30	F07.00	Startup mode
F00.31	F07.05	Direction of rotation
F00.32	F05.02	X3 terminal function selection
F00.33	F05.03	X4 terminal function selection
F00.34	F05.04	X5 terminal function selection
F00.35	F06.01	AO output selection
F00.36	F06.00	AO output mode selection
F00.37	F06.21	Output terminal Y function selection
F00.38	F06.22	TA-TB-TC output function selection
F00.39	F04.00	V/F curve

1: Reserved

◇ F00.03: Initialization

Code (Addr.)	Name	Content	Factory setting (Setting range)
F00.03 (0x0003) STOP	Initialization	V/F SVC Set the inverter initialization method.	0 (0 ~ 33)

Note: After initialization, the value of F00.03 is automatically reset to zero.

0: not initialized

11: Initialization mode 1

Restore the parameters other than F0.01~F02.06[Motor Basic Parameters], F02.10~F02.29[Motor Advanced Parameters] and parameters that cannot be initialized, and clear the fault record value.

22: Initialization mode 2

Restoring parameters other than those that cannot be initialized and clearing the fault record value.

33: Clear the fault record

Clear all historical fault information recorded in the monitoring parameter group C01 group.

The following parameters will not be initialized even if F00.03 = 11 or 22.

Parameter code	Name
F00.10~F00.29	Common parameters 1~20
F00.01	Use choice
F07.05	Direction of rotation
F11.05	Up and down keys to quickly change the parameter code setting
F11.11~F11.18	Keyboard status interface cyclic display parameters
F11.30	RD05 serial port function selection
F12.11~F11.12	RS485 custom address setting

Note:

➤ F00.03 = 11 or 22, F00.30~F00.39 is initialized to different values with F00.01 [use selection] during initialization.

◇ F00.04: Keyboard parameter copy

Code (Addr.)	Name	Content	Factory setting (Setting range)
F00.04 (0x0004) STOP	Keyboard parameter copy	V/F SVC The parameters of the inverter can be saved to the keyboard with the keyboard and then copied to other inverters.	0 (0 ~ 33)

0: no operation

11: Upload parameters to the keyboard

The set value of the parameter is read from the inverter and saved to the keyboard.

22: Download parameters to the inverter

Copy the parameter settings saved in the keyboard to other inverters.

When the parameter is copied, its action mode will be displayed on the keyboard.

Keyboard display	Name
CoPy	Upload parameters to the keyboard
LoAd	Download parameters to the drive

When the parameter is copied, if the fault is detected, the fault will be displayed on the keyboard.

Code	Name	Reason	Countermeasures
A.CoP	Parameter copy exception alarm	Communication exception during copying	Please check or replace the keyboard cable

Note:

- Parameter copying is the uploading and downloading of all parameter groups, including motor parameters, and parameters that cannot be restored to factory values.

◇ F00.06: LCD keyboard language selection

Code (Addr.)	Name	Content	Factory setting (Setting range)
F00.06 (0x0006) RUN	LCD keyboard language selection	V/F SVC Select the display language on the LCD keyboard	0 (0 ~ 1)

Note: When the inverter is initialized by F00.03 [Initialization], the parameter setting value does not change.

0: Chinese
1: English

◇ F00.07~F00.08: Free parameter

Code (Addr.)	Name	Content	Factory setting (Setting range)
F00.07 (0x0007) RUN	Free parameter 1	V/F SVC Select the language displayed on the LCD operator.	0 (0 ~ 65535)
F00.08 (0x0008) RUN	Free parameter 2	V/F SVC When using multiple machines, it is used as the machine number.	0 (0 ~ 65535)

Note: Free parameters will not affect the operation of the inverter.

E.g:

- When using multiple machines, it is used as the machine number.
- When using multiple machines, the mode number is used for each purpose.
- Purchase, inspection, etc.

F00.1x group: common parameter settings

◇ F00.10~F00.39: Common parameters 1~30

Code (Addr.)	Name	Content	Factory setting (Setting range)
F00.10~F0 0.29 (0x000A~0x 01D) RUN	Common parameters 1~20	V/F SVC 20 common parameters can be registered in F00.10~F00.29, and the registered parameters can be quickly accessed by setting F00.00 [parameter access level].	General default parameters (0000 ~ 2999)
F00.30~F0 0.39 (0x001E~0x 027) RUN	Common parameters 21~30	V/F SVC 10 common parameters can be registered in F00.30~F00.39, and the registered parameters can be quickly accessed by setting F00.00 [parameter access level].	depending on F00.01 (0000 ~ 2999)

Note:

- F00.03 = 11 or 22, F00.30~F00.39 is initialized to different values with F00.01 [use selection] during initialization.
- Quickly access common parameters by setting F00.00=1[parameter access level=common parameters].

11.3 F01 Group: Basic Settings

F01.0x group: basic instructions

The F01.0x group parameters are used to set the control mode, the running command source, and the frequency reference source.

Control method

◇ F01.00: Control mode

Code (Addr.)	Name	Content	Factory setting (Setting range)
F01.00 (0x0100) STOP	control method	V/F SVC Select the control method according to the type and purpose of the motor used	0 (0 ~ 1)

The control method is selected according to the type and purpose of the motor used.

0: Asynchronous motor V/F control (V/F)

This control mode is used for all variable speed control that does not require fast response and precise speed control, as well as the use of multiple inverters with one frequency converter. This method is also used when the motor parameters are not clear or cannot be self-learned.

1: Asynchronous motor open loop vector control (SVC)

This control mode is used for applications requiring high speed control accuracy. It has high speed response and torque responsiveness, high torque output at low speeds.

Note:

- S/T2 models do not support open loop vector control.
- For best control results, enter the motor parameters correctly and perform motor self-learning. The F02.0x group is the basic parameter group of the motor.
- When open-loop vector control, the inverter can only drive one motor; and the inverter capacity and motor capacity can not be too different, the inverter can be two or smaller than the motor's power level, otherwise it may lead to control. Performance is degraded or the drive system is not functioning properly.

Run command source

◇ F01.01: Run command channel

Code (Addr.)	Name	Content	Factory setting (Setting range)
F01.01 (0x0101) RUN	Run command channel	V/F SVC Select the input method of the run command	0 (0 ~ 3)

0: keyboard

Use the keyboard to control the running and stopping of the inverter.

The functions of the multi-function key can be set by F11.02=1, 2, 3 [keyboard multi-function key selection = reverse, forward jog, reverse jog] to control the inversion of the frequency conversion, forward rotation, Reverse jog.

1: control circuit terminal

The inverter is controlled to run and stop through the terminals on the control board. The input method of the run command is selected by parameters. Please set F05.20 = 0~3 [terminal control operation mode = two-wire system 1, 2, three-wire system 1, 2].

2: RS485 communication

Use the RS485 communication to enter the run command.

3: Reserved

Note:

- The keyboard multi-function key switches the command channel, and selects the command channel switching mode through F11.02=4~7[keyboard multi-function key selection=keyboard and terminal, keyboard and RS485, terminal and RS485, keyboard and terminal and RS485]. The keyboard multi-function key performs command switching.
- When the terminal command is switched, the multi-function terminal function F05.0x = 48~51 [multi-function selection terminal = switch to keyboard, switch to terminal, switch to RS485, switch to optional card], the command channel can be switched.

Table 11.1 Command Input Selection Mode

Command input mode		Priority	Description
Jog	Keyboard jog	2	Valid when the command channel is running as a keyboard
	RS485 jog	2	Valid when the running command channel is RS485
	Optional card jog	2	Valid when the running command channel is an optional card
	Terminal jog	3	Valid on any channel
Run command channel		1	Set by parameter F01.01

Note: The higher the priority value is, the higher the priority would be.

Frequency given

The input method, selection and priority of the frequency command are explained.

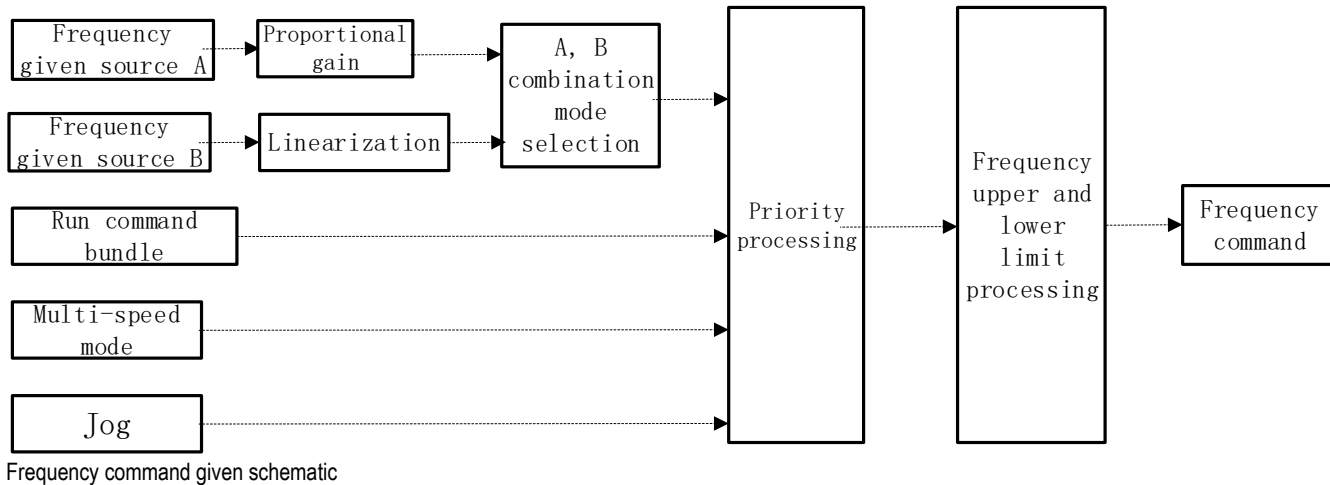

Table 11.1 Frequency Input Selection Mode

Frequency input mode		Priority	Description
Given source mode	Given source A	1	Given source A input, related parameters F01.02, F01.03
	Given source B	1	Given source B input, related parameters F01.04, F01.05, F01.06
	Given source A, B combination	1	Given the source A, B channel combination given frequency by F01.07
Run command bundled given frequency mode		2	Set the binding frequency of the command channel by F01.08
Multi-speed mode		3	Multi-function terminal set to multi-speed selection to set frequency
Jog mode		4	When the jog command is valid, the jog frequency is set by F07.30.

Note:

1. The higher the priority value, the higher the priority.
2. The multi-speed mode priority is not listed in the table above when there is no multi-speed selection in the given source mode.
3. When there is a multi-speed selection in a given source mode, the multi-speed selection mode has the same priority as the other modes in the given source.

The frequency given source A, B and the running command are bundled in the given frequency mode:

Frequency reference source input method	Description
Keyboard number setting	F01.09 set value as a given frequency
Keyboard potentiometer given	The value of the potentiometer after linearization is 0~100% corresponding to 0~maximum frequency
AI setting	AI input linearized value 0~100% corresponds to 0~maximum frequency
Terminal pulse PUL	PUL input linearized value 0~100% corresponds to 0~maximum frequency
RS485 communication	RS485 communication writes the value to the 0x3000 address to get the given frequency value.
Terminal up and down button control	Set the upper and lower key control modes and the acceleration and deceleration rate through F05.25 and F05.26.
PID control	F13 group process PID control output value 0~100% corresponds to 0~maximum frequency
Program control	The F14 group program controls the frequency set in each segment as the given frequency.
Multi-speed	The multi-terminal terminal is set to multi-speed selection to determine the frequency of the corresponding segment as a given frequency.

Note:

1. The reference value of the frequency reference source B is selected by F01.06 = 0, 1 [reference value of frequency reference source B = maximum frequency, given source B]
2. The maximum frequency is the set value of F01.10.

Multi-speed operation:

The inverter has a multi-speed operation function, and multiple frequency commands can be preset as needed. The multiple frequency command values are set in the F14.00~F14.14 parameters, and the set frequency command is selected by combining with the multi-function input signal from the outside. The required frequency command can be selected by the ON/OFF of the contact input to change the motor speed by the gear. Up to 17 speeds can be switched by the 16-speed frequency command and one jog frequency command (JOG command). The combination of multiple speed commands is shown in the table below.

Table 11.1 Combination of multiple speed command and multi-function contact input terminal

Related parameters	Multi-speed terminal 1	Multi-speed terminal 1	Multi-speed terminal 1	Multi-speed terminal 1	Multi-speed terminal 1
--------------------	------------------------	------------------------	------------------------	------------------------	------------------------

	F05.0x = 16	F05.0x = 16	F05.0x = 16	F05.0x = 16	F05.0x = 4/5
F01.09 keyboard digital setting	OFF	OFF	OFF	OFF	OFF
F14.00 multi-speed 1	ON	OFF	OFF	OFF	OFF
F14.01 multi-speed 2	OFF	ON	OFF	OFF	OFF
F14.02 multi-speed 3	ON	ON	OFF	OFF	OFF
F14.03 multi-speed 4	OFF	OFF	ON	OFF	OFF
F14.04 multi-speed 5	ON	OFF	ON	OFF	OFF
F14.05 multi-speed 6	OFF	ON	ON	OFF	OFF
F14.06 multi-speed 7	ON	ON	ON	OFF	OFF
F14.07 multi-speed 8	OFF	OFF	OFF	ON	OFF
F14.08 multi-speed 9	ON	OFF	OFF	ON	OFF
F14.09 multi-speed 10	OFF	ON	OFF	ON	OFF
F14.10 multi-speed 11	ON	ON	OFF	ON	OFF
F14.11 multi-speed 12	OFF	OFF	ON	ON	OFF
F14.12 multi-speed 13	ON	OFF	ON	ON	OFF
F14.13 multi-speed 14	OFF	ON	ON	ON	OFF
F14.14 multi-speed 15	ON	ON	ON	ON	OFF
F07.30 jog frequency	-	-	-	-	ON

◇ F01.02~F01.03: Frequency reference source A

Code (Addr.)	Name	Content	Factory setting (Setting range)
F01.02 (0x0102) RUN	Frequency reference source A	V/F SVC Select a given frequency input method	0 (0 ~ 11)
F01.03 (0x0103) STOP	Frequency reference source A gain	V/F SVC Proportional gain processing for a given source A input value	100.0% (0.0 ~ 500.0%)

Frequency given source A output mode:

- 0: Keyboard number setting
- 1: keyboard potentiometer
- 2: voltage / current analog AI given
- 3: Reserved
- 4: Reserved
- 5: terminal pulse PUL
- 6: RS485 communication
- 7: Terminal UP/DW control
- 8: PID control
- 9: Program Control (PLC)
- 10: Reserved
- 11: Multi-speed speed given

F01.04~F01.06: Frequency reference source B

Code (Addr.)	Name	Content	Factory setting (Setting range)
F01.04 (0x0102) RUN	Frequency reference source B	V/F SVC Select a given frequency input method	0 (0 ~ 11)
F01.05 (0x0103) STOP	Frequency reference source B gain	V/F SVC Proportional gain processing for a given source B input value	100.0% (0.0 ~ 500.0%)
F01.06 (0x0106) RUN	Frequency reference source B reference value	V/F SVC The source B input value is linearized and the input value is 100%.	0 (0 ~ 1)

Frequency reference source B output mode:

- 0: Keyboard number setting
- 1: keyboard potentiometer
- 2: Voltage/current analog AI given

- 3: Reserved
- 4: Reserved
- 5: terminal pulse PUL
- 6: RS485 communication
- 7: Terminal UP/DW control
- 8: PID control
- 9: Program Control (PLC)
- 10: Reserved
- 11: Multi-speed speed given

Frequency reference source B reference value:

- 0: Reference source F01.10 [maximum frequency]
- 1: Reference source is set by frequency reference source A

◇ F01.07: Frequency reference source combination selection

Code (Addr.)	Name	Content	Factory setting (Setting range)
F00.07 (0x0107) RUN	Frequency given source combination selection	V/F SVC Set the frequency given source A, B combination mode	0 (0 ~ 5)

- 0: frequency reference source A
- 1: Frequency reference source B
- 2: the sum of the frequency given source A and the frequency given source B
- 3: Difference between frequency reference source A and frequency reference source B (A-B)
- 4: Maximum value of frequency reference source A and frequency reference source B
- 5: Minimum value of frequency given source A and frequency given source B

Note:

- The value after the frequency reference source combination is limited by the upper limit frequency and the lower limit frequency.
- If F07.16 tens = 1 [running direction = only forward command is allowed] or F07.16 hundred digits = 0 [frequency control command direction = invalid], the combined calculation result is negative value with 0.00Hz as the frequency conversion The given frequency.

◇ F01.08: Run command bundled given frequency

Code (Addr.)	Name	Content	Factory setting (Setting range)
F01.08 (0x0108) RUN	Run command bundled given frequency	V/F SVC Set different running commands to bundle the given frequency mode	0x0000 (0x0000 ~ 0xCCCC)

Note: The set value is in hexadecimal notation, which is one, ten, one hundred, and one thousand. Each bit represents a different meaning.

- 0: no binding
- 1: keyboard digital setting
- 2: keyboard potentiometer
- 3: voltage / current analog AI given
- 4: Reserved
- 5: Reserved
- 6: terminal pulse PUL
- 7: RS485 communication
- 8: Terminal UP/DW control
- 9: PID control
- A: Program Control (PLC)
- B: Reserved
- C: multi-speed speed given
- Single digit: keyboard command instruction bundle
- Tens: terminal command command bundle
- Hundreds: bundle of communication command instructions
- Thousands: Optional Card Command Command Bundle

Run command bundled given frequency mode application example, using remote/local switching, remote mode using communication command setting, frequency setting, local mode using terminal command setting, keyboard digital frequency setting, only by terminal switching Command given mode, then set different channel commands to bind the given frequency mode.

◇ F01.09: Keyboard digital given frequency

Code (Addr.)	Name	Content	Factory setting (Setting range)
F01.09 (0x0109) RUN	Keyboard digital given frequency	V/F SVC Set the keyboard digital reference frequency	50.00Hz (0.00 ~ F01.10)

Note:

- This parameter is valid when F01.02=0[Frequency Reference Source A = Keyboard Digital Reference] or F01.04=0 [Frequency

Reference Source B = Keyboard Digital Reference].

F01.1x group: upper and lower limits of frequency

The F01.1x group parameter is used to set the upper and lower limits of the frequency command to limit the speed of the motor. For example, it can be used for high-speed operation due to mechanical strength, or when low-speed operation is not desired due to lubrication of gears and bearings.

The upper limit of the frequency is selected by F01.11 [upper limit frequency setting method selection], and the lower limit value is set by F01.13 [lower limit frequency].

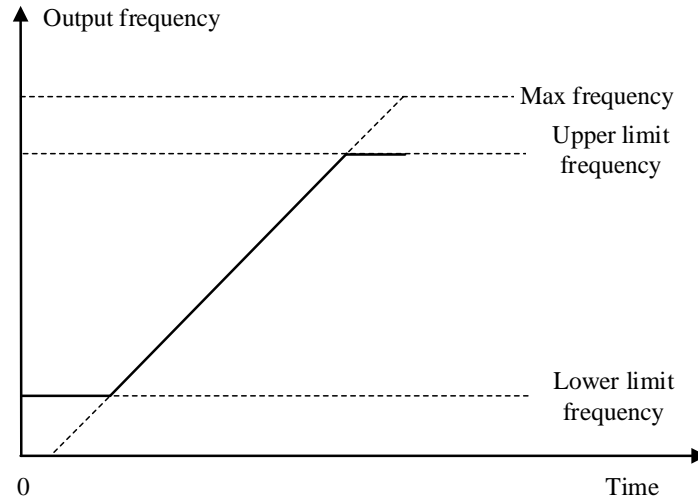

Schematic diagram of maximum frequency, upper limit frequency and lower limit frequency

◇ F00.10: Maximum frequency

Code (Addr.)	Name	Content	Factory setting (Setting range)
F01.10 (0x010A) STOP	Maximum frequency	V/F SVC Set the maximum frequency value	50.00Hz (Max frequency ~ 600.00Hz)

The maximum frequency is used as a reference corresponding to the 100.0% conversion of the analog input, pulse input (PUL), and PID control output in the inverter to the frequency;

The maximum frequency is used as the acceleration/deceleration time reference frequency (F01.20 = 0 [acceleration/deceleration time reference frequency = maximum frequency]).

◇ F01.11~F01.12: upper limit frequency

Code (Addr.)	Name	Content	Factory setting (Setting range)
F01.11 (0x010B) RUN	Upper limit frequency given mode selection	V/F SVC Upper limit frequency given mode selection	0 (0 ~ 7)
F01.12 (0x010C) RUN	Upper limit frequency digital setting	V/F SVC Set the upper frequency value	50.00Hz (下限频率 ~ F01.10)

The upper limit frequency limits the upper limit of the frequency calculated by the frequency reference source. If the calculated frequency is greater than the upper limit frequency, the upper limit frequency is given as the reference.

0: upper limit frequency digital setting

1: keyboard potentiometer

2: voltage / current analog AI given

3: Reserved

4: Reserved

5: terminal pulse PUL

6: RS485 communication

7: Reserved

◇ F01.13: lower limit frequency

Code (Addr.)	Name	Content	Factory setting (Setting range)
F01.13 (0x010D) RUN	Lower limit frequency	V/F SVC Set the lower limit frequency value	0.00Hz (0.00 ~ 上限频率)

The lower limit frequency limits the lower limit of the frequency calculated by the frequency reference source. If the calculated frequency is less than the lower limit frequency, the limit frequency is pressed as the reference.

Note:

- Jog frequency reference is not limited by the lower limit frequency.

F01.2x-F01.3x group: acceleration and deceleration time

Acceleration and deceleration time 1~4

This product can set up to 4 sets of acceleration and deceleration time. By turning ON/OFF the multi-function input terminal with acceleration/deceleration time selection 1 and acceleration/deceleration time selection 2 set, the acceleration/deceleration time can be switched even during operation.

Set the acceleration time of the output frequency from 0 Hz to the acceleration/deceleration time reference frequency. Set the output frequency from the acceleration/deceleration time reference frequency to the deceleration time of 0 Hz.

The factory setting is F01.22 [Acceleration time 1] and F01.23 [Deceleration time 1] is valid.

Select the acceleration/deceleration time reference frequency by F01.20 [Acceleration/deceleration time reference frequency selection]

F01.20 set value	Description
0	Taking the maximum frequency as the reference frequency
1	Using a fixed frequency of 50.00 Hz as the reference frequency
2	Reference frequency at a given frequency

Select the acceleration/deceleration time setting range by F01.21 [Acceleration/deceleration time unit]

Parameter	Predetermined area		
	F01.21 = 0	F01.21 = 1	F01.21 = 2
F01.22 [Acceleration time 1]	0 ~ 65000s	0.0 ~ 6500.0s	0.00 ~ 650.00s
F01.23[Deceleration time 1]			
F01.22 [Acceleration time 2]			
F01.23[Deceleration time 2]			
F01.22 [Acceleration time 3]			
F01.23[Deceleration time 3]			
F01.22 [Acceleration time 4]			
F01.23[Deceleration time 4]			

Switching the acceleration/deceleration time by the command of the multi-function input terminal

The combination of acceleration/deceleration time switching is shown in the table below.

Table 11.1 Terminal switching acceleration and deceleration time

F05.0x = 32 Acceleration/deceleration time selection 1	F05.0x = 33 Acceleration/deceleration time selection 2	Acceleration time selection	
		Acceleration time	Deceleration time
OFF	OFF	F01.22 [Acceleration time 1]	F01.23[Deceleration time 1]
ON	OFF	F01.22 [Acceleration time 2]	F01.23[Deceleration time 2]
OFF	ON	F01.22 [Acceleration time 3]	F01.23[Deceleration time 3]
ON	ON	F01.22 [Acceleration time 4]	F01.23[Deceleration time 4]

An example of the operation after changing to a longer deceleration time is shown in the figure below. In this example, F07.10 = 0 [Stop method selection = deceleration stop].

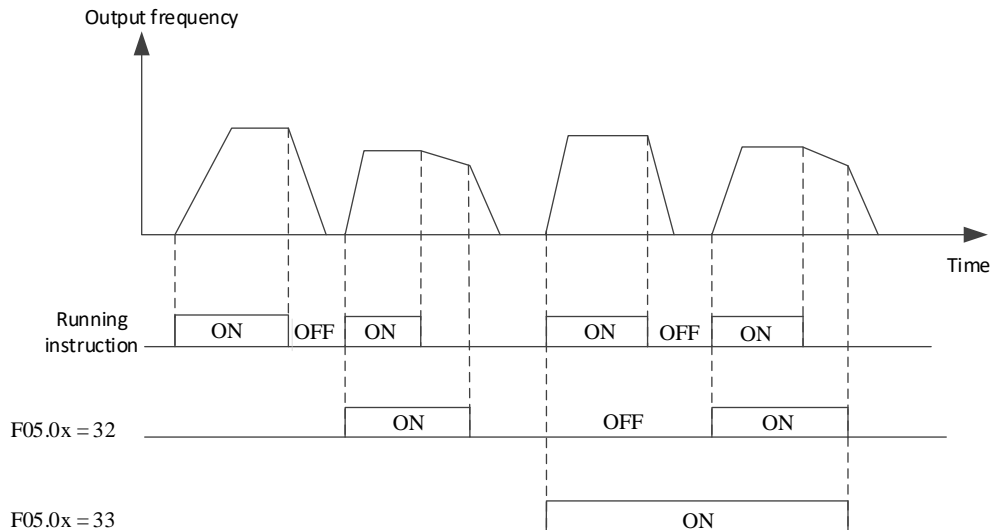

Acceleration and deceleration time timing chart

Switching acceleration and deceleration time by output frequency

The acceleration/deceleration time of the inverter can be automatically switched according to the set output frequency. When the output frequency reaches the set value of F01.35 [switching frequency of acceleration/deceleration time], the acceleration/deceleration time of the inverter will automatically switch. This function is invalid when F01.35 = 0.00 Hz.

Note:

The acceleration/deceleration time selection function set on the multi-function input takes precedence over the automatic switching function using the acceleration/deceleration time of F01.35. For example, when the multi-function input terminal with acceleration/deceleration time selection 1[F05.0x =32] is set to ON, the inverter only uses the acceleration/deceleration time 2, and the automatic switching function using the acceleration/deceleration time of F01.35 is invalid.

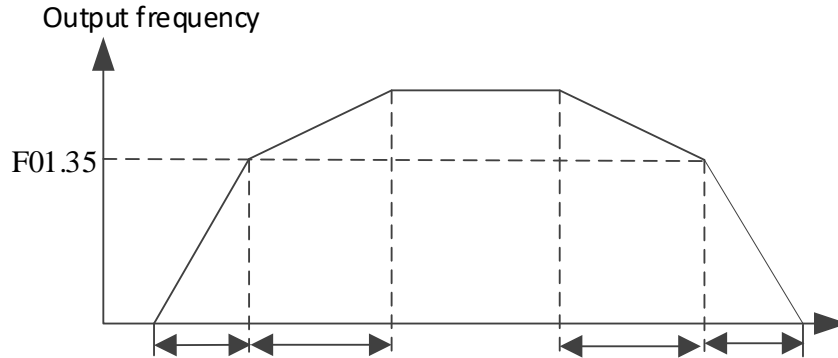

Output freq. \geq F01.35 is added and Dec. according to F01.22 & F01.23 [addition and Dec. time 1]
 Output Freq. $<$ F01.35 is added and Dec. according to F01.24 & F01.25 [addition and Dec. time 2]

Switching frequency of acceleration and deceleration time

◇ F01.20: Acceleration/deceleration time reference frequency

Code (Addr.)	Name	Content	Factory setting (Setting range)
F01.20 (0x0114) STOP	Acceleration/deceleration time reference frequency	V/F SVC Set the acceleration/deceleration time reference frequency	0 (0 ~ 3)

0: maximum frequency the reference for the acceleration/deceleration time is F01.10 [maximum frequency].

1: fixed frequency the reference for the acceleration/deceleration time is a fixed frequency of 50.00 Hz.

2: Set the frequency the reference of the acceleration/deceleration time is the set frequency. If the set frequency changes frequently, the acceleration of the motor changes, so pay attention to the application.

◇ F01.21: Acceleration/deceleration time range selection

Code (Addr.)	Name	Content	Factory setting (Setting range)
F01.21 (0x0115) STOP	Acceleration/deceleration time range selection	V/F SVC Set the decimal point of the F01.22 ~ F01.29 [Acceleration / deceleration time 1~4] parameter	2 (0 ~2)

Note: The default value is 2, which is two decimal places.

0: no decimal point

1: 1 decimal point

2: 2 decimal places

◇ F01.22: Acceleration time 1

Code (Addr.)	Name	Content	Factory setting (Setting range)
F01.22 (0x0116) RUN	Acceleration time 1	V/F SVC Set the value of acceleration time 1	With power level (Change with F01.21)

◇ F01.23: Deceleration time 1

Code (Addr.)	Name	Content	Factory setting (Setting range)
F01.23 (0x0117) RUN	Deceleration time 1	V/F SVC Set the value of deceleration time 1	With power level (Change with F01.21)

The relationship between the default value of the acceleration/deceleration time and the inverter power level is as follows.

Inverter power	Default value of acceleration/deceleration time 1~4
\leq 22KW	6.00s

<=45KW	12.00s
<=55KW	18.00s
<=75KW	24.00s
<=90KW	30.00s
<=132KW	36.00s
<=160KW	42.00s
<=185KW	48.00s
<=220KW	54.00s
Others	60.00s

◇ ▮ F01.24~F01.25 Acceleration/deceleration time 2

Code (Addr.)	Name	Content	Factory setting (Setting range)
F01.24 (0x0118) RUN	Acceleration time 2	V/F SVC Set the value of acceleration time 2	With power level (Change with F01.21)
F01.25 (0x0119) RUN	Deceleration time 2	V/F SVC Set the value of deceleration time 2	With power level (Change with F01.21)

◇ ▮ F01.26~F01.27 Acceleration/deceleration time 3

Code (Addr.)	Name	Content	Factory setting (Setting range)
F01.26 (0x011A) RUN	Acceleration time 3	V/F SVC Set the value of acceleration time 3	With power level (Change with F01.21)
F01.27 (0x011B) RUN	Deceleration time 3	V/F SVC Set the value of deceleration time 3	With power level (Change with F01.21)

◇ ▮ F01.28~F01.29 Acceleration/deceleration time 4

Code (Addr.)	Name	Content	Factory setting (Setting range)
F01.28 (0x011C) RUN	Acceleration time 4	V/F SVC Set the value of acceleration time 4	With power level (Change with F01.21)
F01.29 (0x011D) RUN	Deceleration time 4	V/F SVC Set the value of deceleration time 4	With power level (Change with F01.21)

S curve selection

The S-curve feature allows the machine to be smoothly started and stopped, reducing the impact on the load.

Set the S-curve characteristic time at the start of acceleration/deceleration and at the end of acceleration/deceleration as needed.

This function is enabled by F01.30=1[S Curve Selection=Enabled].

The S curve characteristics when running switching (forward/reverse) are as shown in the figure below.

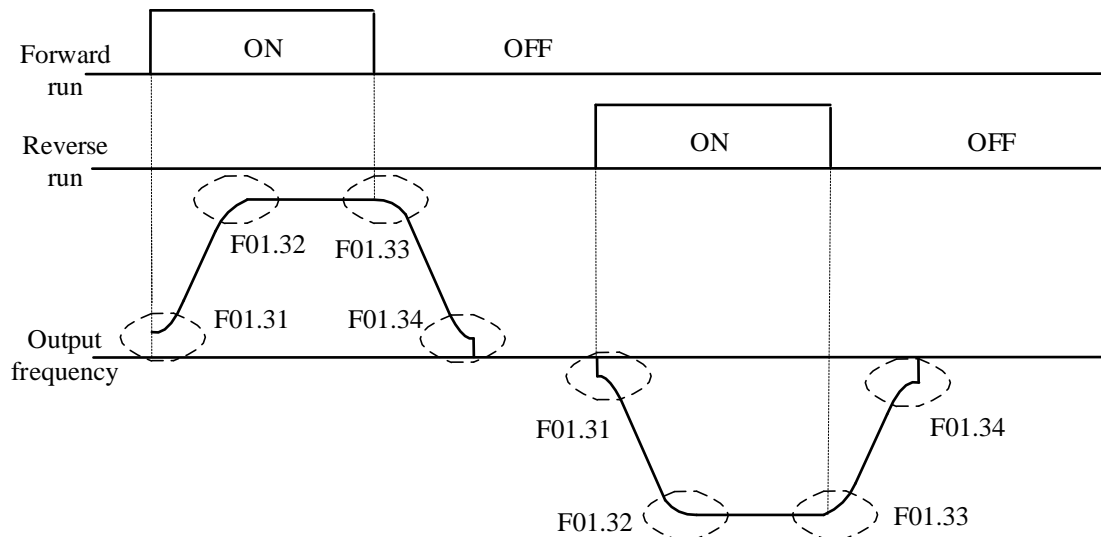

Schematic diagram of S curve

Note:

- After setting the S-curve characteristic, the acceleration/deceleration time will increase the acceleration/deceleration time as shown below.
- Acceleration time = selected acceleration time + $([F01.31]+[F01.32])/2$
- Deceleration time = selected deceleration time + $([F01.33]+[F01.34])/2$

◇ ¶ F01.30: S curve selection

Code (Addr.)	Name	Content	Factory setting (Setting range)
F01.30 (0x011E) STOP	S curve selection	V/F SVC Select whether the S curve function is on	1 (0 ~ 1)

Note: The jog S curve is set by F07.33 [Jog S curve selection].

0: invalid

1: valid

◇ ¶ F01.31: Acceleration starts S curve time

Code (Addr.)	Name	Content	Factory setting (Setting range)
F01.31 (0x011F) STOP	Acceleration start S curve time	V/F SVC Set acceleration start S curve time	0.20 (0.01 ~ 10.00s)

◇ ¶ F01.32: Accelerated end S curve time

Code (Addr.)	Name	Content	Factory setting (Setting range)
F01.32 (0x0120) STOP	Accelerated end S curve time	V/F SVC Set the acceleration end S curve time	0.20 (0.01 ~ 10.00s)

◇ ¶ F01.33: Deceleration start S curve time

Code (Addr.)	Name	Content	Factory setting (Setting range)
F01.32 (0x0121) STOP	Deceleration start S curve time	V/F SVC Set the deceleration start S curve time	0.20 (0.01 ~ 10.00s)

◇ ¶ F01.34: Deceleration end S curve time

Code (Addr.)	Name	Content	Factory setting (Setting range)
F01.34 (0x0122) STOP	Deceleration end S curve time	V/F SVC Set the deceleration end S curve time	0.20 (0.01 ~ 10.00s)

Acceleration/deceleration time switching frequency

◇ ▯ F01.35: Switching frequency of acceleration/deceleration time

Code (Addr.)	Name	Content	Factory setting (Setting range)
F01.35 (0x0123) RUN	Acceleration/deceleration time switching frequency	V/F SVC Acceleration/deceleration time switching frequency	0.00Hz (0.00 ~ F01.10)

When the output frequency reaches the set value of F01.35 [switching frequency of acceleration/deceleration time], the acceleration/deceleration time of the inverter will automatically switch, and the acceleration/deceleration time 1 will be switched to the acceleration/deceleration time 2.

Note:

- When F01.35 = 0.00 Hz, the acceleration/deceleration time is invalid with the frequency switching function.

F01.4x group: PWM control

◇ ▯ F01.40: carrier frequency

Code (Addr.)	Name	Content	Factory setting (Setting range)
F01.40 (0x0128) RUN	Carrier frequency	V/F SVC Set the switching frequency (carrier frequency) of the power transistor in the inverter.	4.0kHz (1.0 ~ 16.0kHz)

When adjusting the electromagnetic noise or reducing the noise and leakage current, please change the setting.

Note:

- The carrier defaults to 2.0 kHz during DC braking.
- The carrier defaults to 2.0 kHz during self-learning.

◇ F01.41: PWM control mode

Code (Addr.)	Name	Content	Factory setting (Setting range)
F00.05 (0x0005) RUN	PWM control mode	V/F SVC Optimize PWM control with this parameter setting	0x1111 (0x0000 ~ 0x1111)

Units: Carrier and temperature are associated

0: independent of temperature

1: related to temperature

When the inverter temperature is too high, the inverter will automatically reduce the carrier frequency; use this function to reduce the switching loss of the power device and prevent the inverter from skipping the thermal fault.

Tens: carrier is associated with output frequency

0: Independent of the output frequency

1: related to the output frequency

When the carrier and output frequency are valid, the inverter can automatically adjust the carrier frequency according to the output frequency.

This function can improve the low frequency performance of the inverter and the mute effect of high frequency.

Hundreds: reserved

Thousands: PWM modulation Select the PWM mode of the inverter

0: Only three-phase modulation is used

1: Two-phase three-phase modulation automatically switches

11.4 F02 Group: motor 1 parameters

The F02 group parameters are used to set the motor 1 parameters and motor application parameters.

F02.0x group: basic motor parameters and self-learning options

◇ ▯ F02.00: Motor type

Code (Addr.)	Name	Content	Factory setting (Setting range)
F02.00 (0x0200) READ	Motor type	V/F SVC Set the type of motor. This parameter is read only	0 (0 ~ 1)

0: asynchronous motor (AM)

1: reserved

Note:

- ▯ This parameter is a read-only parameter. F01.00 is automatically updated after F01.00 [Control Mode] is set.

◇ ▯ F02.01: Number of motor poles

Code (Addr.)	Name	Content	Factory setting (Setting range)
F02.01 (0x0201) STOP	Number of motor poles	V/F SVC Set the number of poles of the motor	4 (2 ~ 98)

◇ ¶ F02.02: rated motor power

Code (Addr.)	Name	Content	Factory setting (Setting range)
F02.02 (0x0202) STOP	Motor rated power	V/F SVC Set the rated motor power	随机型 (0.1 ~ 5.5KW)

◇ ¶ F02.03: rated motor frequency

Code (Addr.)	Name	Content	Factory setting (Setting range)
F02.03 (0x0203) STOP	Motor rated frequency	V/F SVC Set the rated frequency of the motor	50.00Hz (0.01 ~ F01.10)

◇ ¶ F02.04: rated motor speed

Code (Addr.)	Name	Content	Factory setting (Setting range)
F02.04 (0x0204) STOP	Motor rated speed	V/F SVC Set the rated motor speed	随机型 (0 ~ 65000RPM)

◇ ¶ F02.05: rated motor voltage

Code (Addr.)	Name	Content	Factory setting (Setting range)
F02.05 (0x0205)	Motor rated voltage	V/F SVC Set the rated voltage of the motor	随机型 (0 ~ 1500V)

◇ ¶ F02.06: rated motor current

Code (Addr.)	Name	Content	Factory setting (Setting range)
F02.06 (0x0206) STOP	Motor rated current	V/F SVC Set the rated current of the motor	随机型 (0.1 ~ 3000.0A)

◇ ¶ F02.07: Motor parameter auto-tuning selection

Code (Addr.)	Name	Content	Factory setting (Setting range)
F02.07 (0x0207) STOP	Motor parameter auto-tuning selection	V/F SVC Motor parameter auto-tuning selection	0 (0 ~ 3)

Note: After the parameter auto-tuning is completed, the set value of [F02.07] will be automatically set to "0". The S/T2 model does not support motor parameter auto-tuning.

0: no operation

1: Rotary self-learning

2: Static self-learning

3: stator resistance only static self-learning

◇ ¶ F02.08: Self-learning mark

Code (Addr.)	Name	Content	Factory setting (Setting range)
F02.08 (0x0208) STOP	Self-learning flag	V/F SVC	0 (0 ~ 3)

F02.1x group: asynchronous motor advanced parameters

◇ F02.10: asynchronous motor no-load current

Code (Addr.)	Name	Content	Factory setting (Setting range)
F02.10 (0x020A) STOP	Asynchronous motor no-load current	V/F SVC Set the no-load current of the asynchronous motor	Change with model (0.1 ~ 3000.0A)

◇ F02.11: Asynchronous motor stator resistance

Code (Addr.)	Name	Content	Factory setting (Setting range)
F02.11 (0x020B) STOP	Asynchronous motor stator resistance	V/F SVC Set the asynchronous motor stator resistance	Change with model (0.01mΩ ~ 60000mΩ)

Note: The decimal point is set by F02.19 digits.

◇ F02.12: Asynchronous motor rotor resistance

Code (Addr.)	Name	Content	Factory setting (Setting range)
F02.02 (0x020C) STOP	Asynchronous motor rotor resistance	V/F SVC Set the asynchronous motor rotor resistance	Change with model (0.01mΩ ~ 60000mΩ)

Note: The decimal point is set by the ten digits of F02.19.

◇ F02.13: Stator leakage inductance of asynchronous motor

Code (Addr.)	Name	Content	Factory setting (Setting range)
F02.03 (0x020D) STOP	Asynchronous motor stator leakage inductance	V/F SVC Set the stator leakage inductance of the asynchronous motor	Change with model (0.001mH ~ 6553.5mH)

Note: The decimal point is set by F02.19 hundred.

◇ F02.14: Asynchronous motor stator inductance

Code (Addr.)	Name	Content	Factory setting (Setting range)
F02.14 (0x020E) STOP	Asynchronous motor stator inductance	V/F SVC Set the stator inductance of the asynchronous motor	Change with model (0.01mH ~ 65535mH)

Note: The decimal point is set by F02.19 thousand.

◇ F02.15: stator resistance standard value

Code (Addr.)	Name	Content	Factory setting (Setting range)
F02.15 (0x020F) READ	Stator resistance standard value	V/F SVC Set the stator resistance value. This parameter is read only	Actual value conversion (0.00 ~ 50.00%)

◇ F02.16: rotor resistance standard value

Code (Addr.)	Name	Content	Factory setting (Setting range)
F02.16 (0x0210) READ	Rotor resistance standard value	V/F SVC Set the rotor resistance value. This parameter is read only	Actual value conversion (0.00 ~ 50.00%)

◇ F02.17: Stator leakage inductance value

Code (Addr.)	Name	Content	Factory setting (Setting range)
F02.17 (0x0211) READ	Stator leakage inductance	V/F SVC Set the stator leakage inductance value. This parameter is read only	Actual value conversion (0.00 ~ 50.00%)

◇ F02.18: Stator inductance standard value

Code (Addr.)	Name	Content	Factory setting (Setting range)

F02.18 (0x0212) READ	Stator inductance value	V/F SVC Set the stator inductance value. This parameter is read only	Actual value conversion (0.0 ~ 999.0%)
----------------------------	-------------------------	---	---

◇ F02.19: F02.11~F02.14 decimal point selection

Code (Addr.)	Name	Content	Factory setting (Setting range)
F02.19 (0x0213) STOP	F02.11~F02.14 decimal point selection	V/F SVC Set the decimal point of four parameters F02.11~F02.14	0x0000 (0x0000 ~ 0x2222)

Note: The default value varies with the motor power level and the factory default value does not change.

0: no decimal point

1: 1 decimal point

2: 2 decimal places

Unit digit: F02.11 parameter decimal point setting

Ten digits: F02.12 parameter decimal point setting

Hundreds place: F02.13 parameter decimal point setting

Thousands: F02.14 parameter decimal point setting

F02.2x-F02.4x Group: Reserved

F02.5x group: Motor application parameters

Stator resistance online learning

◇ F02.50: Stator resistance online learning mode

Code (Addr.)	Name	Content	Factory setting (Setting range)
F02.50 (0x0232) STOP	Stator resistance start learning function selection	V/F SVC Set the stator resistance online learning mode	Related to VFD model (0 ~ 2)

0: Invalid.

1: Only learn not to update.

Greater than 1: Learn and update. And this value limits the increment of the stator resistance that is learned each time the learning is initiated.

Note:

➤ The S/T2 model does not support auto-tuning.

➤ After the motor self-tuning is completed, the stator resistance self-learning function can be effective.

11.5 F03 Group: Vector Control

F03.0x group: speed loop (ASR)

ASR is a function that adjusts the torque command by aligning the motor speed and speed commands.

■ Before adjusting the ASR parameters

➤ Before the ASR parameter adjustment, be sure to implement self-learning to correctly set all motor parameters.

➤ Adjust the ASR parameters while the motor is connected to the load.

➤ When adjusting the ASR, you can monitor C00.01 (F11.20 bits set to 1, select the actual output frequency) and C00.06 [Motor speed], and use the analog output signal.

■ Adjustment steps when SVC control mode

The adjustment steps of the ASR parameters are as follows.

1. Run the motor at zero speed or low speed and increase F03.06 [speed loop proportional gain 2] in the range that does not cause vibration.

2. Run the motor at zero speed or low speed and lower F03.07 [speed loop integral time 2] in the range that does not cause vibration.

3. Run the motor at the set maximum speed to confirm that no vibration will occur.

4. If vibration occurs, increase the setting value of F03.07 and lower the setting value of F03.06 until the vibration no longer occurs.

5. Set the gain of the low speed range. Run the motor at zero speed or low speed and increase F03.02 [speed loop proportional gain 1] in the range that does not cause vibration.

6. The ASR proportional gain and integration time can be switched according to the output frequency. When the speed cannot be stabilized on the low speed side, set approximately 80% of the frequency at which the actual vibration occurs. When the high speed side cannot ensure the speed is stable, please set it roughly. The actual frequency of vibration is about 120%.

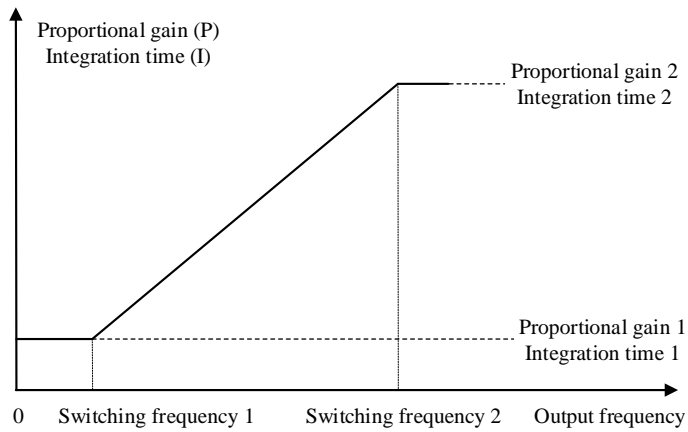

Schematic diagram of speed loop proportional gain and integration time

◇ F03.02: ASR (speed loop) proportional gain 1

Code (Addr.)	Name	Content	Factory setting (Setting range)
F03.02 (0x0302) RUN	ASR (speed loop) proportional gain 1	SVC Set ASR (speed loop) proportional gain 1	10.00 (0.01 ~ 100.00)

Increasing the gain will increase responsiveness. Generally, the larger the load, the higher the gain. However, if the gain is too large, the motor will vibrate.

◇ F03.03: ASR (speed loop) integration time 1

Code (Addr.)	Name	Content	Factory setting (Setting range)
F03.03 (0x0303) RUN	ASR (speed loop) integration time 1	SVC Set ASR (speed loop) integration time 1	0.100s (0.001 ~ 6.000s)

If the integration time is too long, the responsiveness will decrease and the ability to resist external forces will be weakened. If the integration time is too short, vibration will occur.

◇ F03.04: ASR filter time 1

Code (Addr.)	Name	Content	Factory setting (Setting range)
F03.04 (0x0304) RUN	ASR filtering time 1	SVC Set ASR filter time 1	0.0ms (0.0 ~ 100.0ms)

When the mechanical rigidity is low and it is easy to vibrate, gradually increase the set value by 0.1.

◇ F02.05: ASR switching frequency 1

Code (Addr.)	Name	Content	Factory setting (Setting range)
F03.05 (0x0305) RUN	ASR switching frequency 1	SVC Set the ASR switching frequency 1	0.00Hz (0.00 ~ F01.10)

Note: ASR control parameter selection is determined together with F03.09.

◇ F02.06: ASR (speed loop) proportional gain 2

Code (Addr.)	Name	Content	Factory setting (Setting range)
F03.06 (0x0306) RUN	ASR (speed loop) proportional gain 2	SVC Set ASR (speed loop) proportional gain 1	10.00 (0.01 ~ 100.00)

Increasing the gain will increase responsiveness. Generally, the larger the load, the higher the gain. However, if the gain is too large, the motor will vibrate.

◇ F03.07: ASR (speed loop) integration time 2

Code (Addr.)	Name	Content	Factory setting (Setting range)

F03.07 (0x0307) RUN	ASR (speed loop) integration time 2	SVC Set ASR (speed loop) integration time 1	0.100s (0.001 ~ 6.000s)
---------------------------	-------------------------------------	--	----------------------------

If the integration time is too long, the responsiveness will decrease and the ability to resist external forces will be weakened. If the integration time is too short, vibration will occur.

◇ F03.08: ASR filtering time 2

Code (Addr.)	Name	Content	Factory setting (Setting range)
F03.08 (0x0308) RUN	ASR filtering time 2	SVC Set ASR filter time 2	0.0ms (0.0 ~ 100.0ms)

When the mechanical rigidity is low and it is easy to vibrate, gradually increase the set value by 0.1.

◇ F03.09: ASR switching frequency 2

Code (Addr.)	Name	Content	Factory setting (Setting range)
F03.09 (0x0309) RUN	ASR switching frequency 2	SVC Set the ASR switching frequency 2	0.00Hz (0.00 ~ F01.10)

When the speed is not stable on the low speed side or the high speed side, the ASR proportional gain and integration time can be switched according to the output frequency.

When the set value F03.09 is greater than F03.05, the speed loop parameter is switched with the output frequency.

Output frequency	Speed loop parameter		
	Proportional gain	Integration time	Filtering time
Output frequency ≤ F03.05	F03.02	F03.03	F03.04
F03.05 < output frequency < F03.09	Linear change	Linear change	Linear change
Output frequency ≥ F03.09	F03.06	F03.07	F03.08
F03.09 = F03.05	F03.02	F03.03	F03.04

F03.1x Group: Current loop and torque limit

Set the PI parameter of the current loop during motor vector control. When vector control occurs, if speed, current oscillation, and instability occur, the gain can be appropriately reduced to achieve stability; on the contrary, increasing the gain helps to improve the dynamic response of the motor.

◇ F03.10: Current loop D-axis proportional gain

Code (Addr.)	Name	Content	Factory setting (Setting range)
F02.10 (0x030A) RUN	Current loop D-axis proportional gain	SVC Set the current loop D-axis proportional gain	1.000 (0.001 ~ 4.000)

◇ F03.11: Current loop D-axis integral gain

Code (Addr.)	Name	Content	Factory setting (Setting range)
F03.11 (0x030B) RUN	Current loop D-axis integral gain	SVC Set the current loop D-axis integral gain	1.000 (0.001 ~ 4.000)

◇ F03.12: Current loop Q-axis proportional gain

Code (Addr.)	Name	Content	Factory setting (Setting range)
F03.02 (0x030C) RUN	Current loop Q-axis proportional gain	SVC Set the current loop Q-axis proportional gain	1.000 (0.001 ~ 4.000)

◇ F03.13: Current loop Q-axis integral gain

Code (Addr.)	Name	Content	Factory setting (Setting range)
F03.03 (0x020D) RUN	Current loop Q-axis integral gain	SVC Set the current loop Q-axis integral gain	1.000 (0.001 ~ 4.000)

◇ F03.15: Motorized torque limit

Code (Addr.)	Name	Content	Factory setting (Setting range)
F03.15 (0x030F) RUN	Electric state torque limit	SVC Set the electric state torque limit	180.0% (0.0 ~ 400.0%)

Note: 100.0% corresponds to the rated torque of the motor.

◇ F03.16: Power generation torque limit

Code (Addr.)	Name	Content	Factory setting (Setting range)
F03.16 (0x0310) RUN	Power generation torque limit	SVC Set the generator state torque limit	180.0% (0.0 ~ 400.0%)

Note: 100.0% corresponds to the rated torque of the motor.

The motor torque output is also limited by the torque converted by F10.01 [Overcurrent Rejection Point] and F03.34 [Output Power Limit].

F03.2x group: torque optimization control

Asynchronous motor slip compensation

In the asynchronous machine vector control mode, when the ring vector is open, the slip compensation coefficient is used to adjust the steady speed accuracy of the motor. When the motor speed is lower than the set value after loading, the value needs to be increased, and vice versa. The range is recommended in the range: 60~160%.

◇ F03.23: Asynchronous motor slip compensation

Code (Addr.)	Name	Content	Factory setting (Setting range)
F03.23 (0x0317) RUN	Asynchronous motor slip compensation	SVC Set asynchronous motor slip compensation	100.0% (0.0~ 250.0%)

◇ F03.24: Starting torque initial value

Code (Addr.)	Name	Content	Factory setting (Setting range)
F03.24 (0x0318) RUN	Starting torque initial value	SVC Set the starting torque initial value	0.0% (0.0~ 250.0%)

F03.3x Group: Flux Optimization

Weak magnetic control

In vector control, if the motor running speed is above the rated speed, or the bus voltage is low and the motor running speed is near the rated speed, the inverter needs to weaken the motor to make the motor speed track the set speed.

F03.30~F03.31 set the weak magnetic control adjustment parameters. When there is instability in the weak magnetic process, adjust the group parameters for debugging.

Excessive weak magnetic current will cause irreversible demagnetization of the motor. In most cases, the weak magnetic current can ensure that the motor does not irreversibly demagnetize within the rated current of the motor.

◇ F03.30: Weak magnetic feedforward coefficient

Code (Addr.)	Name	Content	Factory setting (Setting range)
F03.30 (0x031E) RUN	Weak magnetic feedforward coefficient	SVC Set the weak magnetic feed forward coefficient	10.0% (0.0 ~ 200.0%)

◇ F03.31: Field weakening control gain

Code (Addr.)	Name	Content	Factory setting (Setting range)
F03.31 (0x031F) RUN	Weak magnetic control gain	SVC Set the field weakening control gain	10.0% (0.0 ~ 500.0%)

◇ F03.32: Field weakening current limit

Code (Addr.)	Name	Content	Factory setting (Setting range)

F03.32 (0x0320) RUN	Weak magnetic current upper limit	SVC Set the field weakening current limit	60.0% (0.0 ~ 250.0%)
---------------------------	-----------------------------------	--	-------------------------

Note: The set value 100.0% corresponds to the rated motor current.

◇ F03.33: Weak magnetic voltage coefficient

Code (Addr.)	Name	Content	Factory setting (Setting range)
F03.33 (0x0321) RUN	Weak magnetic voltage coefficient	SVC Set the weak magnetic voltage coefficient	97.0% (0.0 ~ 120.0%)

◇ F03.34: Output power limit

Code (Addr.)	Name	Content	Factory setting (Setting range)
F03.34 (0x0322) RUN	Output power limit	SVC Set output power limit	250.0% (0.0 ~ 400.0%)

Note: The set value 100.0% corresponds to the rated motor power.

Energy efficient operation

The asynchronous machine vector control is effective. When the energy-saving operation is performed, the output current is automatically reduced by analyzing the torque output, so that the heating loss of the motor is reduced to achieve the energy saving effect.

◇ F03.37: Energy-saving operation

Code (Addr.)	Name	Content	Factory setting (Setting range)
F03.37 (0x0325) RUN	Energy efficient operation	SVC Energy-saving operation function selection	0 (0 ~ 1)

0: off

1: on

◇ F03.38: Energy-saving operation excitation lower limit

Code (Addr.)	Name	Content	Factory setting (Setting range)
F03.38 (0x0326) RUN	Energy-saving operation excitation lower limit	SVC Set the excitation limit of energy-saving operation	50.0% (0.0 ~ 80.0%)

Note: The set value is 100.0% motor rated excitation.

◇ F03.39: Energy-saving operation filter coefficient

Code (Addr.)	Name	Content	Factory setting (Setting range)
F03.39 (0x0327) RUN	Energy-saving operating filter coefficient	SVC Set energy saving operation filter coefficient	0.010s (0.000 ~ 6.000s)

F03.4x-F03.5x Group: Torque Control

Torque command given

◇ F03.40: Torque control selection

Code (Addr.)	Name	Content	Factory setting (Setting range)
F03.40 (0x0328) RUN	Torque control selection	SVC Torque control selection	0 (0 ~ 1)

0: speed control selection

1: Torque control selection

Note:

➤ F5.0x = 60 [multi-function input terminal = switch to torque control], priority is higher than F03.40 [torque control selection].

◇ F03.41: Torque command given

Code (Addr.)	Name	Content	Factory setting (Setting range)

F03.41 (0x0329) RUN	Torque command given	SVC Set torque command given	0x0000 (0x0000 ~ 0x0566)
---------------------------	----------------------	---------------------------------	-----------------------------

Unit position: torque reference channel A

- 0: Torque digital reference
- 1: keyboard potentiometer
- 2: AI input
- 3: Reserved
- 4: Reserved
- 5: PUL input
- 6: RS485 communication given (communication address is 0x3005)

Tens place: torque reference channel B
Same as torque reference channel A setting selection

- Hundreds: Channel A, B combination
- 0: torque reference channel A
 - 1: torque reference channel B
 - 2: Torque given the sum of channel A and channel B
 - 3: Difference between torque reference channel A and channel source B (A-B)
 - 4: Maximum value of both torque reference channel A and channel B
 - 5: Minimum value of torque given channel A and channel B

Thousands: reserved

◇ F03.42: Torque digital setting

Code (Addr.)	Name	Content	Factory setting (Setting range)
F03.42 (0x032A) RUN	Torque digital setting	SVC Set torque digital setting	0.0% (0.0 ~ 100.0%)

Note:

- The set value 100% corresponds to the rated motor torque.

◇ F03.43: Torque input lower limit value

Code (Addr.)	Name	Content	Factory setting (Setting range)
F03.43 (0x032B) RUN	Torque input lower limit	SVC Set the torque input lower limit	0.00% (0.00 ~ 100.00%)

◇ ▯ F03.44: Torque lower limit corresponding setting

Code (Addr.)	Name	Content	Factory setting (Setting range)
F03.44 (0x032C) RUN	Torque lower limit corresponding setting	SVC Set the lower limit corresponding setting	0.00% (-200.00 ~ 200.00%)

Note: The set value 100% corresponds to the rated motor torque.

◇ F03.45: Torque input upper limit value

Code (Addr.)	Name	Content	Factory setting (Setting range)
F03.45 (0x032D) RUN	Torque input upper limit	SVC Set the torque input upper limit	100.00% (0.00 ~ 100.00%)

◇ F03.46: Torque upper limit setting

Code (Addr.)	Name	Content	Factory setting (Setting range)
F03.46 (0x032E) RUN	Torque upper limit setting	SVC Set the upper limit corresponding setting	100.00% (-200.00 ~ 200.00%)

Note: The set value 100% corresponds to the rated motor torque.

◇ F03.47: Torque filter time

Code (Addr.)	Name	Content	Factory setting (Setting range)
F03.47 (0x032F) RUN	Torque filtering time	SVC Set the torque reference filter time	0.100s (0.000 ~ 6.000s)

Applying filtering to the torque command signal reduces the vibration caused by the torque command signal. The interference and adjustment of the removal torque command signal is effective with the responsiveness of the command controller.
If vibration occurs using torque control, increase the set value. However, if the setting is too large, the responsiveness will deteriorate.

◇ F03.52: Maximum torque command

Code (Addr.)	Name	Content	Factory setting (Setting range)
F03.52 (0x0334) RUN	Torque command upper limit	SVC Set the upper limit of the torque command	150.0% (0.0 ~ 200.0%)

◇ F03.53: Lower torque command limit

Code (Addr.)	Name	Content	Factory setting (Setting range)
F03.53 (0x0335) RUN	Torque command lower limit	SVC Set the torque command lower limit	0.0% (0.0 ~ 200.0%)

Note: The upper and lower limits are limited after adding the absolute value to the linear processing of the torque reference command.

Speed Limit

◇ F03.54: Torque control forward speed limit selection

Code (Addr.)	Name	Content	Factory setting (Setting range)
F03.54 (0x0336) RUN	Torque control forward speed limit selection	SVC Set torque control forward speed limit selection	0 (0 ~ 7)

- 0: Forward speed limit digital setting F03.56
- 1: integrated keyboard potentiometer given × F03.56
- 2: AI × F03.56
- 3: Reserved
- 4: Reserved
- 5: PUL×F03.56
- 6: RS485 communication given (communication address is 0x3006) × F03.56
- 7: Reserved

◇ F03.55: Torque control reverse speed limit selection

Code (Addr.)	Name	Content	Factory setting (Setting range)
F03.55 (0x0337) RUN	Torque control reverse speed limit selection	SVC Set torque control reverse speed limit selection	0 (0 ~ 7)

- 0: Reverse speed limit digital setting F03.57
- 1: integrated keyboard potentiometer given × F03.57
- 2: AI × F03.57
- 3: Reserved
- 4: Reserved
- 5: PUL × F03.57
- 6: RS485 communication given (communication address is 0x3007) × F03.57
- 7: Reserved

◇ F03.56: Torque control forward speed maximum speed limit

Code (Addr.)	Name	Content	Factory setting (Setting range)
F03.56 (0x0338) RUN	Forward speed limit digital setting / gain	SVC Set forward speed limit digital setting / gain	100.0% (0.0 ~ 100.0%)

Note:
When set as the forward speed limit digital setting, the set value 100.0% corresponds to the maximum frequency.

◇ F03.57: Torque control reverse maximum speed limit

Code (Addr.)	Name	Content	Factory setting (Setting range)

F03.57 (0x0339) RUN	Reverse speed limit digital setting / gain	SVC Set reverse speed limit digital setting / gain	100.0% (0.0 ~ 100.0%)
---------------------------	--	---	--------------------------

Note:

- When the reverse speed limit digital setting is set, the set value 100.0% corresponds to the maximum frequency.

Torque reference command gain switching

When the output frequency is lower than F03.58, you could increase or decrease the given torque by setting F03.59.

- ◇ F03.58: given torque gain switching frequency

Code (Addr.)	Name	Content	Factory setting (Setting range)
F03.58 (0x033A) RUN	Given torque gain switching frequency	SVC Set the given torque gain switching frequency	2.00Hz (0.00 ~ 50.00Hz)

- ◇ F03.59: given torque gain

Code (Addr.)	Name	Content	Factory setting (Setting range)
F03.59 (0x033B) RUN	Given torque gain	SVC Set the given torque gain	100.0% (0.0 ~ 500.0%)

11.6 F04 Group: V/F Control

F04.0x Group: V/F control

V/F pressure frequency curve

- ◇ F04.00: VF curve selection

Code (Addr.)	Name	Content	Factory setting (Setting range)
F04.00 (0x0400) STOP	VF curve selection	V/F Set the VF curve	0 (0 ~ 11)

0: straight line VF curve

1-9: respectively, the torque curve of the power of 1.1-1.9 VF

10: square VF curve

11: Custom VF curve

Note:

- F04.00 = 11 [VF curve selection = custom VF curve], set by F04.0x.
- The straight line and the torque reduction curve are as follows. The torque reduction VF curve is valid above 0.3 times the rated motor frequency.

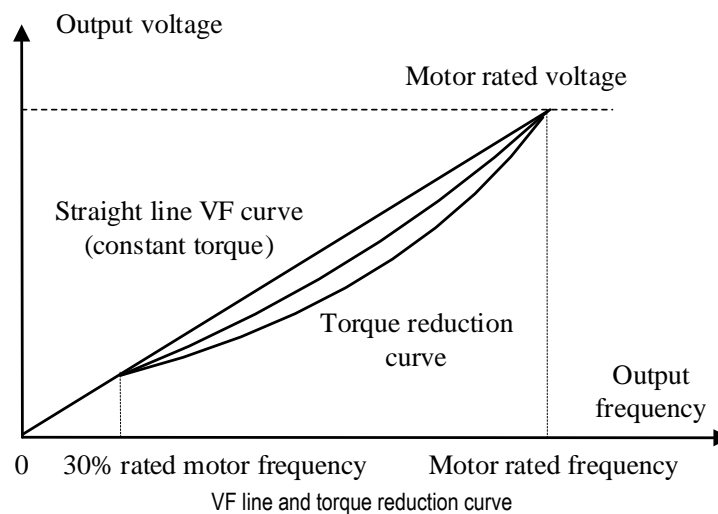

Torque boost

- ◇ F04.01: Torque boost

Code (Addr.)	Name	Content	Factory setting (Setting range)

F04.01 (0x0401) RUN	Torque boost	V/F Set torque boost	随机型 (0.0 ~ 30.0%)
---------------------------	--------------	-------------------------	----------------------

0.0: Automatic torque boost to compensate for losses on the stator resistance.

Other values: fixed torque boost

Note:

- When F04.01 = 0.0 [torque boost = automatic torque boost], the accurate stator resistance value is obtained by F02.07=3 self-learning, but the motor output is in the best state.
- The schematic diagram of the fixed torque boost under the V/F curve line and curve is as follows.

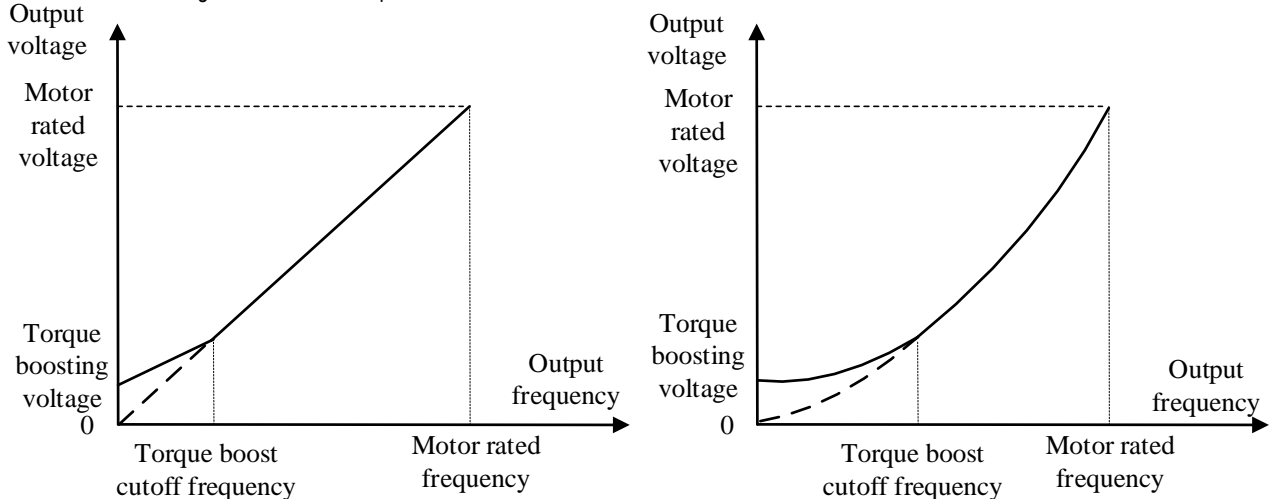

Fixed torque lifting diagram

◇ F04.02: Torque boost cutoff frequency

Code (Addr.)	Name	Content	Factory setting (Setting range)
F04.02 (0x0402) RUN	Torque boost cutoff frequency	V/F Set the torque boost cutoff frequency	100.0% (0.0 ~ 100.0%)

Note: The default value of 100% corresponds to the rated motor frequency.

Slip compensation

This function can make the output frequency of the inverter automatically adjust within the set range with the change of the motor load; dynamically compensate the motor's slip frequency, so that the motor basically maintains a constant speed, effectively reducing the impact of load changes on the motor speed.

◇ F04.03: slip compensation gain

Code (Addr.)	Name	Content	Factory setting (Setting range)
F04.03 (0x0403) RUN	Slip compensation gain	V/F Set the slip compensation gain	0.0% (0.0 ~ 100.0%)

◇ F04.04: slip compensation limiter

Code (Addr.)	Name	Content	Factory setting (Setting range)
F04.04 (0x0404) RUN	Slip compensation limit	V/F Set slip compensation limit	100.0% (0.0 ~ 300.0%)

Note: The parameter setting value 100% corresponds to the rated slip frequency.

◇ F04.05: slip compensation filter time

Code (Addr.)	Name	Content	Factory setting (Setting range)
F04.05 (0x0405) RUN	Slip compensation filter time	V/F Set the slip compensation filter time	0.200s (0.000 ~ 6.000s)

Oscillation suppression

In the medium and high power motor applications, the motor current is unstable and the motor speed oscillates. This is a kind of low frequency resonance generated by the interaction of electrical and mechanical. The vibration of small power motors is generally not obvious. By adjusting F04.06 and F04.07, the low-frequency resonance can be suppressed, and the oscillation suppression gain value can be gradually increased

on the premise of stability.

✧ ¶ F04.06: Oscillation suppression gain

Code (Addr.)	Name	Content	Factory setting (Setting range)
F04.06 (0x0406) RUN	Oscillation suppression gain	V/F Set the oscillation suppression gain	100.0% (0.0 ~ 900.0%)

✧ ¶ F04.07: Oscillation suppression filter time

Code (Addr.)	Name	Content	Factory setting (Setting range)
F04.07 (0x0407) RUN	Oscillation suppression filter time	V/F Set the oscillation suppression filter time	1.0 (0.0 ~ 100.0s)

VF output voltage ratio

✧ ¶ F04.08: Output voltage percentage

Code (Addr.)	Name	Content	Factory setting (Setting range)
F04.08 (0x0408) STOP	Output voltage percentage	V/F Set the output voltage percentage	100.0% (25.0 ~ 120.0%)

This parameter adjusts the percentage/gain of the output voltage during VF control.

F04.1x group: Custom V/F curve

This product provides 5 stages of settable voltage-to-frequency ratio to meet the needs of various motors for different voltage-to-frequency ratios.

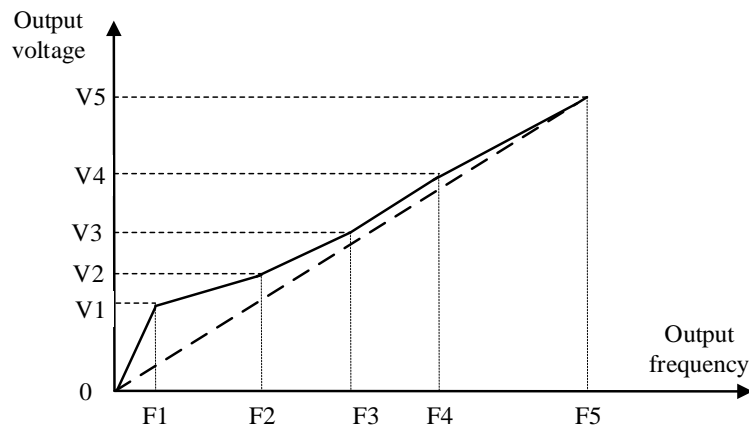

Custom curve diagram

✧ ¶ F04.10: Self-setting voltage 1

Code (Addr.)	Name	Content	Factory setting (Setting range)
F04.10 (0x040A) STOP	Self-setting voltage 1	V/F Set the self-set voltage 1. The set value 100.0% corresponds to the rated voltage of the motor	3.0% (0.0 ~ 100.0%)

✧ ¶ F04.11: Self-set frequency 1

Code (Addr.)	Name	Content	Factory setting (Setting range)
F04.11 (0x040B) STOP	Self-set frequency 1	V/F Set the self-set frequency 1	1.00Hz (0.00~ F01.10)

✧ ¶ F04.12: Self-setting voltage 2

Code (Addr.)	Name	Content	Factory setting (Setting range)
F04.02 (0x040C) STOP	Self-setting voltage 2	V/F Set the self-set voltage 2. The set value 100.0% corresponds to the rated voltage of the motor	28.0% (0.0 ~ 100.0%)

✧ ¶ F04.13: Self-set frequency 2

Code (Addr.)	Name	Content	Factory setting (Setting range)
F04.03 (0x040D) STOP	Self-set frequency 2	V/F Set the self-set frequency 2	10.00Hz (0.00~ F01.10)

✧ ¶ F04.14: Self-setting voltage 3

Code (Addr.)	Name	Content	Factory setting (Setting range)
F04.14 (0x040E) STOP	Self-setting voltage 3	V/F Set the self-setting voltage 3. The set value 100.0% corresponds to the rated voltage of the motor	55.0% (0.0 ~ 100.0%)

✧ ¶ F04.15: Self-set frequency 3

Code (Addr.)	Name	Content	Factory setting (Setting range)
F04.15 (0x040F) STOP	Self-set frequency 3	V/F Set the self-set frequency 3	25.00Hz (0.00~ F01.10)

✧ ¶ F04.16: Self-setting voltage 4

Code (Addr.)	Name	Content	Factory setting (Setting range)
F04.16 (0x0410) STOP	Self-setting voltage 4	V/F Set the self-set voltage 4. The set value 100.0% corresponds to the rated voltage of the motor	78.0% (0.0 ~ 100.0%)

✧ ¶ F04.17: Self-set frequency 4

Code (Addr.)	Name	Content	Factory setting (Setting range)
F04.17 (0x0411) STOP	Self-set frequency 4	V/F Set the self-set frequency 4	37.50Hz (0.00~ F01.10)

✧ ¶ F04.18: Self-setting voltage 5

Code (Addr.)	Name	Content	Factory setting (Setting range)
F04.18 (0x0412) STOP	Self-setting voltage 5	V/F Set the self-set voltage to 5. The set value 100.0% corresponds to the rated voltage of the motor	100.0% (0.0 ~ 100.0%)

✧ ¶ F04.19: Self-set frequency 5

Code (Addr.)	Name	Content	Factory setting (Setting range)
F04.19 (0x0413) STOP	Self-set frequency 5	V/F Set the self-set frequency 5	50.00Hz (0.00~ F01.10)

F04.2x Group: Reserved

F04.3x Group: V/F energy saving control

When the motor is under light load, the inverter automatically adjusts the output voltage after entering the constant speed to improve the efficiency of the motor and achieve energy saving.

✧ ¶ F04.30: Automatic energy saving control

Code (Addr.)	Name	Content	Factory setting (Setting range)
F04.30 (0x041E) STOP	Automatic energy saving control	V/F Select whether automatic energy saving control is on	0 (0 ~ 1)

0: off
1: on

◇ ▮ F04.31: Energy saving buck frequency lower limit

Code (Addr.)	Name	Content	Factory setting (Setting range)
F04.31 (0x041F) STOP	Energy saving step frequency lower limit	V/F Set the lower limit of energy saving buck frequency	15.00Hz (0.00 ~ 50.00Hz)

Note: When the inverter output frequency is lower than this value, the automatic energy saving control will exit. 100% corresponds to the rated frequency of the motor.

◇ ▮ F04.32: Energy saving step-down voltage lower limit

Code (Addr.)	Name	Content	Factory setting (Setting range)
F04.32 (0x0420) STOP	Energy-saving step-down voltage lower limit	V/F Set the energy-saving step-down voltage lower limit	50.0% (0.0 ~ 100.0%)

Note: The set value 100.0% is the output voltage corresponding to the current output frequency when there is no energy saving control.

◇ ▮ F04.33: Energy-saving step-down voltage regulation rate

Code (Addr.)	Name	Content	Factory setting (Setting range)
F03.33 (0x0321) RUN	Energy-saving step-down voltage regulation rate	V/F Set the energy-saving step-down voltage regulation rate.	0.010V/ms (0.0 ~ 0.200V/ms)

◇ ▮ F04.34: Energy-saving voltage and voltage recovery rate

Code (Addr.)	Name	Content	Factory setting (Setting range)
F04.34 (0x0422) RUN	Energy-saving voltage and voltage recovery rate	V/F Set the energy saving voltage and voltage recovery rate.	0.200V/ms (0.000 ~ 2.000V/ms)

11.7 F05 Group: Input terminal

F05.0x group: Digital input terminal (X1-X4)

Function selection of terminals X1 ~ X4

The RD05 inverter comes with 4 (X1~X4) multi-function input terminals, which cannot be extended by IO. The factory-set functions are shown in the table below.

Code	Name	Factory setting	Features
F05.00	Terminal X1 function selection	1	Forward run command (2-wire control)
F05.01	Terminal X2 function selection	2	Reverse run command (2-wire control)
F05.02	Terminal X3 function selection	4	Forward turn
F05.03	Terminal X4 function selection	8	Fault reset

Refer to the table below to set the function of F05.0x [Function selection of multi-function input terminal].

Set value	Functions	Set value	Functions
0	No function	40	Timer trigger terminal
1	Forward running	41	Timer clear terminal
2	Reverse run	42	Counter clock input terminal
3	Three-wire operation control (Xi)	43	Counter clear terminal
4	Forward turn	44	DC brake command
5	Reverse jog	45	Pre-excitation command terminal
6	Free parking	46	Reserved
7	Emergency pull over	47	Reserved
8	Fault reset	48	Command channel switch to keyboard
9	External fault input	49	Command channel switch to terminal
10	Frequency increment (UP)	50	Command channel switch to communication
11	Frequency decrement (DW)	51	Command channel switch to expansion card

12	Frequency increment decrement clear (UP/DW clear)	52	Run prohibition
13	Channel A switches to channel B	53	Forward prohibition
14	Switch the frequency channel combination to A	54	Reverse prohibition
15	Switch the frequency channel combination to B	55	Reserved
16	Multi-speed terminal 1	56	Reserved
17	Multi-speed terminal 2	57	Zero servo command
18	Multi-speed terminal 3	58	Run output blocking command
19	Multi-speed terminal 4	59	Reserved
20	PID control canceled	60	Speed torque control switching
21	PID control pause	61	Reserved
22	PID characteristic switching	62	Reserved
23	PID parameter switching	63	Reserved
24	PID given switch 1	64	Reserved
25	PID given switch 2	65	Reserved
26	PID given switch 3	66	Reserved
27	PID feedback switching 1	67	Reserved
28	PID feedback switching 2	68	Reserved
29	PID feedback switching 3	69	Reserved
30	Program run (PLC) pause	70	Reserved
31	Program run (PLC) restart	71	Reserved
32	Acceleration/deceleration time selection terminal 1	72	Reserved
33	Acceleration/deceleration time selection terminal 2	73	Reserved
34	Suspension acceleration	74	Reserved
35	Swing frequency input	75	Reserved
36	Swing frequency pause	76	Reserved
37	Swing frequency reset	77	Reserved
38	Keyboard button and display self-test selection	78	Reserved
39	X4 frequency measurement	79	Reserved

✧ ¶ F05.00: Terminal X1 function selection

Code (Addr.)	Name	Content	Factory setting (Setting range)
F05.00 (0x0500) STOP	Terminal X1 function selection	V/F SVC Set the function assigned to the multi-function input terminal X1	1 (0 ~ 95)

✧ ¶ F05.01: Terminal X2 function selection

Code (Addr.)	Name	Content	Factory setting (Setting range)
F05.01 (0x0501) STOP	Terminal X2 function selection	V/F SVC Set the function assigned to the multi-function input terminal X2	2 (0 ~ 95)

✧ ¶ F05.02: Terminal X3 function selection

Code (Addr.)	Name	Content	Factory setting (Setting range)
F05.02 (0x0502) STOP	Terminal X3 function selection	V/F SVC Set the function assigned to the multi-function input terminal X3	4 (0 ~ 95)

✧ ¶ F05.03: Terminal X4 function selection

Code (Addr.)	Name	Content	Factory setting (Setting range)
F05.03 (0x0503) STOP	Terminal X4 function selection	V/F SVC Set the function assigned to the multi-function input terminal X4	8 (0 ~ 95)

Multi-function input setting value

Set the function assigned to F05.00~F05.03.

0: no function

Indicates that the terminal is invalid. If the terminal function is idle, it is recommended to set it to "0" to prevent misoperation.

1: Forward running

When the running command is given by the terminal, if the parameter F05.20 [terminal control mode] is set to "0: two-wire system 1", the inverter will run in the forward direction when the terminal is valid. For other control modes, see F05.20. [Terminal control mode]; Start protection feature reference parameter F07.03 [Start protection selection].

2: Reverse running

When the running command is given by the terminal, if F05.20 [terminal control mode] is set to "0: two-wire system 1", the inverter will run in reverse when the terminal is valid. For other control modes, see F05.20 [Terminal control mode]; Start protection feature reference parameter F07.03 [Start protection selection].

3: Three-wire operation control (Xi)

When the running command is given by the terminal, if F05.20 [terminal control mode] is set to "2(3): three-wire system 1 (2)", the terminal is the three-wire operation control terminal (Xi). For details, see F05.20 [Terminal Control Mode]; At the same time, the startup protection feature is invalid. For details, see parameter F07.03 [Startup Protection Selection].

4: Forward turn

5: Reverse jog

Positive and negative jog command input port. When this terminal is valid, the inverter will jog. The terminal jog command has the highest priority. For detailed setting of jog parameters, see F07.3x [Jog Parameter Group]; jog protection characteristics refer to parameter F07.03 [Start Protection Selection].

6: Free parking

When the terminal is valid, the inverter immediately blocks the output, and the motor is in free running state.

When the free stop terminal is always active, the drive will not accept any start command and remain stopped.

When the keyboard, RS485, optional card and terminal three-wire control are running, after the free stop terminal command is released, the original operation command will not be restored. If the inverter needs to be started, the operation command must be re-entered.

7: Emergency stop

If an emergency stop command is input during the operation of the inverter, the inverter will decelerate to a stop with the deceleration time set by F05.27 [Terminal emergency stop deceleration time].

After entering the emergency stop command, it cannot be re-run until the inverter has completely stopped. If F07.10 [Stop Mode] is set to Free Stop, the inverter will still perform emergency stop deceleration according to the emergency stop time.

When the emergency stop terminal is always active, the inverter will not accept any start command and keep the stop command status. When the terminal two-wire control is running, whether the original running command is restored after the emergency stop terminal command is released, see parameter F07.03 [Startup protection selection].

When the keyboard, communication, optional card and terminal three-wire control are running, the original stop command is not restored after the emergency stop terminal command is released. To start the drive, you need to re-enter the run command.

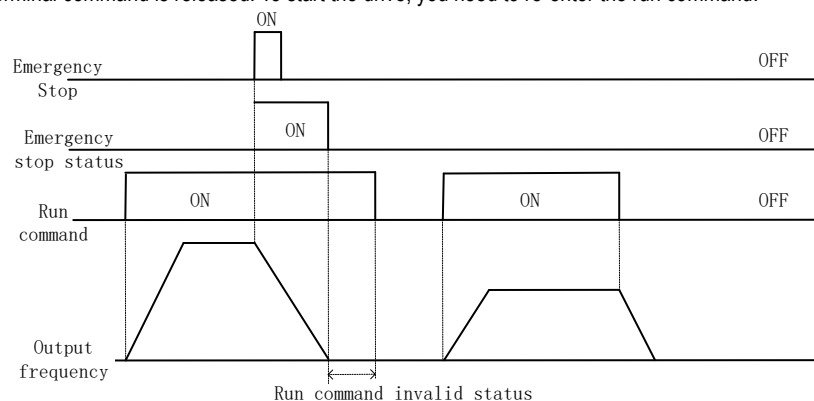

Emergency stop command diagram

Note: Sudden deceleration may cause the inverter to generate an overvoltage fault. When an overvoltage fault occurs, the output of the inverter will be cut off and the motor will run freely, which will cause the motor to be out of control. Therefore, when using the emergency stop function, set the appropriate deceleration time in F05.27 [Terminal emergency stop deceleration time] or use it with the energy consumption brake function.

8: Fault reset

When the inverter has a fault alarm, the fault can be reset through this terminal. When the two-wire control of the terminal is running, whether the original operation command is restored after the fault is reset, refer to parameter F07.03 [Startup protection selection] setting value.

9: External fault input

Through this terminal, the fault signal of the external device can be input, which is convenient for the inverter to monitor and protect the fault of the external device. After the inverter receives the external fault input signal, it immediately blocks the output, the motor is in free running state, and the fault information E. EF is displayed.

10: Frequency increment (UP)

11: Frequency decrement (DW)

The increment (UP) and decrement (DW) of a given frequency are achieved by the control terminals. Only valid when parameter F01.02 [Frequency reference source channel A] is set to "7" terminal UP/DW control.

The memory and clear mode after UP and DW adjustment frequency can be set by F05.25 [Terminal UP/DW control selection]. For details, see F05.25 [Terminal UP/DW Control Selection] parameter description;

The F05.26 [terminal UP/DW control frequency increase/deceleration rate] setting terminal UP/DW can be used to control the acceleration/deceleration rate of the given frequency. For details, see F05.26 [terminal UP/DW control frequency increase/deceleration rate] parameter description.

12: Frequency increment decrement clear (UP/DW clear)

UP, DW adjustment frequency can be cleared at any given time by the "frequency increment decrement clear (UP / DW clear)" terminal to clear its given frequency.

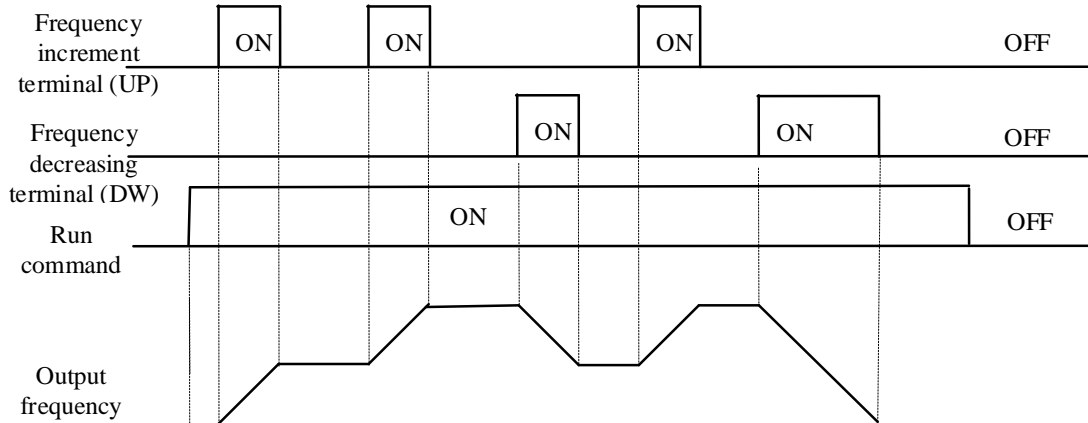

Terminal increase or decrease frequency diagram

13: Channel A switches to channel B

14: Frequency channel combination is switched to channel A

15: Frequency channel combination is switched to B

The frequency is given to the fixed channel combination through the terminal.

16: multi-speed terminal 1

17: Multi-speed terminal 2

18: Multi-speed terminal 3

19: Multi-speed terminal 4

The input port of the multi-speed command, the coding combination realizes 15 speeds; the multi-speed command has priority next to the jog command.

20: PID control canceled

When the terminal is valid, the process PID function can be disabled, the PID output and internal state are forcibly cleared. When the terminal is invalid, the PID restarts calculation.

21: PID control is suspended

When the terminal is valid, the process PID function can be suspended, and the PID output and internal state maintain the current value. When the terminal is invalid, the PID continues to operate based on the current value.

22: PID feature switching

When this terminal is valid, the PID feedback characteristic of the bit setting of parameter F13.07 [PID Control Select] will change. When the terminal is invalid, the PID output characteristic will be changed to the ones of F13.07 [PID Control Select]. Set the PID feedback characteristics.

23: PID parameter switching

This terminal selection is valid when F13.17 [PID Parameter Switching Condition] is set to "1". When this function is invalid, the PID adjustment ratio, integral, and derivative parameters are F13.11~F13.13 [proportional, integral, and derivative parameters1], and when valid, it is F13.14~F13.16 [proportional, integral, and differential parameter 1].

24: PID given switch 1

25: PID given switch 2

26: PID given switch 3

When F13.00 [PID controller given signal source] is set to "8" terminal selection, the channel of the PID controller given signal source is switched through this group terminal. For details, see F13.00 [PID controller given signal] Source] parameter description.

27: PID feedback switch 1

28: PID feedback switch 2

29: PID feedback switch 3

When F13.03 [PID Controller Feedback Signal Source] is set to "8" terminal selection, the channel of the PID controller feedback signal source is switched through this group terminal. For details, see F13.03 [PID Controller Feedback Signal Source] Parameters. Description.

30: Program operation (PLC) is suspended

When F01.02 [Frequency Reference Source Channel A] is set to "9: Program Control (PLC) Reference", during the running of the program, this signal is valid to suspend the program operation and the inverter runs at the current segment frequency. After the signal disappears, it will continue to run according to the state before the pause. For detailed parameters of the program control (PLC), refer to the detailed description of the "F14" group parameters [multi-speed and PLC function].

31: Program operation (PLC) restart

When F01.02 [Frequency Reference Source Channel A] is set to "9: Program Control (PLC) Reference", this signal is valid to restart the program during the stop status and program operation. The phase begins to run. For detailed parameters of the program control (PLC), refer

to the detailed description of the "F14" group parameters [multi-speed and PLC function].

32: Acceleration/deceleration time selection terminal 1

33: Acceleration/deceleration time selection terminal 2

The acceleration/deceleration time selects the command input port, and the coding combination realizes the selection of the 4-stage acceleration/deceleration. When the parameter is not set and the terminal is invalid, the default selection is that the acceleration/deceleration time 1 is valid. See the detailed description of parameters F01.24~F01.29 [addition and deceleration time 2, 3, 4] for details.

34: Acceleration/deceleration pause In the inverter running state, when the terminal is valid, the inverter stops acceleration and deceleration and keeps the current speed unchanged.

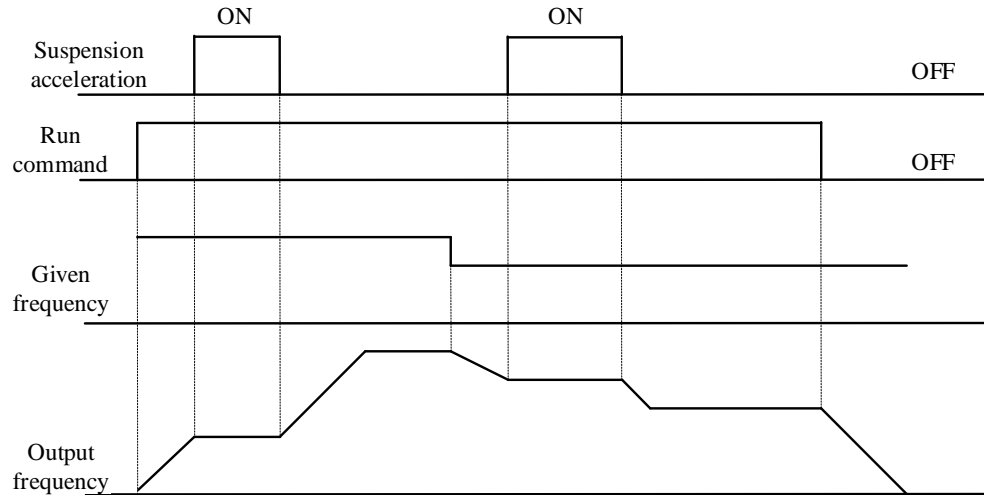

Acceleration and deceleration pause

35: Swing frequency input

In the swing frequency control, if it is set to manual input, when the terminal is valid, the swing frequency function is valid, and the inverter starts the swing frequency operation. See parameter F08.3x [Wobble Frequency Control Parameter Group] for details.

36: swing frequency pause

During the swing frequency control, when the terminal is valid, the inverter keeps the current output frequency unchanged. After the terminal command is cancelled, the swing frequency operation is resumed. See parameter F08.3x [Wobble Frequency Control Parameter Group] for details.

37: swing frequency reset

During swing frequency control, when the terminal generates a valid edge delay (invalid to active state), the inverter first returns to the center frequency and then re-enters the swing frequency operation. See parameter F08.3x [Wobble Frequency Control Parameter Group] for details.

38: keyboard self-test

When the input port is valid, the keyboard enters the self-test interface.

39: Frequency selection

The X4 terminal function on the control panel is changed to a high-speed pulse port, which is used as a PUL input port.

40: Timer trigger terminal

The port that starts the timer to start the timer operation, and triggers the timing when the terminal is valid. See parameter F08.07 [Timer Time Unit] and F08.08 [Timer Set Value] for details.

41: Timer clear terminal

The timing record of the timer is cleared when the terminal is valid. See parameter F08.07 [Timer Time Unit] and F08.08 [Timer Set Value] for details.

42: Counter clock input terminal

For the clock input terminal of the counter function, see parameter F08.02 [Counter Maximum] and F08.03 [Counter Set Value].

43: Counter clear terminal

When the terminal is valid, the count record of the counter is cleared. For details, see parameter F08.02 [Counter Maximum] and F08.03 [Counter Set Value].

44: DC braking command

When the inverter is stopped, the DC braking function of the inverter can be started. For the current during DC braking, refer to parameter F07.23 [DC Brake Current] setting value. If a run or jog command is input, the DC brake will be released.

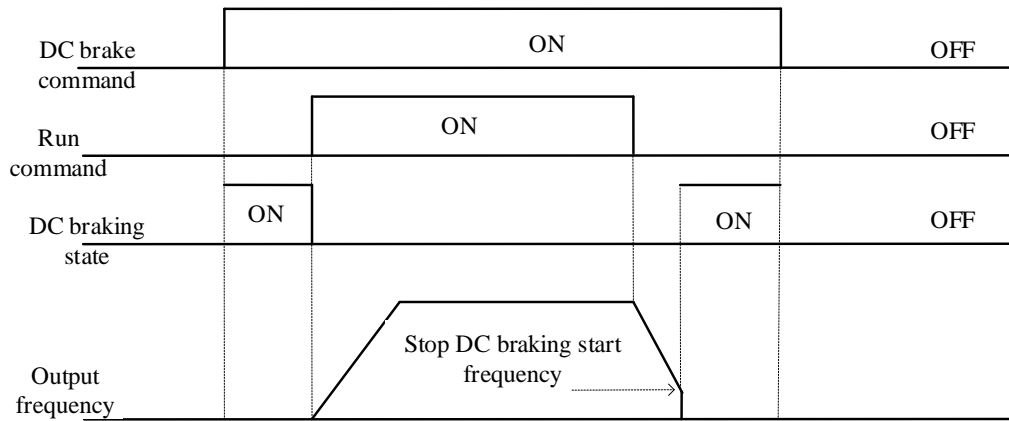

DC braking command diagram

45: Pre-excitation command terminal

This function is only valid during asynchronous machine vector control. When the inverter is stopped, the pre-excitation function of the inverter can be started. If a run or jog command is input, the pre-excitation will be released.

46-47: Reserved

48: Command channel switches to keyboard

49: Command channel is switched to the terminal

50: Command channel switches to communication

51: Command channel switch to expansion card

The command channel switching terminal can be switched to four kinds of command settings, and the effective priority of the terminal is from keyboard to terminal, communication, and expansion card from high to low.

Note: When both command channel terminals are valid at the same time, the command channel is selected as the keyboard by default.

52: Run prohibition

53: Forward transfer prohibition

54: Reverse prohibition

When the operation prohibition terminal selection is valid, the running command in the stop state is invalid, and the running state is free to stop;

When the forward rotation prohibition terminal selection is valid, the forward rotation running command is invalid in the stop state, and the free running is stopped in the forward running state;

When the reverse prohibition terminal selection is valid, the reverse running command is invalid in the stop state, and the free running is stopped in the reverse running state;

55-59: Reserved

60: Speed torque control switching

This function is valid under vector control. When the terminal is valid, the motor is switched from speed control to torque control.

61: Reserved

62-63: Reserved

F05.1x group: X1-X5 detection delay

F05.10~F05.11: Terminal X1 detection delay

Code (Addr.)	Name	Content	Factory setting (Setting range)
F05.10 (0x050A) RUN	X1 effective detection delay	V/F SVC Delay time corresponding to the transition of the terminal X1 from the inactive state to the active state	0.010s (0.000 ~ 6.000s)
F05.11 (0x050B) RUN	X1 uneffective check delay	V/F SVC Delay time corresponding to the transition of the terminal X1 from the active state to the inactive state	0.010s (0.000 ~ 6.000s)

Note:

➤ Increase the detection delay of terminal X1, and enhance the filtering effect on the input terminal signal.

◇ F05.12~F05.13: Terminal X2 detection delay

Code (Addr.)	Name	Content	Factory setting (Setting range)
F05.12 (0x050C) RUN	X2 effective detection delay	V/F SVC Delay time corresponding to the transition of the terminal X1 from the inactive state to the active state	0.010s (0.000 ~ 6.000s)
F05.13 (0x050D) RUN	X2 uneffective check delay	V/F SVC Delay time corresponding to the transition of the terminal X1 from the active state to the inactive state	0.010s (0.000 ~ 6.000s)

Note:

➤ Increase the detection delay of terminal X2, and enhance the filtering effect on the input terminal signal.

◇ F05.14~F05.15: Terminal X3 detection delay

Code (Addr.)	Name	Content	Factory setting (Setting range)
F05.14 (0x050E) RUN	X3 effective detection delay	V/F SVC Delay time corresponding to the transition of the terminal X1 from the inactive state to the active state	0.010s (0.000 ~ 6.000s)
F05.15 (0x050F) RUN	X3 ineffective check delay	V/F SVC Delay time corresponding to the transition of the terminal X1 from the active state to the inactive state	0.010s (0.000 ~ 6.000s)

Note:

➤ Increase the detection delay of terminal X3, and enhance the filtering effect on the input terminal signal.

◇ F05.16~F05.17: Terminal X4 detection delay

Code (Addr.)	Name	Content	Factory setting (Setting range)
F05.16 (0x0510) RUN	X4 effective detection delay	V/F SVC Delay time corresponding to the transition of the terminal X1 from the inactive state to the active state	0.330s (0.000 ~ 6.000s)
F05.17 (0x0511) RUN	X4 ineffective check delay	V/F SVC Delay time corresponding to the transition of the terminal X1 from the active state to the inactive state	0.330s (0.000 ~ 6.000s)

Note:

➤ Increase the detection delay of terminal X4 and enhance the filtering effect on the input terminal signal.

F05.2x group: Digital input terminal action selection

◇ F05.20: Terminal control operation mode

Code (Addr.)	Name	Content	Factory setting (Setting range)
F05.20 (0x0514) STOP	Terminal control mode	V/F SVC Set terminal control mode	0 (0 ~ 3)

0: Two-wire control 1

The operation is in one direction. This mode is the most commonly used two-wire mode. The factory default is to determine the forward and reverse running of the motor by the X1 (forward running) and X2 (reverse running) terminal commands. As shown below:

K1	K2	running command
0	0	Stop
1	0	Forward
0	1	Reverse
1	1	Stop

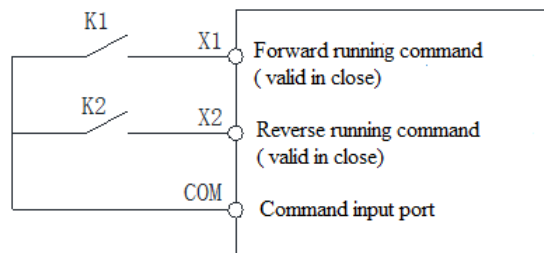

1: two-wire control 2

The operation is separated from the direction. The forward running terminal X1 (forward running) defined in this mode is the operation enable terminal. The definition of the direction is determined by the state of the reverse running terminal X2 (reverse running). As shown below:

K1	K2	running command
0	0	Stop
1	0	Forward
1	1	Reverse
0	1	Stop

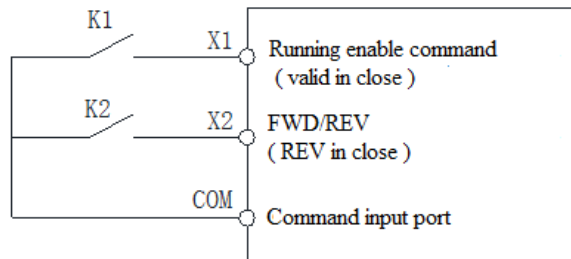

2: Three-wire control 1

In this mode, the three-wire operation control terminal (Xi) is the stop operation terminal, and the running command is generated by the forward rotation operation terminal X1 (forward rotation operation), and the direction is controlled by the reverse rotation operation terminal X2 (reverse rotation operation). The three-wire operation control terminal (Xi) is an effective input.

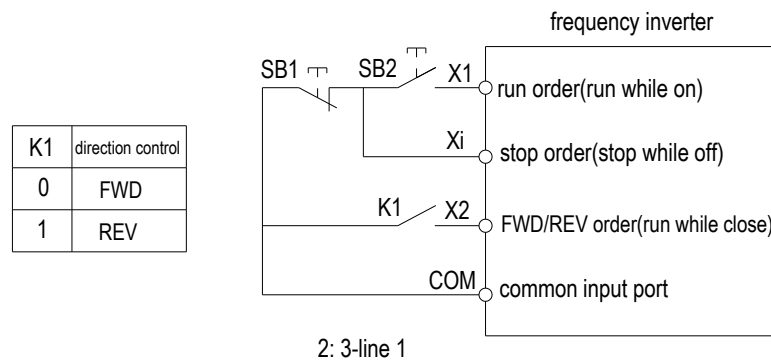

3: Three-wire control 2

In this mode, the three-wire operation control terminal (Xi) is the stop operation terminal, and the operation command is generated by the forward rotation operation terminal X1 (forward rotation operation) or the reverse rotation operation terminal X2 (reverse rotation operation), and both control the running direction.

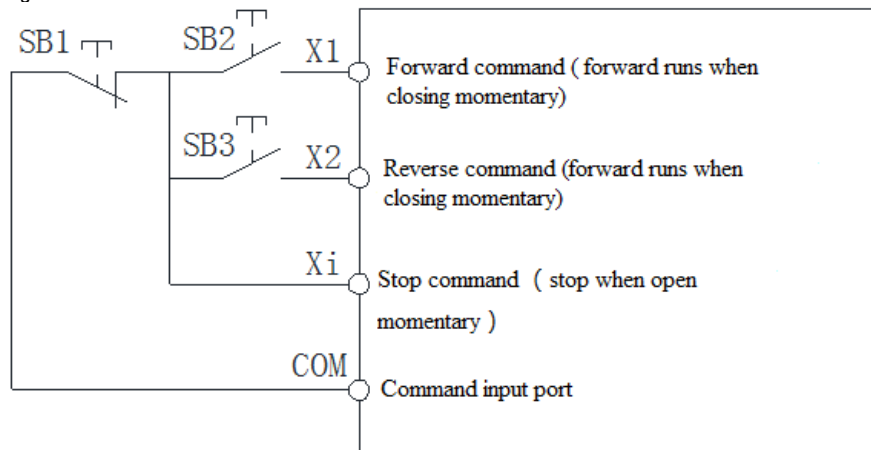

Hint: SB1: Stop button; SB2: Forward run button; SB3: Reverse run button; "Xi" is multi-function input terminal set to "3" [3-wire operation control (Xi)].

Note:

- When the set frequency is lower than the starting frequency, the inverter will not start, it will be in the standby state, and the running indicator will light.

◇ F05.22: X1~X4 terminal characteristics selection

Code (Addr.)	Name	Content	Factory setting (Setting range)
F05.22 (0x0516) RUN	X1~X4 terminal characteristics selection	V/F SVC Select terminal X1~X4 to be closed or open	0000 (0 ~ 0x1111)

Note: The inverter defaults to the terminal closing. If the selection is valid, you need to pay attention to the power-on initialization. When the terminal is disconnected, the closing signal will be output for a while.

Unit: Terminal X1

0: Closed valid

1: disconnection is valid

Ten places: terminal X2

0: Closed valid

1: disconnection is valid

Hundreds place: terminal X3

0: Closed valid

1: disconnection is valid

Thousands: terminal X4

0: Closed valid

1: disconnection is valid

◇ F05.25: Terminal adjustment frequency delivery mode

Code (Addr.)	Name	Content	Factory setting (Setting range)
F05.25 (0x0517) STOP	Terminal adjustment frequency mode	V/F SVC Set the way the terminal increments or decrements the frequency	0 (0 ~ 2)

Note: This parameter is valid only when [10: Frequency increment or 11: Frequency decrement] is selected for the multi-function input terminal function.

0: Power down shutdown storage

When the terminal adjustment frequency is incremented or decremented, the frequency record is maintained after the machine is powered off or stopped. During power-on operation, the frequency converter increases and decreases the frequency from the last stop.

1: Power down is not stored, stop storage

When the terminal adjustment frequency is incremented or decremented, the frequency record is maintained after the machine stops. During the next run, the frequency converter increases and decreases the frequency from the last stop. Recording is not saved after power failure, starting from 0.00Hz.

2: Run is valid, stop is cleared

When the terminal adjustment frequency is incremented or decremented, the frequency record is not maintained after the machine stops or after power failure. During the next run, the inverter increases and decreases the adjustment from the frequency of 0.00Hz.

◇ F05.26: Terminal UP/DW control frequency increase and decrease rate

Code (Addr.)	Name	Content	Factory setting (Setting range)
F05.26 (0x0518) RUN	Terminal UP/DW controls frequency increase and decrease rate	V/F SVC Set terminal UP/DW to control the frequency increase and decrease rate	0.50 (0.01 ~ 50.00Hz/s)

Note: When the terminal is active for a long time, the rate of increase or decrease will increase.

◇ F05.27: Terminal emergency stop deceleration time

Code (Addr.)	Name	Content	Factory setting (Setting range)
F05.27 (0x0519) RUN	Terminal emergency stop deceleration time	V/F SVC Set the deceleration time under the terminal emergency stop command	1.00s (0.01 ~ 650.00s)

Note: This parameter is valid only when [7: Emergency stop] is selected for the multi-function input terminal function.

F05.3x group: Pulse frequency input (PUL) terminal

◇ F05.30: Pulse frequency input signal selection

Code (Addr.)	Name	Content	Factory setting (Setting range)
F05.30 (0x051E) STOP	Pulse frequency input signal selection	V/F SVC Select the matching mode according to the signal input on the terminal port	2 (0 ~ 2)

0: reserved

1: reserved

2: X4 terminal is selected as frequency input port, the maximum frequency is 100.00KHz

In the case of mode 2, F05.31, F05.33, and C00.19 are 2 decimal places.

Note:

➤ The pulse frequency signal recommends a duty cycle of 50%.

◇ F05.31~F05.34: PUL input linear processing

Code (Addr.)	Name	Content	Factory setting (Setting range)
F05.31 (0x051F) RUN	PUL input minimum frequency	V/F SVC Set the lowest frequency that can be accepted, the frequency signal below this value, and process according to the frequency	0.000KHz (0 ~ 50.000KHz, F05.30=0) (0 ~ 100.00KHz, F05.30=1、2)
F05.32 (0x0520) RUN	PUL input minimum frequency corresponding setting	V/F SVC Set the percentage of the set value corresponding to the PUL minimum input frequency	0.00% (0.00 ~ 100.00%)
F05.33 (0x0521) RUN	PUL input maximum frequency	V/F SVC Set the maximum frequency that can be accepted, the frequency signal higher than this value, and process according to the frequency	5.000KHz (0 ~ 50.000KHz, F05.30=0) (0 ~ 100.00KHz, F05.30=1、2)
F05.34 (0x0522) RUN	PUL input maximum frequency corresponding setting	V/F SVC Set the percentage of the set value corresponding to the maximum input frequency of PUL	100.00% (0.00 ~ 100.00%)

The linear processing of the PUL input frequency is shown below:

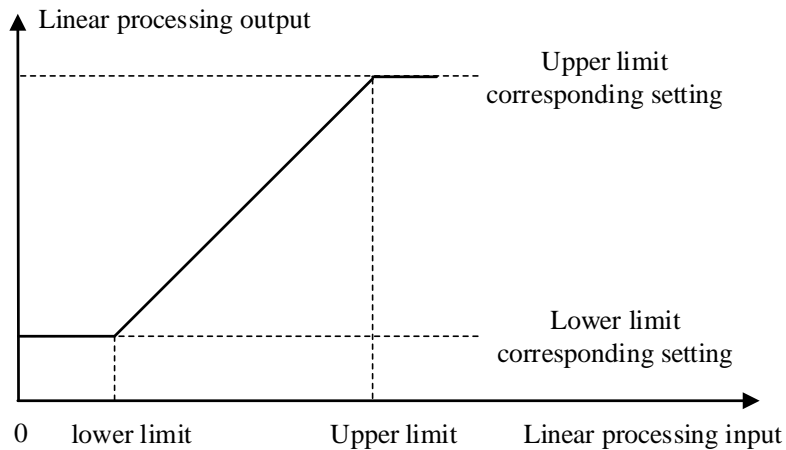

Schematic diagram of linear processing of PUL input frequency

Note:

- The decimal point of F05.31 and F05.33 parameter values is determined by the setting value of F05.30.
- After PUL is linearly processed, the output value range is F05.32~F05.34. If F01.02 = 5 [frequency given channel A = PUL given], then 100.00% corresponds to the maximum frequency, 0.00% corresponds to 0.00Hz, 0.00% Linear processing between ~100.00%

The choice of PUL input:

Table 11.2 Selection of PUL Input Applications

Parameter code	Name	Set value
F01.02	Frequency given channel A	5: PUL given
F01.04	Frequency given channel B	5: PUL given
F01.08	Run command to bind a given frequency channel	6: PUL given
F01.11	Upper frequency source selection	5: PUL given
F03.41	Torque command given channel	5: PUL given
F03.54	Torque control forward speed limit selection	5: PUL×F03.56
F03.55	Torque control reverse speed limit selection	5: PUL×F03.57
F13.00	PID controller given signal source	5: PUL given
F13.03	PID controller feedback signal source	5: PUL given

◇ ¶ F05.35: PUL filter time

Code (Addr.)	Name	Content	Factory setting (Setting range)
F05.35 (0x0523) RUN	PUL filter time	V/F SVC Set the filter time of the input pulse signal	0.100s (0 ~ 9.000s)

Note:

- The longer the filtering time, the stronger the anti-interference ability, but the reaction speed becomes slower.

◇ ¶ F05.36: PUL cutoff frequency

Code (Addr.)	Name	Content	Factory setting (Setting range)
F05.36 (0x0524) RUN	PUL cutoff frequency	V/F SVC PUL port minimum recognition pulse frequency, lower than the pulse frequency of this parameter, the inverter no longer recognizes, according to the "0Hz" frequency value processing	0 (0 ~ 2)

Note:

- The smaller the value is set, the lower the pulse frequency that the PUL port can receive, but when the PUL port pulse frequency disappears, the inverter determines that the pulse input is "0 Hz" for a longer period of time.
- The PUL input signal is first judged by the cutoff frequency, then subjected to PUL linear processing, and finally filtered.

F05.4x group: analog (AI) input characteristic selection

There are two analog AI inputs in the inverter. The input source can be divided into voltage input range of 0~10.0V, current input range is 0~20mA, and the matching input source is selected by the DIP switch on the control board according to different signal sources. The factory

default dial switch dials the voltage input.

◇ ▯ F05.43: AI input curve selection

Code (Addr.)	Name	Content	Factory setting (Setting range)
F05.43 (0x052B) RUN	AI input curve selection	V/F SVC Set AI input curve selection	0x0000 (0x0000 ~ 0x0022)

Unit position: AI curve selection

0: Straight line Two-point line, the factory defaults to this mode.

1: Curve 1 multi-point stitching.

2: Curve 2 multi-point stitching.

Ten: reserved

F05.5x group: AI linear processing

Processing of analog AI input: After input signal sampling, press F05.54 [AI filter time] to set the time for filtering, and then use F05.43 [analog input curve selection] to determine linear processing or curve processing. The default is linear deal.

◇ ▯ F05.50~F05.54: Linear processing of analog AI

Code (Addr.)	Name	Content	Factory setting (Setting range)
F05.50 (0x0532) RUN	AI lower limit	V/F SVC Set the lower limit of the sampling value of the AI input inverter, and press the limit when the standard value is lower than this value.	0.0% (0.0 ~ 100.0%)
F05.51 (0x0533) RUN	AI lower limit corresponding setting	V/F SVC Set the percentage of the set value corresponding to the AI lower limit value	0.00% (-100.00 ~ 100.00%)
F05.52 (0x0534) RUN	AI upper limit	V/F SVC Set the upper limit of the sampling value of the AI input inverter. When the standard value is higher than the value, the upper limit is processed.	100.0% (0.0 ~ 100.0%)
F05.53 (0x0535) RUN	AI upper limit corresponding setting	V/F SVC Set the percentage of the set value corresponding to the AI upper limit value	100.00% (-100.00 ~ 100.00%)
F05.54 (0x0536) RUN	AI filter time	V/F SVC Set the filter time of the AI1 input signal. The AI input signal is filtered and then linearly processed.	0.100s (0 ~ 6.000s)

Note:

- The AI input can select voltage input and current input through the DIP switch on the control panel. The voltage input range is 0~10.0V, and the current input range is 0~20mA.
- The display value of C00.16 is the value of the AI input signal after being sampled by the inverter, and the range is from 0.00% to 100.00%.
- The application value of the AI input is the value corresponding to the curve processing.
- The value of the AI input signal after being sampled by the inverter.

AI input signal	Corresponding to the sampling value of the inverter
0~10V	0.0%~100.0%
0~20mA	0.0%~100.0%

The AI linear processing is shown below:

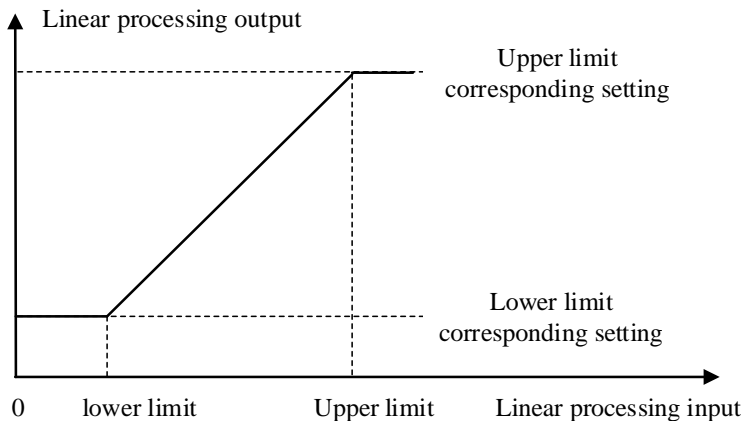

AI linear processing diagram

Table 11.2 Selection of AI Input Application

Parameter code	Name	Set value
F01.02	Frequency given channel A	2: AI given
F01.04	Frequency given channel B	2: AI given
F01.08	Run command to bind a given frequency channel	2: AI given
F01.11	Upper frequency source selection	2: AI given
F03.41	Torque command given	2: AI given
F03.54	Torque control forward speed limit selection	2: AI × F03.56
F03.55	Torque control reverse speed limit selection	2: AI × F03.57
F13.00	PID controller given signal source	2: AI given
F13.03	PID controller feedback signal source	2: AI given

F05.6x group: AI curve 1 processing

The set values of curve 1 F05.60, F05.62, F05.64, F05.66 must be set incrementally.

The set values of curve 2 F05.70, F05.72, F05.74, F05.76 must be set incrementally.

Curve 1 and curve 2 can set two inflection points, which are divided into three straight lines. The slope of each segment can be different, which can achieve a more flexible correspondence, as shown in the following figure:

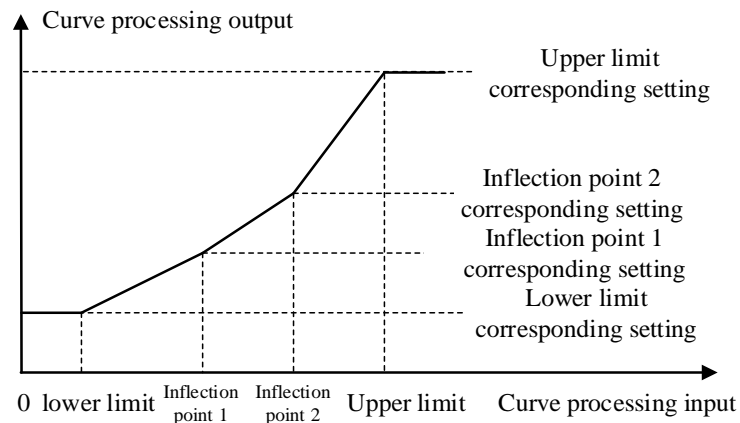

◇ F05.60~F05.67: AI input curve 1 processing

Code (Addr.)	Name	Content	Factory setting (Setting range)
F05.60 (0x053C) RUN	Curve 1 lower limit	V/F SVC When the AI input value is less than this value, it is processed according to the value	0.0% (0.0 ~ 100.0%)
F05.61 (0x053D) RUN	Curve 1 lower limit corresponding setting	Set the percentage of the set value corresponding to the lower limit of curve 1	0.00% (0.00 ~ 100.00%)
F05.62 (0x053E) RUN	Curve 1 inflection point 1	V/F SVC Set the value of curve 1 inflection point 1	30.0% (0.0 ~ 100.0%)
F05.63 (0x053F) RUN	Curve 1 inflection point 1 corresponding setting	Set the percentage of the set value corresponding to the inflection point 1 of curve 1	30.00% (0.00 ~ 100.00%)
F05.64 (0x0540) RUN	Curve 1 inflection point 2	V/F SVC Set the value of curve 1 inflection point 2	60.0% (0.0 ~ 100.0%)
F05.65 (0x0541) RUN	Curve 1 inflection point 2 corresponding setting	Set the percentage of the set value corresponding to the inflection point 2 of curve 1	60.00% (0.00 ~ 100.00%)
F05.66 (0x0542) RUN	Curve 1 upper limit	V/F SVC When the AI input value is greater than this value, it is processed according to the value	100.0% (0.0 ~ 100.0%)
F05.67 (0x0543) RUN	Curve 1 upper limit corresponding setting	Set the percentage of the set value corresponding to the upper limit of curve 1	100.00% (0.00 ~ 100.00%)

F05.7x group: AI curve 2 processing

◇ F05.70~F05.77: AI input curve 2 processing

Code (Addr.)	Name	Content	Factory setting (Setting range)
F05.70 (0x0546) RUN	Curve 2 lower limit	V/F SVC When the AI input value is less than this value, it is processed according to the value	0.0% (0.0 ~ 100.0%)
F05.71 (0x0547) RUN	Curve 2 lower limit corresponding setting	V/F SVC Set the percentage of the set value corresponding to the lower limit of curve 2	0.00% (0.00 ~ 100.00%)
F05.72 (0x0548) RUN	Curve 2 inflection point 1	V/F SVC Set the value of curve 2 inflection point 1	30.0% (0.0 ~ 100.0%)
F05.73 (0x0549) RUN	Curve 2 inflection point 1 corresponding setting	V/F SVC Set the percentage of the set value corresponding to the inflection point of curve 2	30.00% (0.00 ~ 100.00%)
F05.74 (0x054A) RUN	Curve 2 inflection point 2	V/F SVC Set the value of curve 2 inflection point 2	60.0% (0.0 ~ 100.0%)
F05.75 (0x054B) RUN	Curve 2 inflection point 2 corresponding setting	V/F SVC Set the percentage of the set value corresponding to the inflection point 2 of curve 2	60.00% (0.00 ~ 100.00%)
F05.76 (0x054C) RUN	Curve 2 upper limit	V/F SVC When the AI input value is greater than this value, it is processed according to the value	100.0% (0.0 ~ 100.0%)
F05.77 (0x054D) RUN	Curve 2 upper limit corresponding setting	V/F SVC Set the percentage of the set value corresponding to the upper limit of curve 2	100.00% (0.00 ~ 100.00%)

F05.8x group: AI as digital input terminal

The analog input AI can judge the high and low levels according to the input voltage level, and then use the high and low level analog digital input terminals. The function selection is the same as terminals X1~X4.

◇ ▯ F05.80: AI input as a digital input terminal characteristic selection

Code (Addr.)	Name	Content	Factory setting (Setting range)
F05.80 (0x0550) RUN	AI input as a digital input terminal feature selection	V/F SVC Set the characteristics of AI as a digital input terminal	0000 (0 ~ 0x0011)

Unit: AI
0: active low
1: active high
Ten: reserved

◇ ▯ F05.81: AI as a digital input terminal function selection

Code (Addr.)	Name	Content	Factory setting (Setting range)
F05.81 (0x0551) STOP	AI as a digital input terminal function selection	V/F SVC Set AI as a digital input terminal function	0 (0 ~ 95)

Note:

- The AI function as a digital input terminal has the same function selection range as the terminals X1~X4.

◇ ▯ F05.82~F05.83: AI high and low setting

Code (Addr.)	Name	Content	Factory setting (Setting range)
F05.82 (0x0552) RUN	AI high level setting	V/F SVC AI input sampling value is greater than the set value, is high	70.00% (0 ~ 100.00%)

F05.83 (0x0553) RUN	AI low level setting	V/F SVC The AI input sampling value is less than the set value and is low.	30.00% (0 ~ 100.00%)
---------------------------	----------------------	---	-------------------------

Note:

- F05.82 setting value must be greater than F05.83 to effectively distinguish between high and low levels.
- The AI input value is between F05.82 and F083, and the hysteresis is judged according to the previous state to distinguish between high and low levels.

11.8 F06 Group: output terminal

The F06 parameter group is used to set the analog monitoring of the inverter, and can select the selection of the monitoring item, the adjustment of the gain and offset, and the selection of the output signal level.

F06.0x group: AO (analog, frequency) output

F06.0x is used to set the analog monitoring of the inverter, and can select the selection of the monitoring item, the adjustment of the gain and offset, and the selection of the output signal level.

The inverter contains one AO output, and two different types of signal outputs, voltage and current, can be selected through the dial switch. The calibration of the meter connected to the multi-function analog output terminal can be performed using F06.02, F06.03, F06.04, F06.05, and F06.06.

Parameter	Name	Predetermined area	Factory setting
F06.00	AO output mode selection	0: 0 ~ 10V 1: 4.00 ~ 20.00mA 2: 0.00 ~ 20.00mA	0
F06.01	AO output selection	0 ~ 19	0
F06.02	AO output gain	25.0 ~ 200.0%	100.0%
F06.03	AO analog output offset	-10.0 ~ 10.0%	0.0%
F06.04	AO output filtering	0.000 ~ 6.000s	0.010s

The benefits of gain and offset are shown in the figure below.

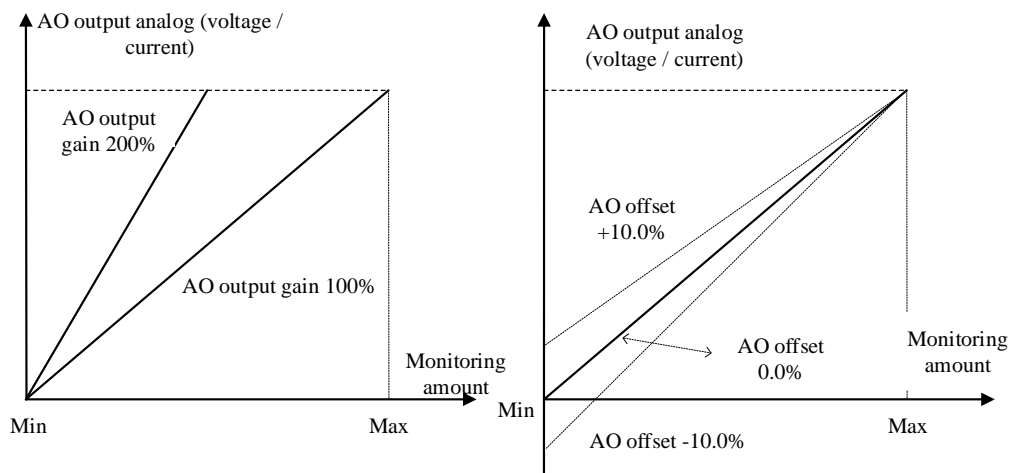

AO analog output and gain, offset schematic

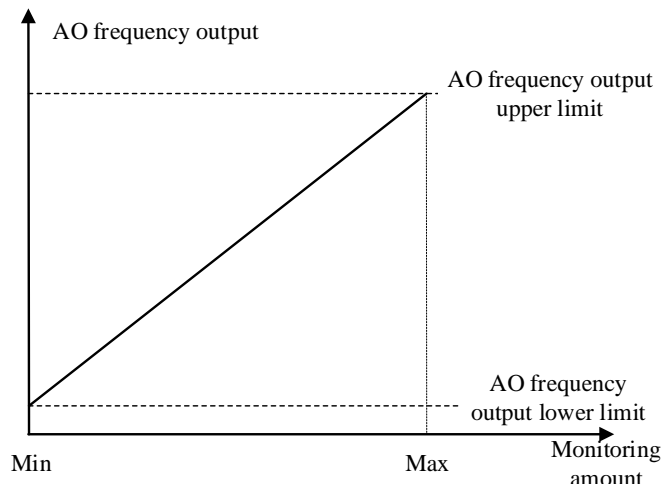

AO port pulse frequency output diagram

◇ F06.00: AO output mode selection

Code (Addr.)	Name	Content	Factory setting (Setting range)
F06.00 (0x0600) RUN	AO output mode selection	V/F SVC Set the form of the analog output signal.	0 (0 ~ 2)

0:0~10V mode

1:4.00~20.00mA mode

2: 0.00 to 20.00 mA mode

Note:

- F06.00 Selecting a different mode requires dialing the dial switch on the control panel to the corresponding position.

◇ ▯ F06.01: AO output selection

Code (Addr.)	Name	Content	Factory setting (Setting range)
F06.01 (0x0601) RUN	AO output selection	V/F SVC Set the amount of analog output.	0 (0 ~ 19)

Set value	Name	0.00% corresponding value	100.00% corresponding value
0	Given frequency	0.00Hz	Maximum frequency
1	Output frequency	0.00Hz	Maximum frequency
2	Output current	0.00A	2 times rated current of the inverter
3	Input voltage	0.0V	2 times rated voltage of the inverter
4	The output voltage	0.0V	Rated voltage of the inverter
5	Mechanical speed	0rpm	The speed corresponding to the maximum frequency
6	Given torque	0.00% torque	200% torque
7	Output torque	0.00% torque	200% torque
8	PID given	0.00% PID given	100% PID given
9	PID feedback	0.00% PID feedback	100% PID feedback
10	Output Power	0Kw	Rated output power
11	bus voltage	0V	2 times rated DC voltage of the inverter
12	AI1 input value	AI1 input lower limit	AI1 input upper limit
13	AI2 input value	AI2 input lower limit	AI2 input upper limit
14	Reserved		
15	PUL input value	PUL input lower limit	PUL input upper limit
16	Module temperature 1	0 degrees Celsius	100 degrees Celsius
17	Module temperature 2	0 degrees Celsius	100 degrees Celsius
18	RS485 given	0	1000
19	Virtual terminal vY1	Invalid output	Output is valid

Note:

- The rated DC voltage is the rated voltage of the inverter *1.414.

◇ ▯ F06.02: AO output gain

Code (Addr.)	Name	Content	Factory setting (Setting range)
F06.02 (0x0602) RUN	AO output gain	V/F SVC Set the gain of the analog output	100.0% (0 ~ 200.0%)

◇ ▯ F06.03: AO output offset

Code (Addr.)	Name	Content	Factory setting (Setting range)
--------------	------	---------	---------------------------------

F06.03 (0x0603) RUN	AO output bias	V/F SVC Set the offset of the analog output signal	0.0% (-10.0 ~ 10.0%)
---------------------------	----------------	---	-------------------------

◇ ▯ F06.04: AO output filter

Code (Addr.)	Name	Content	Factory setting (Setting range)
F06.04 (0x0604) RUN	AO output filtering	V/F SVC Set the filter time of the analog output signal	0.010s (0.000 ~ 6.000s)

F06.1x group: reserved

F06.2x-F06.3x group: Multi-function output terminal

The RD05 inverter contains 1 digital output and 1 relay output.

Code	Name	Factory setting	Default function
F06.21	Output terminal Y	1	Running
F06.22	Relay 1 output (TA-TB-TC)	4	In failure

Refer to the table below to set the function of F06.0x [Function selection of multi-function output terminal].

Set value	Features	Reference
0	no output	The terminal does not operate.
1	The inverter is running	The output is judged according to the operating state of the inverter.
2	Inverter running in reverse	
3	The inverter is running in forward rotation	
4	Fault trip alarm 2 (no alarm during fault self-recovery)	
5	Fault trip alarm 2 (no alarm during fault self-recovery)	
6	External downtime	
7	Inverter undervoltage	Reserved
8	The inverter is ready for operation	Reserved
9	Output frequency level detection 1 (FDT1)	Reserved
10	Output frequency level detection 2 (FDT2)	Reserved
11	Arrived at a given frequency	Reserved
12	Zero speed operation	Reserved
13	Upper limit frequency arrival	Reserved
14	Lower limit frequency arrival	Reserved
15	Program run cycle completion	Reserved
16	The running phase of the program is completed.	Reserved
17	PID feedback exceeds the upper limit	Refer to F13.27 parameter description
18	PID feedback is below the lower limit	Refer to F13.28 parameter description
19	PID feedback sensor disconnection	Refer to the F13.25 parameter description
20	Meter length arrives	Reserved
21	Timer time to	Reserved
22	Counter reaches maximum	Reserved
23	Counter reaches the set value	Reserved
24	Energy consumption braking	Energy consumption braking starting voltage, refer to F10.15 parameter description
25	Reserved	Refer to F02.32, F02.38 parameter description
26	Emergency stop	

27	Overload pre-alarm output 1	Refer to F10.32 parameter description
28	Underload pre-alarm output 2	Refer to F10.32 parameter description
29	Inverter warning	
30	Communication address 0x3018 control output	Reference form
31	Inverter overheat warning	Refer to the F10.25 parameter description
32	Motor overheat alarm output	Refer to F10.26 parameter description
33	Reserved	
34	Run pause output (module blocked)	
35	Torque limit	
36	Speed limit	
37	Comparator 1	Refer to F06.4x Monitoring Parameter Comparator Output 1
38	Comparator 2	Refer to F06.4x Monitoring Parameter Comparator Output 2
39	Reserved	The terminal does not operate.
40~47	Reserved	The output is judged according to the operating state of the inverter.
48~63	Reserved	

No. 30 output terminal function: MODBUS RS485 communication control multi-function output function selection, write value to BIT0~BIT1 in communication address 0x3018, output terminal corresponding to controller. The specific correspondence is as follows:

Mailing address	Name
0x3018	BIT0: corresponding output terminal Y
	BIT1: Corresponding relay 1 output (TA-TB-TC)

◇ F06.20: Multi-function output terminal polarity selection

Code (Addr.)	Name	Content	Factory setting (Setting range)
F06.20 (0x0614) RUN	Output terminal Y function selection	V/F SVC Setting the function of the multi-function output terminal Y	0000 (0000 ~ 0x1111)

Unit position: Y terminal

0: Positive polarity Active state Y output terminal low level, equivalent normally open

1: Negative polarity Effective state Y output terminal has no output, equivalent normally open

Tens place: relay 1 output terminal

0: Positive polarity TA-TC is normally open, TB-TC is normally closed

1: Negative polarity TA-TC normally closed, TB-TC normally open

Hundreds: reserved

Thousands: reserved

◇ F06.21: Output terminal Y function selection

Code (Addr.)	Name	Content	Factory setting (Setting range)
F06.21 (0x0615) RUN	Output terminal Y function selection	V/F SVC Setting the function of the multi-function output terminal Y	1 (0 ~ 63)

◇ F06.22: Relay 1 function selection

Code (Addr.)	Name	Content	Factory setting (Setting range)
F06.22 (0x0616) RUN	Relay 1 function selection	V/F SVC Set the function of the multi-function output relay terminal	4 (0 ~ 63)

Note:

- When the relay function is inactive, the TB-TC is normally closed and the TA-TC is normally open.

Multi-function output setting

0: no output

Indicates that the terminal is invalid. If the terminal function is idle, it is recommended to set it to "0" to prevent malfunction.

1: The inverter is running

A valid signal is output when the inverter is in operation.

2: The inverter is running in reverse

When the inverter is in the reverse running state, a valid signal is output.

3: The inverter is running in forward

The valid signal is output when the inverter is in forward running state.

4: Fault trip alarm 1 (alarm during fault self-recovery)

When the inverter is faulty, including the fault self-recovery period, the output signal.

5: Fault trip alarm 2 (no alarm during self-recovery)

When the inverter is faulty, it does not include the fault self-recovery period and outputs a valid signal.

6: External downtime

When the multi-function input terminal inputs an external fault signal and reports the external fault E. EF of the inverter, it outputs a valid signal.

7: Inverter undervoltage

A valid signal is output when the inverter is under voltage.

8: The inverter is ready for operation

When the signal is valid, it means that the inverter has no fault, the bus voltage is normal, the operation prohibition terminal such as emergency stop or emergency stop of the inverter is invalid, and it can be operated after accepting the start command.

9: Output frequency level detection 1 (FDT1)

When the output frequency of the inverter exceeds the set value of F06.40 [Frequency Detection Value 1] 1/4 After the hysteresis frequency set by F06.41 [Frequency Detection Range 1], the valid signal is output, when the output frequency of the inverter Below the frequency detection level, after the same hysteresis frequency, an invalid signal is output. For details, see F06.40 [Frequency Detection Value 1] and F06.41 [Frequency Detection Amplitude 1] parameter description.

10: Output frequency level detection 2 (FDT2)

When the output frequency of the inverter exceeds the set value of F06.42 [Frequency Detection Value 2], after the hysteresis frequency set by F06.43 [Frequency Detection Amplitude 2], the valid signal is output, when the output frequency of the inverter Below the frequency detection level, after the same hysteresis frequency, an invalid signal is output. For details, see F06.40 [Frequency Detection Value 2] and F06.41 [Frequency Detection Range 2] parameter description.

11: A given frequency arrives

When the output frequency of the inverter is close to or reaches a given frequency to a certain range (the range is determined by parameter F06.44 [a given frequency reaches the detection amplitude]), the valid signal is output, otherwise the invalid signal is output. See F06.44 [A given frequency arrival detection range] for details.

12: Running at zero speed

When the inverter is running and the output is 0.00Hz, a valid signal is output.

13: The upper limit frequency arrives

When the inverter runs at the upper limit frequency, it outputs a valid signal.

14: Lower limit frequency arrives

When the inverter runs at the lower limit frequency, it outputs a valid signal.

15: Program running cycle completion When the program runs one cycle end, it outputs a valid signal of 500ms.

16: program running phase is completed

When the program runs at the end of a phase, a valid signal of 500ms is output.

17: PID feedback exceeds the upper limit

When the PID feedback amount reaches F13.27 [Broken Line Alarm Upper Limit], the feedback signal will exceed the limit after F13.26 [Feedback Line Detection Time], and the valid signal will be output.

18: PID feedback is below the lower limit

When the PID feedback amount reaches F13.28 [Broken Line Alarm Lower Limit], the feedback signal will exceed the limit after F13.26 [Feedback Line Detection Time], and the valid signal will be output.

19: PID feedback sensor disconnected

When the PID feedback sensor is disconnected, a valid signal is output. See parameters F13.26~F13.28 [Feedback disconnection detection time, disconnection alarm upper limit value, feedback disconnection lower limit value].

20: Reserved

21: Timer time is up

When the inverter internal timer timing time arrives, the port outputs a valid pulse signal with a width of 1 second. See parameter F08.07 [Timer Time Unit], F08.08 [Timer Set Value].

22: Counter reaches the maximum value

When the counter reaches the maximum value, the output terminal outputs a valid signal with a width equal to the external clock period, and the counter is cleared. See parameter F08.02 [Counter Maximum].

23: Counter reaches the set value

When the counter reaches the set value, the output terminal outputs a valid signal, and continues to count until the counter exceeds the maximum value, causing the counter to be cleared, and the output valid signal is cancelled. See parameter F08.03 [Counter set value].

24: Energy braking

When the inverter meets the energy consumption braking condition, it outputs a valid signal. See parameter F10.14 [Energy Brake Enable] for details.

25: Reserved

26: Emergency stop

When the inverter is in the emergency stop state, a valid signal is output.

27: Load pre-alarm output 1

When the inverter is running, in the VF control mode, the motor output current is used as the load warning ^ break value; in the vector control mode, the motor output torque is used as the load warning judgment value, and the load warning judgment value is compared with the load warning detection level to determine whether Output a valid signal. See parameter F10.32~F10.34 [Load warning detection setting, load warning detection level 1, load warning detection time 1].

28: Load pre-alarm output 2

When the inverter is running, in the VF control mode, the motor output current is used as the load warning ^ break value; in the vector control mode, the motor output torque is used as the load warning judgment value, and the load warning judgment value is compared with the load warning detection level to determine whether Output a valid signal. See parameter F10.32 [Load warning detection setting], F10.35~F10.36 [load warning detection level 2, load warning detection time 2].

29: Reserved

30: RS485 given

Through RS485 communication (0x3018/0x2018) setting, BIT0 bit corresponds to Y output, BIT1 corresponds to relay 1 output, and BIT2 bit corresponds to relay 2 output.

31: Inverter overheat warning

When the motor temperature detected by the expansion card reaches F10.25 [inverter overheating oH1 warning detection level], a valid signal is output.

32: Expansion card temperature reaches output

When the motor temperature detected by the expansion card reaches F10.27 [Motor overheat alarm level], a valid signal is output.

33: Reserved

34: Run pause output

The valid signal is output when the inverter is in the running pause output state.

35: Torque limit

When the inverter is in the torque limit state, a valid signal is output.

36: speed limit

When the inverter is in the speed limit state, a valid signal is output.

37: Comparator 1

When the value of the monitoring item set by F06.50 [Comparator 1 monitor selection] is within the range of F06.51 [Comparator 1 upper limit] and F06.52 [Comparator 1 lower limit], a valid signal is output.

38: Comparator 2

When the value of the monitoring item set by F06.55 [Comparator 2 monitor selection] is within the range of F06.56 [Comparator 2 upper limit] and F06.57 [Comparator 2 lower limit value], a valid signal is output.

39: Reserved

◇ □ F06.25~ F06.32: Multi-function output terminal delay time

Code (Addr.)	Name	Content	Factory setting (Setting range)
F06.25 (0x0619) RUN	Y terminal ON delay time	V/F SVC Set the delay time for the Y terminal to switch from OFF to ON	0.010 (0.000 ~ 60.000s)
F06.26 (0x061A) RUN	Relay 1 terminal ON delay time	V/F SVC Set the delay time for the Y terminal to switch from OFF to ON	0.010 (0.000 ~ 60.000s)
F06.29 (0x061D) RUN	Y terminal OFF delay time	V/F SVC Set the delay time for the Y terminal to switch from ON to OFF	0.010 (0.000 ~ 60.000s)
F06.30 (0x0619) RUN	Relay 1 terminal OFF delay time	V/F SVC Set the delay time for the Y terminal to switch from ON to OFF	0.010 (0.000 ~ 60.000s)

F06.4x group: frequency detection

It is used to set the signal such as frequency coincidence and frequency arrival to the multi-function output terminal.

The inverter contains two sets of frequency detection judgment parameters.

The output frequency is detected as shown below:

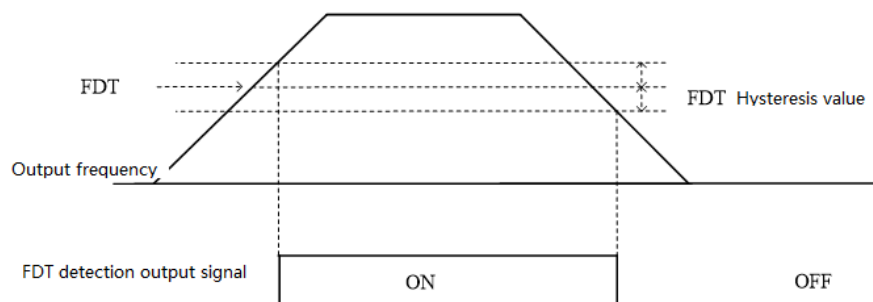

Frequency level detection diagram

◇ □ F06.40: Frequency detection value 1

Code (Addr.)	Name	Content	Factory setting (Setting range)
F06.40 (0x0628) RUN	Frequency detection value 1	V/F SVC Set the frequency detection value	30.00Hz (0.00 ~ F01.10)

Note:

- The comparison object of the frequency detection value is the target frequency.

◇ ¶ F06.41: Frequency detection range 1

Code (Addr.)	Name	Content	Factory setting (Setting range)
F06.41 (0x0629) RUN	Frequency detection amplitude 1	V/F SVC Set the frequency detection range	1.00Hz (0.00 ~ F01.10)

◇ ¶ F06.42: Frequency detection value 2

Code (Addr.)	Name	Content	Factory setting (Setting range)
F06.42 (0x062A) RUN	Frequency detection value 2	V/F SVC Set the frequency detection value	50.00Hz (0.00 ~ F01.10)

Note:

- The comparison object of the frequency detection value is the target frequency.

◇ ¶ F06.43: Frequency detection range 2

Code (Addr.)	Name	Content	Factory setting (Setting range)
F06.43 (0x062B) RUN	Frequency detection range 2	V/F SVC Set the frequency detection range	1.00Hz (0.00 ~ F01.10)

◇ ¶ F06.44: The given frequency reaches the detection range

Code (Addr.)	Name	Content	Factory setting (Setting range)
F06.44 (0x062C) RUN	The given frequency reaches the detection range	V/F SVC Set the given frequency to reach the detection range	2.00Hz (0.00 ~ F01.10)

The frequency arrival output is shown below:

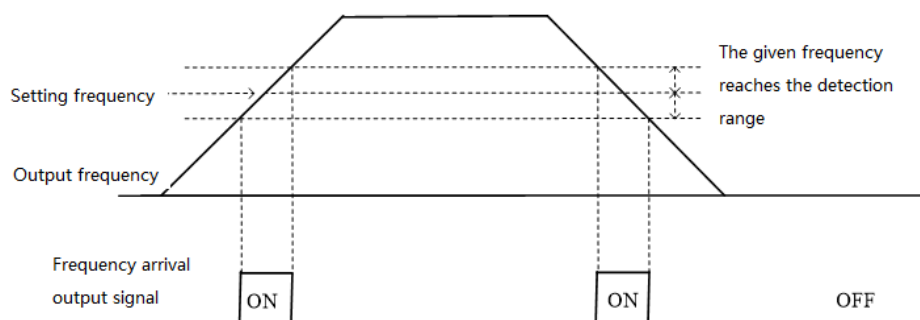

Frequency arrival detection diagram

Note:

- The comparison object of the frequency detection value is the target frequency.

F06.5x group: Monitor parameter comparator output

The set of parameters sets any one of the monitoring parameters for comparison by the comparator, and selects a multi-function output terminal, an alarm or an alarm according to the judgment result. Meet the comparison output of various monitoring variables.

◇ ¶ F06.50~F06.53: Comparator 1 (CP1)

Code (Addr.)	Name	Content	Factory setting (Setting range)
--------------	------	---------	---------------------------------

F06.50 (0x0632) RUN	Comparator 1 monitor selection	V/F SVC Select the monitor amount of comparator 1 Ten digits: yy setting in monitoring parameter number Cxx.yy Hundreds of thousands: monitoring parameter number Cxx.yy xx setting	0001 (0000 ~ 0x0763)
F06.51 (0x0633) RUN	Comparator 1 upper limit	V/F SVC Set the upper limit of comparator 1. Unit and decimal point depend on F06.50	(Related to F06.50)
F06.52 (0x0634) RUN	Comparator 1 lower limit	V/F SVC Set the lower limit of comparator 1. Unit and decimal point depend on F06.50	(Related to F06.50)
F06.53 (0x0635) RUN	Comparator 1 bias	V/F SVC Set the offset value of comparator 1. Unit and decimal point depend on F06.50	(Related to F06.50)
F06.54 (0x0636) RUN	Comparator 1 action selection	V/F SVC Select the action of comparator 1. 0: Continue running (digital terminal output only) 1: Alarm and free parking, E.CP1 2: Warning and continue to run, A.CP1 3: Forced shutdown	0 (0 ~ 3)

Note:

- Comparator 1 action selection = 3: Forced stop, but when the inverter is given different stop command commands, stop according to the set stop mode.

◇ F06.55~F06.59: Comparator 2 (CP2)

Code (Addr.)	Name	Content	Factory setting (Setting range)
F06.55 (0x0637) RUN	Comparator 2 monitor selection	V/F SVC Select the monitor amount of Comparator 2 Ten digits: yy setting in monitoring parameter number Cxx.yy Hundreds of thousands: monitoring parameter number Cxx.yy xx setting	0001 (0000 ~ 0x0763)
F06.56 (0x0638)	Comparator 2 upper limit	V/F SVC Set the upper limit of comparator 2. Unit and decimal point depend on F06.55	(depends on F06.55)
F06.57 (0x0639) RUN	Comparator 2 lower limit	V/F SVC Set the lower limit of comparator 2. Unit and decimal point depend on F06.55	(depends on F06.55)
F06.58 (0x063A) RUN	Comparator 2 bias	V/F SVC Set the offset value of comparator 2. Unit and decimal point depend on F06.55	(depends on F06.55)
F06.54 (0x0636) RUN	Comparator 2 action selection	V/F SVC Set the action of comparator 2 0: Continue running (digital terminal output only) 1: alarm and free parking 2: Warning and continue to run 3: Forced shutdown	0 (0 ~ 3)

Note:

- Comparator 2 action selection = 3: Forced stop, but when the inverter is given different stop command commands, stop according to the set stop mode.

F06.6x group: virtual input and output terminals

The virtual input and output function can realize the following functions.

- Input the output of the multi-function output terminal to the multi-function input terminal without external wiring.
- Input the output of the multi-function analog output terminal to the multi-function analog input terminal without external wiring.

WARNING: Safety measures when restarting the machine: Be sure to check the setting values of the parameters for the virtual input/output function before the inverter is commissioned. If it is neglected, the inverter will operate unexpectedly and may cause personal accidents.

The virtual input/output function is to make the virtual connection of the input and output terminals inside the inverter. Therefore, even if there is no wiring on the input and output terminals, the operation of the inverter may be different from the factory setting.

The virtual terminal vY1~vY4 output delay setting is the same as the Y terminal and relay delay. For details, please refer to [F06.20~F06.22]. The virtual terminal is characterized by the combination of vXi and vYi. When you want to use the Y terminal output signal as the X terminal input signal, you can use the internal vXi and vYi virtual connection to achieve the purpose of use, thus saving the actual X and Y terminals for other Aspect use.

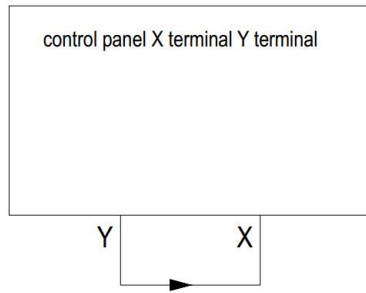

Connecting by external X and Y terminal

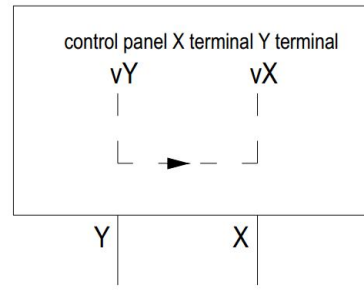

Connecting by virtual terminal internal connection

The following examples illustrate the application of virtual vX and vY:

Example 1: In some cases, the inverter is required to be initialized when the power is turned on. In general, an X terminal is used as an input.

Eg: If you use a virtual terminal, you can save this actual X terminal for other inputs, as follows:

Set F01.01 = 1 to run the command source terminal control;

Set F05.20 = 0 two-wire control 1;

Set F06.60 = 1 terminal input forward running;

Setting F06.64 = 0000 The valid state of vX1 is determined by vY1;

Setting F06.66 = 8 Output is output when the inverter is ready for operation.

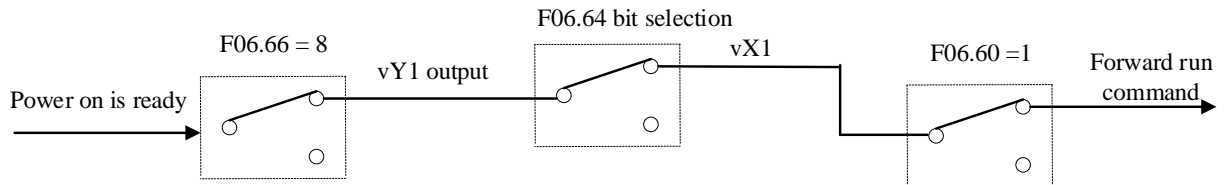

Virtual terminal control power-on automatic operation diagram

◇ F06.60~F06.63: virtual digital input setting

Code (Addr.)	Name	Content	Factory setting (Setting range)
F06.60 (0x063C) STOP	Virtual vX1 terminal function selection	V/F SVC Please refer to "Setting Value of Multi-function Input" of F05.0x.	0 (0 ~ 95)
F06.61 (0x063D) STOP	Virtual vX2 terminal function selection	V/F SVC Please refer to "Setting Value of Multi-function Input" of F05.0x.	0 (0 ~ 95)
F06.62 (0x063E) STOP	Virtual vX3 terminal function selection	V/F SVC Please refer to "Setting Value of Multi-function Input" of F05.0x.	0 (0 ~ 95)
F06.63 (0x063F) STOP	Virtual vX4 terminal function selection	V/F SVC Please refer to "Setting Value of Multi-function Input" of F05.0x.	0 (0 ~ 95)

Note:

- For details on the virtual digital input setting value, refer to "Multi-function input setting value" of F05.0x.

◇ F06.64: vX terminal valid status source

Code (Addr.)	Name	Content	Factory setting (Setting range)
F06.64 (0x0640) RUN	vX terminal valid status source	V/F SVC Set the source status of the vX terminal	0x0000 (0x0000~ 0x2222)

The input status of the virtual vX1~vX4 terminals can be set in three ways, which is selected by [F06.64];

When the state of vX1 to vX4 is connected to the internal connection of virtual vY1 to vY4, whether vX1 to vX4 are valid, depending on whether the output of vY1 to vY4 is valid or invalid, and vX1-vY1; vX2-vY2; vX3-vY3; vX4- vY4 is a one-to-one binding relationship.

When the state of vX1 to vX4 is selected and the physical terminals X1 to X4 are linked, whether vX1 to vX4 are valid or not depends on whether the X1 to X4 inputs are valid or invalid.

When the state of vX1 to vX4 is selected by the function code, whether vX1 to vX4 are valid, the status of the corresponding input terminal can be set by function code [F06.65].

Unit: Virtual vX1

0: Internal connection with virtual vY1

1: Link to physical terminal X1

2: Is the function code setting valid?

Ten places: virtual vX2
 0: Internal connection with virtual vY2
 1: Link to physical terminal X2
 2: Is the function code setting valid?
 Hundreds: Virtual vX3
 0: Internal connection with virtual vY3
 1: Link to physical terminal X3
 2: Is the function code setting valid?
 Thousands: virtual vX4
 0: Internal connection with virtual vY4
 1: Link to physical terminal X4
 2: Is the function code setting valid?

◇ F06.65: Virtual vX terminal function code setting valid status

Code (Addr.)	Name	Content	Factory setting (Setting range)
F06.65 (0x0641) RUN	Virtual vX terminal function code setting valid status	V/F SVC Set the virtual vX terminal function code to set the effective state.	0x0000 (0x0000~ 0x1111)

Unit: Virtual vX1
 0: invalid;
 1: valid
 Ten places: virtual vX2
 0: invalid;
 1: valid
 Hundreds: Virtual vX3
 0: invalid;
 1: valid
 Thousands: virtual vX4
 0: invalid;
 1: valid

◇ F06.66~F06.69: Virtual digital output setting

Code (Addr.)	Name	Content	Factory setting (Setting range)
F06.66 (0x0642) RUN	Virtual vY1 output selection	V/F SVC Please refer to the "Setting Value of Multi-function Output" of F06.2x.	0 (0 ~ 63)
F06.67 (0x0643) RUN	Virtual vY2 output selection	V/F SVC Please refer to the "Setting Value of Multi-function Output" of F06.2x.	0 (0 ~ 63)
F06.68 (0x0644) RUN	Virtual vY3 output selection	V/F SVC Please refer to the "Setting Value of Multi-function Output" of F06.2x.	0 (0 ~ 63)
F06.69 (0x0645) RUN	Virtual vY4 output selection	V/F SVC Please refer to the "Setting Value of Multi-function Output" of F06.2x.	0 (0 ~ 63)

Note:

➤ For details on the virtual digital output setting value, refer to "Setting Value of Multi-function Output" in F06.2x.

◇ F06.70~F06.77: virtual digital output judgment delay

Code (Addr.)	Name	Content	Factory setting (Setting range)
F06.70 (0x0646) RUN	vY1 output ON delay time	V/F SVC Set the delay time for the vY1 terminal to switch from OFF to ON	0.010 (0.000 ~ 60.000s)
F06.71 (0x0647) RUN	vY2 output ON delay time	V/F SVC Set the delay time for the vY2 terminal to switch from OFF to ON	0.010 (0.000 ~ 60.000s)
F06.72 (0x0648) RUN	vY3 output ON delay time	V/F SVC Set the delay time for the vY3 terminal to switch from OFF to ON	0.010 (0.000 ~ 60.000s)
F06.73 (0x0649) RUN	vY4 output ON delay time	V/F SVC Set the delay time for the vY4 terminal to switch from OFF to ON	0.010 (0.000 ~ 60.000s)

F06.74 (0x064A) RUN	vY1 output OFF delay time	V/F SVC Set the delay time for the vY1 terminal to switch from ON to OFF	0.010 (0.000 ~ 60.000s)
F06.75 (0x064B) RUN	vY2 output OFF delay time	V/F SVC Set the delay time for the vY2 terminal to switch from ON to OFF	0.010 (0.000 ~ 60.000s)
F06.76 (0x064C) RUN	vY3 output OFF delay time	V/F SVC Set the delay time for the vY3 terminal to switch from ON to OFF	0.010 (0.000 ~ 60.000s)
F06.77 (0x064D) RUN	vY4 output OFF delay time	V/F SVC Set the delay time for the vY4 terminal to switch from ON to OFF	0.010 (0.000 ~ 60.000s)

Note:

- For details on the virtual digital output delay, refer to "Setting Value of Multi-function Output" in F06.2x.

11.9 F07 Group: Operation Control

F07.0x group: Start control

The inverter can select 3 starting modes, according to the starting frequency starting mode, DC braking starting mode and speed tracking starting mode.

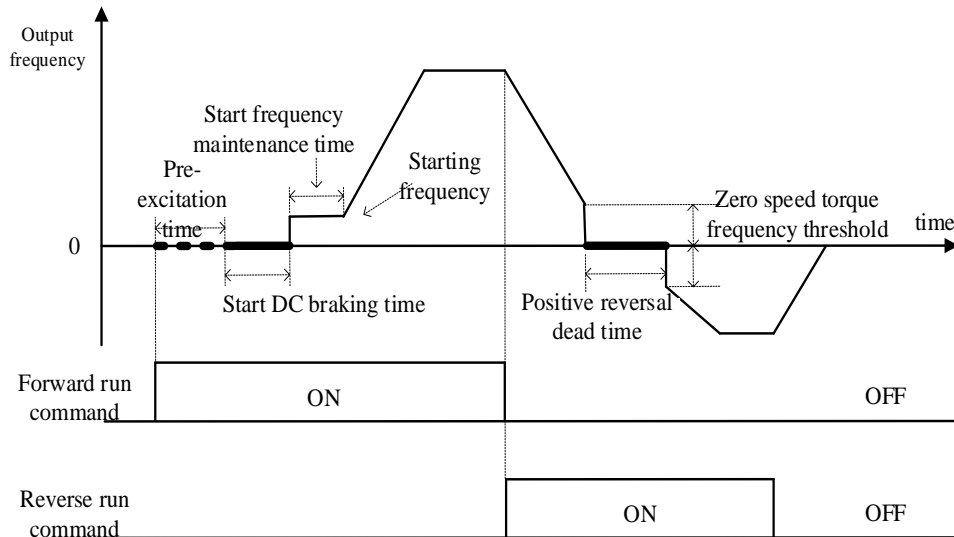

Schematic diagram of forward rotation start and forward and reverse switching process

◇ F07.00: Start operation mode

Code (Addr.)	Name	Content	Factory setting (Setting range)
F07.00 (0x0700) STOP	Start mode	V/F SVC Set the startup mode of the inverter	0 (0 ~ 2)

0: started by the start frequency

In this mode, the output frequency changes directly from F07.02 [starting frequency] according to the acceleration time.

1: After DC braking, start again by starting frequency

In this mode, first press F07.20 [start DC braking current], F07.21 [start DC braking time] to perform DC braking, and then start according to the starting frequency. Applicable to the field where the motor speed is required to be zero or lower at start-up, first give the motor a braking force and then start.

2: Speed tracking start

First detect the speed and direction of the motor, and then start according to the detected speed. Suitable for on-site quick start after large inertia load shutdown.

Note:

- When the starting frequency is less than F7.02 [starting frequency] at startup, the inverter will not start, it will be in standby state, and the running indicator will light.
- The S/T2 model does not support the speed tracking start.

◇ F07.01: Start pre-excitation time

Code (Addr.)	Name	Content	Factory setting (Setting range)
--------------	------	---------	---------------------------------

F07.01 (0x0701) STOP	Start pre-excitation time	V/F SVC Establish a magnetic field before the motor starts, and set the pre-excitation time by this parameter.	0.00 (0.00~ 60.00s)
----------------------------	---------------------------	---	------------------------

Under the asynchronous motor vector, pre-excitation before starting can effectively improve the starting performance of the motor and reduce the starting current and starting time.

Note:

- When the default is 0.00s, the actual time of starting the pre-excitation is automatically calculated according to the motor parameters.
- The S/T2 model does not support pre-excitation before starting.

◇ F07.02: Starting frequency

Code (Addr.)	Name	Content	Factory setting (Setting range)
F07.02 (0x0702) STOP	Starting frequency	V/F SVC The set value is used as the initial output frequency when the inverter starts.	0.50Hz (0.00 ~ F01.12)

To ensure the motor output torque at startup, set the appropriate starting frequency. If the setting is too large, overcurrent suppression will occur at startup, and even overcurrent faults will be reported.

Note:

- When the set frequency is lower than the starting frequency, the inverter will not start, it will be in the standby state, and the running indicator will light.

◇ F07.03: Start protection selection

Code (Addr.)	Name	Content	Factory setting (Setting range)
F07.03 (0x0703) STOP	Start protection selection	V/F SVC Select whether the given run command command is valid at startup	0 (0 ~ 0x0111)

Note: For convenience of explanation, the inverter is divided into three states: fault state, undervoltage state, and standby state. The fault state and the undervoltage state are referred to as abnormal states.

Single digit: terminal start protection when exiting abnormal

0: off

1: open

This function is valid only when the control mode is the terminal control mode.

Tens: Jog terminal start protection when exiting abnormal

0: off

1: open

Hundreds place: Start protection when the command channel is switched to the terminal

0: off

1: open

Thousands: reserved

Note:

- Start protection is enabled by default when the free stop, emergency stop, and forced stop commands are valid.
- After the terminal start protection is valid, the terminal operation command must be eliminated, and the reference is valid again.
- After the start protection is valid, there is a run command command input, no operation, and an alarm display A.078.

◇ F07.04: Reserved

Code (Addr.)	Name	Content	Factory setting (Setting range)
F07.04 (0x0704) RUN	Reserved	V/F SVC Reserved parameter	0 (0 ~ 0)

◇ F07.05: Rotation direction selection

Code (Addr.)	Name	Content	Factory setting (Setting range)
F07.05 (0x0705) STOP	Direction of rotation	V/F SVC Select the direction in which the motor runs	0111 (0 ~ 0x0111)

Note: The inverter is initialized by F00.03 [Initialization], and the parameter setting value does not change.

Unit position: reverse the running direction

0: The direction is unchanged The actual steering of the motor is the same as the required steering, and the current motor direction is not adjusted;

1: Inverted direction The actual steering of the motor is opposite to the required steering, and the current motor direction is adjusted;

Ten digits: the running direction is prohibited

Used to select the effectiveness of the motor running control direction.

0: Allow forward and reverse commands The inverter accepts forward and reverse commands to control motor operation;

1: Only forward command is allowed. The inverter only accepts the forward rotation control command to control the motor operation. If the reverse rotation command is given as an invalid command.

2: Only reverse command is allowed. The inverter only accepts the reverse control command to control the motor operation; if the forward command is given as invalid command.

Hundreds place: frequency control direction selection

It is used to select whether the negative frequency is allowed to change the current running direction of the inverter when the frequency reference value is negative.

0: Invalid frequency control direction If the calculation result is negative, the inverter outputs a frequency of 0.00Hz.

1: Frequency control direction is valid If the calculation result is negative, the inverter changes the current running direction and outputs the corresponding frequency.

Note:

- In a system, there are multiple machines that need to set the same function parameters and realize them by copying the parameters. It is recommended not to correct the direction of the motor by the reverse direction of the running direction. The three-phase output of the inverter can be adjusted to two phases.

◇ F07.06 ~ F07.07: Power failure restart action

Code (Addr.)	Name	Content	Factory setting (Setting range)
F07.06 (0x0706) STOP	Power failure restart action selection	V/F SVC Select stop and restart action function	0 (0 ~1)
F07.07 (0x0707) STOP	Power failure restart waiting time	V/F SVC Set the power failure to restart, in the standby state	0.50 (0.00 ~ 60.00s)

Power failure restart action selection:

0: Invalid After the inverter is powered off and then powered on, it must be run after receiving the running command.

1: Valid If the inverter is in running state before the power is cut off, after the power is restored, the inverter will start the automatic speed tracking after F07.07 [stop and restart waiting time].

Waiting time for shutdown and restart:

The power failure restart waiting time setting principle is based on factors such as restoring the working recovery preparation time of other equipment related to the inverter after power supply.

Note:

- During the waiting time of power failure restart, the inverter does not accept the running command, but if the stop command is input during this period, the inverter will cancel the restart state.

F07.1x group: shutdown and zero frequency control

◇ ¶ F07.10: Stop mode

Code (Addr.)	Name	Content	Factory setting (Setting range)
F07.10 (0x070A) RUN	Stop mode	V/F SVC Select the stop mode of the inverter when the run command is canceled or the stop command is input.	0 (0 ~ 1)

Note: Stop command: Contains the release command and the input stop command.

0: deceleration stop

When the stop command is input, the motor decelerates to a stop.

The motor will decelerate to a stop according to the effective deceleration time. The factory setting of the deceleration time is F01.21 [Deceleration time 1]. The actual deceleration time varies depending on load conditions such as mechanical loss and inertia.

When the output frequency during deceleration reaches or falls below the set value of F07.22 [stop DC braking start frequency], the inverter will enter the stop DC braking judgment.

1: Free stop

When the stop command is input, the output of the inverter is cut off and the motor runs freely.

The motor is free to stop at a deceleration rate formed by load conditions such as mechanical loss and inertia.

Note:

- After the inverter is in the stop state, it will not respond to the running command within the set time of F07.12 [stop and restart limit time].

◇ ¶ F07.11: Stop detection frequency

Code (Addr.)	Name	Content	Factory setting (Setting range)
--------------	------	---------	---------------------------------

F07.11 (0x070B) RUN	Shutdown detection frequency	V/F SVC Under the stop command, the judgment frequency of the deceleration stop is entered from the running state; if the output frequency is less than the set value, the blocked output enters the stop state.	0.50Hz (0.00 ~ F01.12)
---------------------------	------------------------------	---	---------------------------

The stop command is obtained in the deceleration stop mode. If the DC brake function is valid, the output DC frequency is less than F07.22 [stop DC brake start frequency] and the DC brake operation is stopped. If the DC braking function is disabled and the output frequency is less than the set value, the blocked output enters the stop state.

Note:

- In F07.10 = 1 [stop mode = free stop], the stop detection frequency judgment is not performed, and the stop DC brake action is not performed.

◇ F07.12: stop and restart limit time

Code (Addr.)	Name	Content	Factory setting (Setting range)
F07.12 (0x070C) STOP	Limit time for shutdown and restart	V/F SVC The interval between the inverter switching from the running state to the stop state and accepting the running command	0.000 (0.000 ~ 60.000s)

This function is used in situations where frequent start and stop commands are not allowed.

Note:

- During the limit time of the shutdown and restart, the operation command is not responded.

◇ F07.15: Insufficient lower limit frequency action selection

Code (Addr.)	Name	Content	Factory setting (Setting range)
F07.15 (0x070F) RUN	Insufficient lower limit frequency action selection	V/F SVC Set the action when the output frequency is less than the lower limit frequency during the running process.	0 (0 ~ 33)

Note: This function is valid when there is a running command and the output frequency is lower than the lower limit frequency, such as the positive and negative zero crossing state. Invalid during stop deceleration.

0: Run by frequency command normal operation.

1: Enter the pause state and block the output.

When the given frequency and output frequency are less than or equal to the lower limit frequency, the output is blocked and the pause state is entered, and the motor is free to stop running.

When the given frequency is greater than the lower limit frequency after entering the pause state, the pause state is exited and the normal start control is entered.

2: Run at the following frequency limit

When the given frequency and output frequency are less than or equal to the lower limit frequency, the limit frequency output is pressed.

3: Zero speed operation

When the given frequency and output frequency are less than or equal to the lower limit frequency, decelerate to zero frequency, perform zero speed control, and enter zero speed torque function control in open loop vector or VF mode.

When the given frequency is greater than the lower limit frequency after entering the zero speed control, the zero speed control is exited and the normal start control is entered.

Note:

- When F07.10 = 1 [stop mode = free stop], this function judgment is not performed.

◇ F07.16 ~ F07.17 zero speed torque retention

Code (Addr.)	Name	Content	Factory setting (Setting range)
F07.16 (0x0710) RUN	Zero speed torque holding current	V/F SVC 100.0% corresponds to the rated current of the inverter	60.0% (0.0 ~ 150.0%)
F07.17 (0x0711) RUN	Zero speed torque holding time	V/F SVC Set the time that the zero-speed torque function is maintained. Set 6000.0s zero speed torque is not limited by time	0.0s (0.0 ~ 6000.0s)

Zero speed torque holding current:

100.0% corresponds to the rated current of the inverter, but the zero-speed torque holding current is limited by the rated current of the motor. When the output frequency decelerates to the F07.02 starting frequency, it enters the zero-speed torque control state.

The zero-speed torque holding current value affects the magnetic field strength of the fixed motor shaft. Increasing the current value will increase the amount of heat generated by the motor. Set the minimum current required to fix the motor shaft.

Zero speed torque holding time:

Set the time that the zero-speed torque function is maintained. When the output frequency is less than the F07.02 start frequency, the timing starts.

Zero speed torque function effective condition

Condition	Name
control method	Vector control or V/F control
Operating status	Normal running state, non-stop deceleration
Output frequency threshold	Less than F07.02 starting frequency, enter zero speed running state

◇ F07.18: Positive reversal of dead time

Code (Addr.)	Name	Content	Factory setting (Setting range)
F07.18 (0x0712) STOP	Positive reversal dead time	V/F SVC When the forward and reverse switching is performed, the time is maintained at zero speed.	0.0s (0.0 ~ 120.0s)

When the forward/reverse command is switched, the zero frequency is entered into the positive and negative dead zone state, and the timing is started. The timing is cleared after exiting the positive and negative dead zone status.

Exit the positive and negative dead zone status:

Exit method	Control form after exit
Positive reversal of dead time to	Enter normal start control
Reverse command	Enter normal start control
Stop command	Enter shutdown control

During the process of reversing the dead zone state:

Control mode	Method to realize
Open loop vector, V/F	Zero speed torque is effective and enters zero speed torque control.
Open loop vector, V/F	The zero-speed torque is invalid, and the output frequency and voltage are all zero.
Closed loop vector	Zero speed control

Note:

- This function can be used at the site where the required process is required to be performed at zero speed for a certain time.
- The positive and negative dead zone states do not conflict with the zero-speed torque hold function, and all start timing at zero frequency.

F07.2x group: DC braking and speed tracking

◇ F07.20 ~ F07.21: Start DC braking

Code (Addr.)	Name	Content	Factory setting (Setting range)
F07.20 (0x0714) STOP	Start DC braking current	V/F SVC 100.0% corresponds to the rated current of the inverter	60.0% (0.0 ~ 150.0%)
F07.21 (0x0715) STOP	Start DC braking time	V/F SVC Set the time to start DC braking maintenance	0.0s (0.0 ~ 60.0s)

Note: This function is valid when F07.00 = 1 [Start mode = DC braking first, then start by starting frequency].

When the running command is valid, if there is no pre-excitation function, it will directly enter the starting DC braking state; if the pre-excitation function is valid, the pre-excitation is completed and the DC braking state is entered.

Start DC braking current

100.0% corresponds to the rated current of the inverter, but the starting DC braking current is limited by the rated current of the motor.

The DC braking current affects the magnetic field strength of the fixed motor shaft. Increasing the current value will increase the amount of heat generated by the motor. Set the minimum current required to fix the motor shaft.

Start DC braking time:

When the running command is valid, if there is no pre-excitation function, the timing starts; if the pre-excitation function is valid, the timing starts after the pre-excitation is completed.

Note:

- When restarting a motor that is running freely, use the start DC brake to stop the motor before restarting, or use the speed tracking to restart the motor.

◇ F07.22 ~ F07.24: DC brake at stop

Code (Addr.)	Name	Content	Factory setting (Setting range)
--------------	------	---------	---------------------------------

F07.22 (0x0716) STOP	Stop DC brake judgment frequency	V/F SVC Set the threshold for entering DC braking at stop	1.00Hz (0.0 ~ 50.00Hz)
F07.23 (0x0717) STOP	DC braking current at stop	V/F SVC 100.0% corresponds to the rated current of the inverter	60.0% (0.0 ~ 150.0%)
F07.24 (0x0718) STOP	DC braking time at stop	V/F SVC Set the time for stopping DC braking	0.0s (0.0 ~ 60.0s)

Note: DC braking at stop is valid only when F07.10 = 0 [stop mode = deceleration stop].

When there is a stop command and the output frequency is less than F07.22 [stop DC brake judgment frequency], the DC brake state is stopped.

After the stop DC braking is over, it enters the stop state.

When the running command is received during the stop DC braking state, the stop DC braking state is exited and the normal starting control is entered.

DC braking current at stop

100.0% corresponds to the rated current of the inverter, but the DC braking current at the stop is limited by the rated current of the motor.

The DC braking current affects the magnetic field strength of the fixed motor shaft. Increasing the current value will increase the amount of heat generated by the motor. Set the minimum current required to fix the motor shaft.

DC braking time at stop:

Start the stop DC braking state to start timing; exit the stop DC braking state, clear the timing, and enter the re-timer next time.

◇ ▣ F07.25 ~ F07.28: Speed tracking

Code (Addr.)	Name	Content	Factory setting (Setting range)
F07.25 (0x0719) STOP	Speed tracking mode	V/F SVC Set the mode of tracking tracking	0000 (0x0000 ~ 0x0111)
F07.26 (0x071A) STOP	Speed tracking speed	V/F SVC Set the speed of tracking	0.50 (0.00 ~ 60.00s)
F07.27 (0x071B) STOP	Speed tracking stop delay	V/F SVC Set the tracking delay for tracking tracking	1.00s (0.00 ~ 60.00s)
F07.28 (0x071C) STOP	Speed tracking current	V/F SVC Set the current limit for tracking tracking	120.0% (0.00 ~ 400.0%)

Note: This function is valid when F07.00 = 2 [Start mode = Speed tracking start].

Speed tracking mode:

Units: Search method

0: Search from the maximum frequency

1: Search from stop frequency

Ten: Reverse Search Selection

0: off

1: open

Note:

➤ After the reverse search is turned on, the motor may search for the reverse. Please do not enable this function when reverse operation is not allowed.

➤ The S/T2 model does not support the speed tracking start.

Speed tracking speed:

During the start of the inverter speed tracking, the output voltage is added to the normal voltage at the current speed. The shorter the time, the faster the tracking process, but the greater the current impact generated by the tracking process. Internal automatic control of tracking speed.

Speed tracking stop delay:

After the inverter cuts off the output, it takes a certain delay to re-output the voltage to start the motor, so that the inrush current at startup is as small as possible. When the time is zero, the delay is automatically controlled by the inverter.

F07.3x Group.: Jog

◇ F07.30: Jog frequency

Code (Addr.)	Name	Content	Factory setting (Setting range)

F07.30 (0x071E) RUN	Jog frequency	V/F SVC Set the given frequency when jogging	5.00Hz (0.00 ~ F01.10)
---------------------------	---------------	---	---------------------------

Note:

- The jog run command has a higher priority, and the jog command is valid during the running process and directly enters the jog control.
- The upper limit is set to be limited by F01.10 [maximum frequency].

◇ F07.31 ~ F07.32 jog acceleration and deceleration time

Code (Addr.)	Name	Content	Factory setting (Setting range)
F07.31 (0x071F) RUN	Jog acceleration time	V/F SVC Set the jog output frequency from 0 to F01.20 to select the acceleration time of the frequency	10.00s (0.01 ~ 650.00s)
F07.32 (0x0720) RUN	Jog deceleration time	V/F SVC Set the jog output frequency from F01.20 to select the frequency to 0 deceleration time	10.00s (0.01 ~ 650.00s)

Note:

- F01.20 =0, 1, 2 [Acceleration/deceleration time reference frequency = maximum frequency, fixed frequency 50.00 Hz, set frequency].
- The upper limit is set to be limited by F01.10 [maximum frequency].

◇ ▮ F07.33: Jog S curve selection

Code (Addr.)	Name	Content	Factory setting (Setting range)
F07.33 (0x0721) RUN	Jog S curve selection	V/F SVC Set whether the S curve is valid when jogging	0 (0 ~ 1)

0: invalid
1: valid

Note:

- The jog S curve time is the same as the non-jog S curve, and both are F01.31~F01.34.

◇ F07.34: Jog stop mode

Code (Addr.)	Name	Content	Factory setting (Setting range)
F07.33 (0x0722) RUN	Jog stop mode	V/F SVC Set the way of jog down	0 (0 ~ 1)

0: Stop mode set with F07.10

F07.10=0[stop mode=deceleration stop];

F07.10=1[stop mode=free stop].

1: Deceleration only

The stop mode is not affected by the F07.10 setting, only the deceleration stop.

Note:

- When jog only deceleration stop mode, it does not enter the stop DC braking, nor does it enter the shutdown maintenance frequency judgment.
- The start of the maintenance frequency function when jogging is invalid.
- The jog frequency reference is not limited by the lower limit frequency.

F07.4x Group: Start, stop, maintain frequency and frequency jump

◇ ▮ F07.40 ~ F07.43: Start, stop and maintain frequency

Start and stop frequency maintenance function, that is, the function of temporarily maintaining the set output frequency when starting or stopping.

Use this feature to prevent the motor from stalling when the load is started or stopped. Moreover, this function prevents mechanical backlash from causing an impact at the start of acceleration and deceleration.

When accelerating, the inverter runs at a low speed with the set output frequency and time to reduce the influence of the gear gap and then accelerate. The same effect is achieved when decelerating.

When applied to a handling machine, it can be used to wait for the opening and closing delay of the electromagnetic brake on the mechanical or motor side for the output frequency of the inverter.

Code (Addr.)	Name	Content	Factory setting (Setting range)
--------------	------	---------	---------------------------------

F07.40 (0x0738) STOP	Startup maintenance frequency	V/F SVC Set the output frequency temporarily held when the motor starts.	0.50Hz (0.00 ~ F01.12)
F07.41 (0x0739) STOP	Start maintenance frequency time	V/F SVC Set the time of the output frequency temporarily held when the motor starts.	0.00s (0.00 ~ 60.00s)

When starting the acceleration, when the output frequency reaches the frequency set by F07.40, the inverter maintains this frequency and continues to start the acceleration after the time set in F07.41.

Note:

- The start of the maintenance frequency function when jogging is invalid.

Code (Addr.)	Name	Content	Factory setting (Setting range)
F07.42 (0x073A) STOP	Shutdown maintenance frequency	V/F SVC Set the output frequency temporarily held when the motor starts.	0.50Hz (0.00 ~ F01.12)
F07.43 (0x073B) STOP	Stop maintenance frequency time	V/F SVC Set the time of the output frequency temporarily held when the motor starts.	0.00s (0.00 ~ 60.00s)

When the output frequency reaches the frequency set by F07.42 during stop deceleration, the inverter maintains this frequency and continues to decelerate after the time set in F07.43.

Note:

- When jog only deceleration stop mode, it does not enter the stop DC braking, nor does it enter the shutdown maintenance frequency judgment.

◇ ¶ F07.44 ~ F07.47: Jump frequency

The hopping frequency is a function of setting a dead band for a specific frequency band. Resonance may occur when a variable speed operation is performed on a machine that has been operating at a constant speed. To avoid resonance caused by the natural vibration frequency of the mechanical system during operation, it is necessary to skip a specific frequency band.

The jump frequency can be set up to 2 places. Set the center value of the frequency to be skipped by F07.44, F07.46 [jump frequency 1, 2], and set the frequency range by F07.45, F07.47 [jump frequency amplitude 1, 2].

When the input frequency command is the same as or close to the skip frequency band, the frequency command is automatically changed. Allow the motor to accelerate or decelerate smoothly until the frequency command exceeds the range of the skip frequency band. The acceleration/deceleration rate at this time is determined by the effective setting of the acceleration/deceleration time. When the frequency command reaches the range of the skip frequency band, it will switch to constant speed operation.

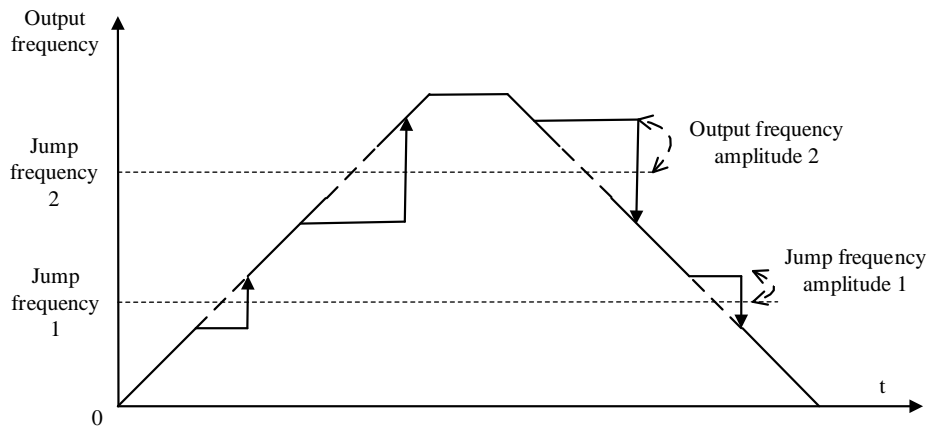

Schematic diagram of the frequency of the jump

Code (Addr.)	Name	Content	Factory setting (Setting range)
F07.44 (0x073C) RUN	Jump frequency 1	V/F SVC Set the center value of the specific frequency band to jump	0.00Hz (0.00 ~ F01.10)
F07.45 (0x073D) RUN	Jump frequency amplitude 1	V/F SVC Set the amplitude of the specific frequency band to jump	0.00Hz (0.00 ~ F01.10)

Note:

- F07.44 [Jumping frequency 1] is set to 0.00Hz, and the skip frequency 1 is invalid.

Code (Addr.)	Name	Content	Factory setting (Setting range)
--------------	------	---------	---------------------------------

F07.46 (0x073E) RUN	Jump frequency 2	V/F SVC Set the center value of the specific frequency band to jump	0.00Hz (0.00 ~ F01.10)
F07.47 (0x073F) RUN	Jump frequency amplitude 2	V/F SVC Set the amplitude of the specific frequency band to jump	0.00Hz (0.00 ~ F01.10)

Note:

- F07.46[Jumping frequency 2] is set to 0.00Hz, and the skip frequency 2 is invalid.

11.10 F08 Group: Auxiliary Control 1

F08.0x group: counting and timing

Count

Related setting parameters when applying this function:

Parameter	Name	Factory setting	Features
F05.0x	Multi-function input terminal	42	Counter signal input
F05.0x	Multi-function input terminal	43	Count value is cleared
F06.21~F06.24	Multi-function output terminal	22	Count value reaches the maximum value
F06.21~F06.24	Multi-function output terminal	23	Count value reaches the set value
C00.22	Count value		

◇ ¶ F08.00: Counter input source

Code (Addr.)	Name	Content	Factory setting (Setting range)
F08.00 (0x0800) RUN	Timer input source	V/F SVC Set the input source of the internal timer of the inverter	0 (0 ~ 2)

0: Normal multi-function input terminal The frequency of the input signal is less than 100Hz.

1: Input terminal PUL The upper frequency limit of the input signal is determined by F05.30.

2: Reserved

Note:

- When selecting a different input source, be aware of the upper frequency limit of the signal.
- When F08.00 = 0 mode, the input signal should be used in conjunction with the F05.0x = 42 [multi-function input terminal = counter input terminal] setting terminal.

◇ ¶ F08.01: Counting frequency division

Code (Addr.)	Name	Content	Factory setting (Setting range)
F08.01 (0x0801) RUN	Counting frequency	V/F SVC Set the count frequency	0 (0~ 6000)

The monitoring parameter C00.22 [count value] is obtained by dividing the count signal.

Note:

- The values compared with F08.02 [Timer Max] and F08.03 [Timer Set] are the count values in C00.22.

◇ F08.02: Counter maximum

Code (Addr.)	Name	Content	Factory setting (Setting range)
F08.02 (0x0802) RUN	Counter maximum	V/F SVC Set the maximum value of the counter.	1000 (0~ 6500)

F06.21~F06.24=22[Multi-function output terminal=Counter reaches the maximum value], when the count value reaches the value set by F08.02, the corresponding output terminal outputs a valid signal, and the C00.22 count value is cleared. zero. The output signal width is equal to the clock period of the valid signal of the external input terminal, that is, when the next count signal is input, the output terminal stops outputting the valid signal.

◇ ¶ F08.03: Counter setting value

Code (Addr.)	Name	Content	Factory setting (Setting range)
F08.03 (0x0803) RUN	Counter setting	V/F SVC Set the counter setting value.	500 (0~ 6500)

F06.21~F06.24=23[Multi-function output terminal=Counter reaches the set value], when the count value reaches the value set by F08.03, the valid signal is output at the corresponding output terminal, and the output signal width is the count value. When the value specified by parameter F08.02 is exceeded, the output terminal stops outputting a valid signal when the counter is cleared.

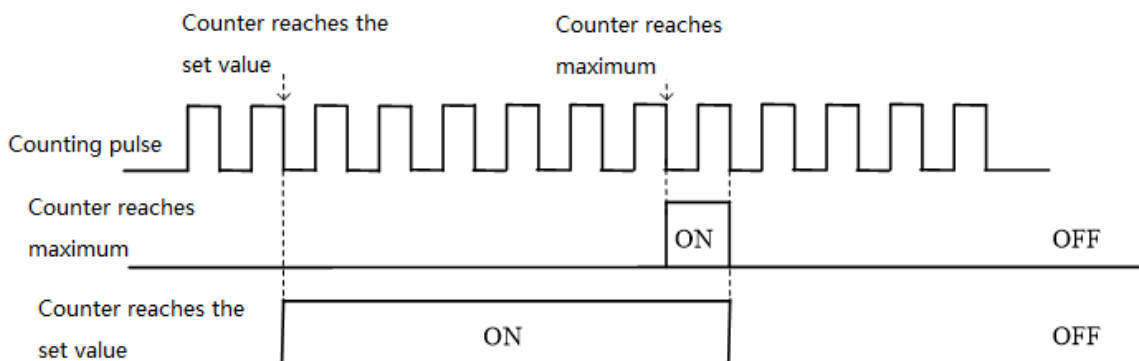

Counter maximum value and counter setting value related operation diagram

Note:

- The counter set value is required to be less than or equal to the timer maximum.
- The count value of C00.22 can be cleared by the terminal set by F05.0x = 43 [multi-function input terminal = counter clear].

Fixed length control

F08.06 [Actual length] = C00.22/F08.04.

When F08.06 [actual length] is greater than or equal to F08.05 [set length], the output signal can be output through the F6.21~F06.42=20[multi-function output terminal = meter length] output terminal for stop control or the next action starts the control.

◇ F08.04: Pulse number per meter

Code (Addr.)	Name	Content	Factory setting (Setting range)
F08.04 (0x0804) RUN	Pulse number per meter	V/F SVC Set the number of pulses per meter	10.0 (0.1~ 6500.0)

◇ F08.05: set length

Code (Addr.)	Name	Content	Factory setting (Setting range)
F08.05 (0x0805) STOP	Set length	V/F SVC Set length	500 (0~ 65000M)

Note:

- The set value of the set length should pay attention to its range and cannot exceed the calculated value of F08.02 /F08.04.

◇ F08.06: Actual length

Code (Addr.)	Name	Content	Factory setting (Setting range)
F08.06 (0x0806) STOP	Actual length	V/F SVC Set the actual length. This parameter is a read-only parameter	500 (0~ 65000M)

Note: F08.06[Actual length] = C00.22/F08.04.

Timer

The timer starts counting from the external trigger terminal receiving a valid signal. After the timing time arrives, the pulse signal with a width of 1 second is output from the corresponding output terminal.

When the trigger terminal is invalid, the timer keeps the existing timing value, and the accumulated timing continues after the trigger terminal is valid.

The timer timing clear terminal can clear the timing value at any time.

Related setting parameters when applying this function:

Parameter	Name	Factory setting	Features
F05.0x	Multi-function input terminal	40	Timer timing trigger
F05.0x	Multi-function input terminal	41	Timer timing clear
F06.21~F06.24	Multi-function output terminal	21	Timer time arrives

C00.30	Timer timing		
--------	--------------	--	--

◇ ▯ F08.07: Timer time unit

Code (Addr.)	Name	Content	Factory setting (Setting range)
F08.07 (0x0807) STOP	Timer time unit	V/F SVC Set timer time unit	0 (0 ~2)

0: second
1: point
2: hour

◇ F08.08: Timer setting value

Code (Addr.)	Name	Content	Factory setting (Setting range)
F08.08 (0x0808) STOP	Timer setting	V/F SVC Set the timer setting	0 (0 ~65000)

F08.1x group: reserved

F08.2x Group: Reserved

F08.3x group: swing frequency control

During the swing frequency operation, the inverter periodically changes the output frequency with a preset acceleration/deceleration time. This function is especially suitable for systems such as the textile industry that vary the rotational speed depending on the front and rear diameters of the bobbin.

◇ ▯ F08.30: Swing frequency control

Code (Addr.)	Name	Content	Factory setting (Setting range)
F08.30 (0x081E) STOP	Swing frequency control selection	V/F SVC Select whether swing frequency control is on	0 (0 ~ 1)

0: off
1: open

◇ F08.31: Swing frequency control selection

Code (Addr.)	Name	Content	Factory setting (Setting range)
F08.31 (0x081F) STOP	Swing frequency control selection	V/F SVC Select the swing frequency control method	0x0000 (0x0000~ 0x0111)

Units: Startup mode
0: automatic
1: terminal manual
Ten digits: pendulum amplitude control
0: Relative center frequency
1: Relative maximum frequency
Hundreds place: preset frequency enable
0: not enabled
1: enable
Thousands: reserved

◇ ▯ F08.32: swing frequency preset frequency

Code (Addr.)	Name	Content	Factory setting (Setting range)
F08.32 (0x0820) STOP	Swing frequency preset frequency	V/F SVC Swing frequency preset frequency	0.00Hz (0.00 ~ F01.12)

◇ F08.33: Swing frequency preset frequency waiting time

Code (Addr.)	Name	Content	Factory setting (Setting range)

F08.33 (0x0821) STOP	Swing frequency preset frequency waiting time	V/F SVC Swing frequency preset frequency waiting time	0.0 (0.0 ~ 3600.0s)
----------------------------	--	--	------------------------

◇ F08.34: Wobble amplitude

Code (Addr.)	Name	Content	Factory setting (Setting range)
F08.34 (0x0822) STOP	Swing frequency amplitude	V/F SVC Set the swing frequency amplitude	10.0% (0.0 ~ 50.0%)

◇ F08.35: Kick frequency

Code (Addr.)	Name	Content	Factory setting (Setting range)
F08.35 (0x0823) STOP	Kick frequency	V/F SVC Set the kick frequency	10.0% (0.0 ~ 50.0%)

◇ F08.36: Triangle wave rise time

Code (Addr.)	Name	Content	Factory setting (Setting range)
F08.36 (0x0824) STOP	Triangle wave rise time	V/F SVC Set the triangle wave rise time	5.00s (0.0 ~ 650.00s)

◇ F08.37: Triangle wave fall time

Code (Addr.)	Name	Content	Factory setting (Setting range)
F08.37 (0x0825) STOP	Triangle wave fall time	V/F SVC Set the triangle wave fall time	5.00s (0.0 ~ 650.00s)

11.11 F09 Group: Reserved

11.12 F10 Group: Protection parameters

F10.0x group: current protection

Code (Addr.) Adjustable attribute	Name	Content	Factory setting (Setting range)
F10.00 (0x0A00) RUN	Overcurrent suppression	V/F SVC Automatically limit the output current to not exceed the set overcurrent suppression point to prevent overcurrent and trigger overcurrent fault 0: Inhibition is always valid 1: Acceleration/deceleration is valid, constant speed is invalid	0 (0 ~ 1)

Note: This function code selection is valid only for the VF control mode, and the overcurrent suppression function for vector control is always valid.

0: Inhibition is always valid

When the inverter reaches the overcurrent suppression point when the inverter is adding, subtracting and constant speed, the inverter reduces the output current through software control (pause acceleration, deceleration, lowering or raising the output frequency, etc.), and the output current is reduced to overcurrent suppression. When the point is below, the inverter works normally.

1: Acceleration/deceleration is valid, constant speed is invalid

The overcurrent suppression function is valid during the acceleration/deceleration of the inverter, and the overcurrent suppression is invalid at constant speed.

Note: In the case of constant speed operation, the flow fault may be reported when the load changes too much.

Code (Addr.) Adjustable attribute	Name	Content	Factory setting (Setting range)
F10.01 (0x0A01) RUN	Overcurrent suppression point	V/F SVC Set the load current limit level, 100% corresponds to the rated motor current	160.0% (0.0 ~ 300.0%)

Set the load current limit level of the overcurrent suppression function, 100% corresponds to the motor rated current, and the output current ratio is greater than this value, triggering the overcurrent suppression function.

Code (Addr.) Adjustable attribute	Name	Content	Factory setting (Setting range)
--------------------------------------	------	---------	---------------------------------

F10.02 (0x0A02) RUN	Overcurrent suppression gain	V/F SVC Set the response effect of overcurrent suppression. 100.0% corresponds to the rated current of the motor	100.0% (0.0 ~ 500.0%)
---------------------------	---------------------------------	--	--------------------------

Adjust the corresponding speed of the overcurrent suppression function.

Code (Addr.) Adjustable attribute	Name	Content	Factory setting (Setting range)
F10.03 (0x0A03) STOP	Current protection setting 1	V/F SVC Set whether the current related protection function is turned on. Unit: Wave-by-wave current limit (CBC) 0: off 1: on Tens: OC protection interference suppression 0: normal 1: Primary interference suppression 2: Secondary interference suppression Hundreds place: SC protection interference suppression 0: normal 1: Primary interference suppression 2: Secondary interference suppression Thousands: reserved	0001 (0000-0221)
F10.04 (0x0A04) STOP	Current protection setting 2	V/F SVC Unit: Reserved 0: off 1: on	0001 (0000-0001)

Set whether the current related protection function is turned on.

Unit: Wave-by-wave current limit (CBC)

The wave-by-wave current limiting function protects the rise of the current to a certain extent through hardware protection, and avoids the inverter over-current fault.

0: off

1: open

Tens: OC protection interference suppression

When this function is enabled, the software judges E.OC [overcurrent fault], eliminates the interference signal, and only responds to the true overcurrent signal. After the secondary interference suppression is turned on, all the edge information will be filtered.

0: normal

1: Primary interference suppression

2: Secondary interference suppression

Note: This function may delay the alarm time of overcurrent faults, please use with caution.

Hundreds place: SC protection interference suppression

When this function is valid, the software judges E.SC [system fault], eliminates the interference signal, and only responds to the true system fault signal. After the second-level interference suppression is turned on, all the edge information will be filtered.

0: normal

1: Primary interference suppression

2: Secondary interference suppression

Note: This function may delay the alarm time of system failure, please use it with caution.

Thousands: reserved

Code (Addr.) Adjustable attribute	Name	Content	Factory setting (Setting range)
F10.04 (0x0A04) STOP	Current protection setting 2	V/F SVC Unit position: three-phase current detection and non-zero judgment, output failure E.HAL 0: off 1: on	0001 (0000-0001)

F10.1x Group: Voltage protection

Code (Addr.) Adjustable attribute	Name	Content	Factory setting (Setting range)
F10.10 (0x0A0A) STOP	Bus overvoltage hardware protection	V/F SVC Set whether the bus overvoltage hardware protection function is enabled. 0: off 1: on	0 (0 ~ 1)

Code (Addr.) Adjustable attribute	Name	Content	Factory setting (Setting range)

F10.11 (0x0A0B) STOP	Bus overvoltage suppression	V/F SVC When the bus voltage is greater than the overvoltage suppression point, it will slow down or stop the acceleration and deceleration to prevent overvoltage faults. Unit position: Overvoltage suppression function 0: off 1: only open when decelerating 2: Both open and decelerate Ten digits: overexcitation function 0: off 1: on	0012 (0000 ~0012)
----------------------------	--------------------------------	---	----------------------

Note: The overvoltage suppression function is valid for any control mode. When the regenerative load suddenly becomes large, E.OU [overvoltage fault] may be reported even if the overvoltage suppression function is turned on.

Unit position: Overvoltage suppression function

0: off

When the bus voltage is greater than the overvoltage suppression point, the output frequency is not adjusted, and E.OU [overvoltage fault] may be triggered.

1: only open when decelerating

The overvoltage suppression function is only effective in the case of deceleration.

2: Both open and decelerate

The overvoltage suppression function is effective in both the acceleration and deceleration conditions. This setting is especially effective for eccentric loads.

Ten digits: overexcitation function

0: off

The excitation current is not increased during deceleration, and the overexcitation function is invalid.

1: open

Over-excitation deceleration increases the excitation current during deceleration and places the motor in an overexcited state, generating a large braking torque that causes the motor to decelerate more rapidly than the normal deceleration stop.

Precautions when using overexcitation deceleration:

Do not use the overexcitation deceleration function for the following purposes. It is recommended to connect the brake resistor.

- frequent rapid deceleration
- continuous regenerative load
- low inertia machinery
- Machinery that does not allow torque fluctuations

Code (Addr.) Adjustable attribute	Name	Content	Factory setting (Setting range)
F10.12 (0x0A0C) STOP	Bus overvoltage suppression point	V/F SVC Set bus voltage value for trigger overvoltage suppression function Remarks: T3 overvoltage point: 820V (750 ~ 840) S2 overvoltage point: 400V (360 ~ 410)	T3: 780 S2: 370 (T3: 650 ~760 S2: 340 ~380) Also subject to overpressure limit

Note: The factory value of this parameter is determined by the inverter model.

When the bus voltage reaches or exceeds F10.12 [bus overvoltage suppression point] during the running of the inverter, the output frequency is automatically adjusted to suppress the bus voltage from rising, avoiding the inverter jumping E.OU [overvoltage fault], the overvoltage suppression function diagram As shown below.

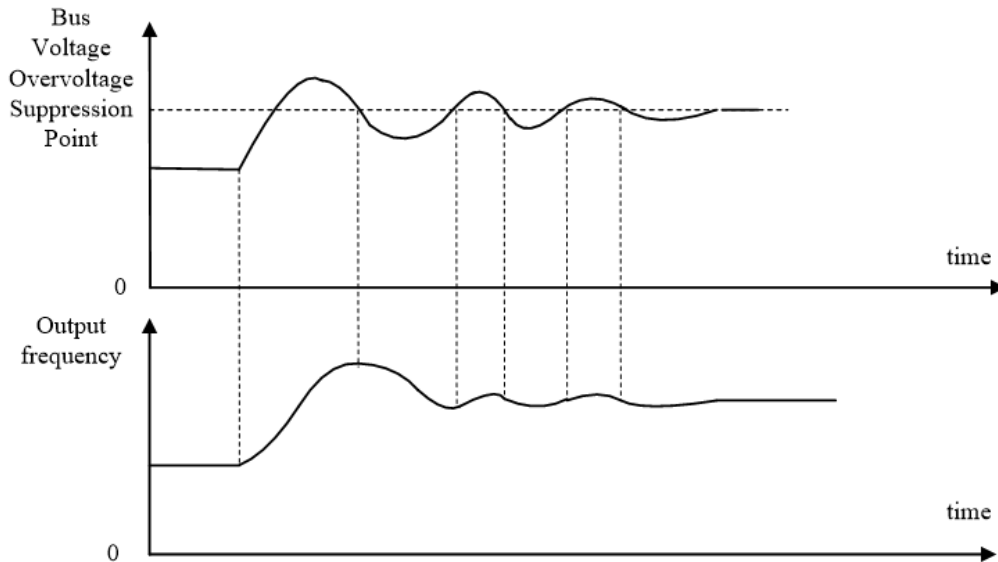

Overvoltage suppression function diagram

Code (Addr.) Adjustable attribute	Name	Content	Factory setting (Setting range)
F10.13 (0x0A0D) RUN	Bus overvoltage suppression gain	Set the response of overvoltage suppression	100.0% (0.0~500.0%)

Adjust F10.13 [Bus Overvoltage Suppression Gain] to adjust the effect of the overvoltage suppression function. When this parameter is set to 0, the overvoltage suppression function is turned off.

Code (Addr.) Adjustable attribute	Name	Content	Factory setting (Setting range)
F10.14 (0x0A0E) RUN	Energy brake enable	V/F SVC Set whether the energy brake function is on 0: off 1: Turn on, but turn off the overvoltage suppression function 2: Turn on, and turn on the overvoltage suppression function.	2 (0~2)

This parameter sets whether the energy brake function is turned on.

0: Off No matter the bus voltage, the inverter does not control the energy consumption of the motor.

1: Turn on the energy brake and turn off the overvoltage suppression function. When the bus voltage exceeds the energy consumption braking action voltage, the inverter performs dynamic braking control on the motor, and the overvoltage suppression function is turned off at this time.

2: At the same time, the energy consumption braking and overvoltage suppression function is enabled, the bus voltage exceeds the energy consumption braking action voltage, the inverter performs the energy consumption braking control on the motor, and the overvoltage suppression function is activated at the same time.

Code (Addr.) Adjustable attribute	Name	Content	Factory setting (Setting range)
F10.15 (0x0A0F) RUN	Energy consumption braking action voltage	V/F SVC Set the energy consumption braking action voltage, when the bus voltage is greater than this value, the energy consumption brake starts to act. Remarks: T3 overvoltage point: 820V (750 ~ 840) S2 overvoltage point: 400V (360 ~ 410)	T3: 740 S2: 360 (T3: 650 ~800 S2: 350 ~390) 同时受过压点限制

When the inverter DC bus voltage rises and exceeds F10.15 [energy braking action voltage], the inverter energy consumption braking starts. For models without a built-in braking resistor, an additional braking resistor is required to use the dynamic braking function.

Note: When using the energy consumption braking function, please turn off the overvoltage suppression function and set F10.11 to 0; otherwise, overvoltage suppression may inhibit the rise of the bus voltage and fail to reach the braking action point.

Code (Addr.) Adjustable attribute	Name	Content	Factory setting (Setting range)
F10.16 (0x0A10) STOP	Bus undervoltage suppression	V/F SVC When the bus voltage is lower than the undervoltage suppression point, the operating frequency is automatically adjusted to suppress the bus voltage from decreasing, preventing the undervoltage fault. 0: off 1: on	0 (0 ~ 1)

Note: Overvoltage suppression is valid for any control method.

When the bus voltage during the running of the inverter reaches or falls below F10.17 [bus undervoltage suppression point], the inverter will automatically adjust the operating frequency to suppress the bus voltage drop, thus ensuring that the inverter does not trigger E.LU2 due to the low bus voltage. [Undervoltage fault].

0: off

1: open

Code (Addr.) Adjustable attribute	Name	Content	Factory setting (Setting range)
F10.17 (0x0A11) STOP	Bus undervoltage suppression point	V/F SVC Set the bus voltage value for the trigger undervoltage suppression function. Remarks: T3 overvoltage point: 820V (750 ~ 840) S2 overvoltage point: 400V (360 ~ 410)	T3: 430 S2: 240 (T3: 350 ~450 S2: 180 ~260) 同时受过压点限制

Note: The factory value of this parameter is determined by the inverter model.

When the bus voltage during the running of the inverter reaches or falls below F10.17 [bus undervoltage suppression point], the inverter will automatically adjust the operating frequency to suppress the bus voltage drop, thus ensuring that the inverter does not trigger E.LU2 due to the low bus voltage. [Undervoltage fault].

Code (Addr.) Adjustable attribute	Name	Content	Factory setting (Setting range)
F10.18 (0x0A12) RUN	Bus undervoltage suppression gain	V/F SVC Set the response effect of undervoltage suppression	100.0% (0.0 ~500.0%)

Adjust F10.18 [Bus Undervoltage Suppression Gain] to adjust the effect of the undervoltage suppression function. When this parameter is set to 0, the undervoltage suppression function is turned off.

Code (Addr.) Adjustable attribute	Name	Content	Factory setting (Setting range)
F10.19 (0x0A13) STOP	Bus undervoltage protection point	V/F SVC The lower limit voltage allowed by the set bus voltage. Below this value, the inverter reports an undervoltage fault. Remarks: T3 overvoltage point: 820V (750 ~ 840) S2 overvoltage point: 400V (360 ~ 410)	T3: 320 S2: 190 (T3: 300 ~400 S2: 160 ~240) Also subject to overpressure limit

This parameter specifies the lower limit voltage allowed by the bus voltage when the inverter is working normally. For some occasions where the grid is low, the undervoltage protection level can be appropriately reduced to ensure the normal operation of the inverter.

Note: When the grid voltage is too low, the output torque of the motor will decrease. For constant power loads and constant torque loads, too low grid voltage will increase the input and output current of the inverter, thus reducing the reliability of the inverter operation.

F10.2x group: auxiliary protection

Code (Addr.) Adjustable attribute	Name	Content	Factory setting (Setting range)
---	------	---------	------------------------------------

F10.20 (0x0A14) STOP	Input and output phase loss protection options	V/F SVC Set whether the input and output phase loss protection functions are enabled. Unit: Output phase loss protection 0: off 1: on Ten digits: input phase loss protection 0: off 1: On, detected the input missing phase report warning A.ILF, continue to run 2: Turn on, detect input missing phase report fault E.ILF, free stop	021 (000 ~ 121)
----------------------------	--	---	--------------------

Set whether the input and output phase loss protection functions are enabled.

Unit: Output phase loss protection function selection

0: Off, the output phase loss protection function is invalid.

1: On, the output phase loss protection function is valid, and the fault E.OLF is reported when the output phase loss is detected, and the motor is free to stop.

Ten digits: input phase loss protection function selection

0: Off, the input phase loss protection function is invalid.

1: On, the input missing phase report warning A.ILF is detected, and the motor continues to run.

2: Turn on, detect the input missing phase report fault E.ILF, the motor is free to stop.

Code (Addr.) Adjustable attribute	Name	Content	Factory setting (Setting range)
F10.21 (0x0A15) STOP	Input phase loss threshold	V/F SVC Set the percentage of voltage detection of the input phase loss detection function, 100% corresponds to the rated bus voltage	10% (0 ~30.0%)

The percentage of the voltage detection of the set input phase loss detection function, 100% corresponds to the rated bus voltage.

Note: This value can be appropriately increased when the grid motor fluctuates greatly to prevent false alarms from entering the phase loss warning.

Code (Addr.) Adjustable attribute	Name	Content	Factory setting (Setting range)
F10.22 (0x0A16) STOP	Ground short circuit protection option	V/F SVC Set whether the inverter output and the inverter cooling fan ground short circuit protection function are enabled. Unit: Output short circuit protection 0: off 1: on Tens: fan short to ground protection 0: off 1: on	11 (00 ~12)

Set whether the inverter output and the inverter cooling fan ground short circuit protection function are enabled.

Unit: Output short circuit protection

0: Off, the output short circuit protection function is turned off.

1: On, the output short circuit protection function is turned on. When the inverter output is shorted to ground, it is reported to E.SG [output short to ground fault].

Tens: fan short to ground protection

0: Off, the fan short to ground protection function is turned off.

1: On, the fan short-to-ground protection function starts. When the fan is short-circuited to ground, it reports E.FSG [Fan-to-ground short-circuit fault].

Note:

- When the start-to-ground short-circuit detection is turned on, the synchronous machine cannot be started in rotation.

Code (Addr.) Adjustable attribute	Name	Content	Factory setting (Setting range)
F10.23 (0x0A17) RUN	Fan ON/OFF control selection	V/F SVC Set the inverter cooling fan operation mode 0: The fan runs after the inverter is powered on. 1: After the shutdown, the fan operation is related to temperature, and the operation is running. 2: After the shutdown, the fan stops after F10.24, and the operation is related to temperature.	1 (0~2)

Set the inverter cooling fan to operate.

0: The fan runs after the inverter is powered on. Regardless of the module temperature, the fan will run after the inverter is powered on.

1: Shutdown is related to temperature, and the operation is running. When the inverter is stopped, the fan is running and the module temperature is related. The temperature exceeds 50 degrees Celsius and the fan runs. Otherwise, the fan stops after 30 seconds delay. The inverter runs for 1s and delays the fan.

2: The shutdown fan stops, the operation is related to the temperature. Whether the fan is running is related to the module temperature when the inverter is running. If the temperature exceeds 50 degrees Celsius, the fan will run immediately, otherwise the fan will stop after 30 seconds delay. The fan stops running after a delay of 30s during shutdown.

Tip: Proper use of this feature will effectively extend the life of the cooling fan.

Code (Addr.) Adjustable attribute	Name	Content	Factory setting (Setting range)
F10.24 (0x0A18) STOP	Fan control delay time	V/F SVC Set the time from when the run command is canceled to when the cooling fan stops running.	30.00s (0 ~600.00)

Set the time from the release of the running command to the stop of the cooling fan. After the inverter stops running, the fan will stop running after this time.

Code (Addr.) Adjustable attribute	Name	Content	Factory setting (Setting range)
F10.25 (0x0A19) RUN	Inverter overheating oH1 warning detection level	V/F SVC Set the temperature value of the inverter overheat warning, which is greater than the value to report the overheat warning.	80.0°C (0 ~100.0)

Set the temperature value of the inverter overheat warning. The heatsink temperature is greater than this value and report A.OH1 [overheat warning].

F10.3x group: load protection

Code (Addr.) Adjustable attribute	Name	Content	Factory setting (Setting range)
F10.30 (0x0A1E) STOP	Motor overload protection curve coefficient	V/F SVC Set the coefficient of overload protection for the load motor. Increasing this value can increase the overload capacity of the motor.	100.0% (0 ~250.0%)

The motor will be seriously heated when it is overloaded for a long time. F10.30 sets the coefficient of overload protection or thermal protection of the load motor to the load motor. The motor overload protection and motor current have inverse time characteristic curve. The overload protection curve when F10.30=100.0% as follows.

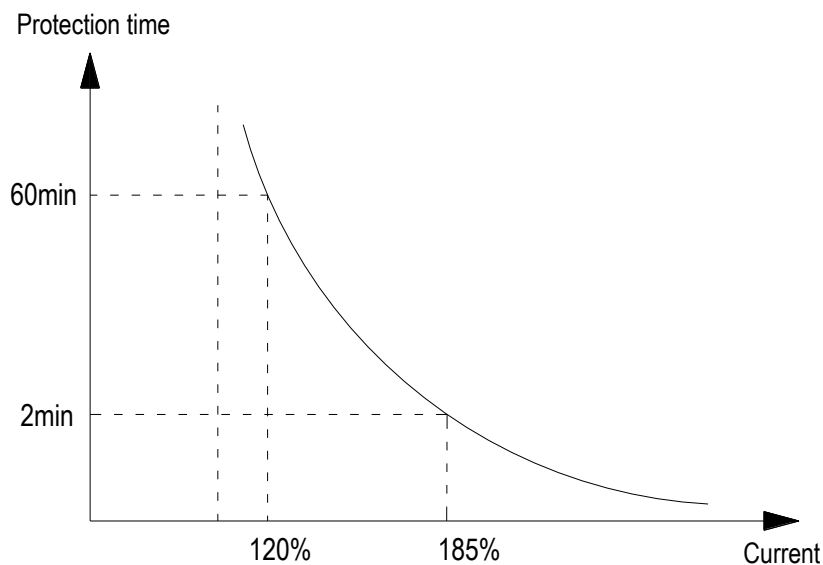

In the above figure, the horizontal axis is the current entering the protection curve, that is, the percentage of the rated current of the motor. The calculation formula is: horizontal axis current = (motor actual current / motor overload protection coefficient) × 100%, so increasing F10.30 can improve the motor Overload capability.

F10.30 sets the motor overload warning coefficient. When the motor overload level reaches the coefficient set by F10.30 and the Y terminal

function is selected as 27 [overload pre-alarm output 1], the inverter outputs the warning signal through the Y terminal.

Note: The user needs to correctly set the value of F10-30 according to the actual overload capacity of the motor. If the parameter is set too large, the motor may be overheated and the inverter will not be alarmed in time.

When one inverter is connected with multiple motors in parallel, the thermal relay protection function of the inverter will be disabled. In order to effectively protect the motor, install a thermal protection relay at the incoming end of each motor.

Code (Addr.) Adjustable attribute	Name	Content	Factory setting (Setting range)
F10.31 (0x0A1F) STOP	Selection of inverter overload characteristics at low speed	V/F SVC When the low speed (less than 5Hz) is set, the overload protection function of the inverter is valid. 0: Invalid 1: Valid	0 (0 ~1)

Note: When this function is enabled, if the inverter is frequently operated in the low speed range if the output current is too large, the IGBT module inside the inverter will shorten the service life due to thermal fatigue.

0: Invalid. The overload protection function is invalid at low speed (below 5 Hz).

1: Valid, the overload protection function is valid at low speed (below 5 Hz).

Code (Addr.) Adjustable attribute	Name	Content	Factory setting (Setting range)
F10.32 (0x0A20) STOP	Load warning checkout setting	V/F SVC Set the inverter load warning detection mode and the early warning mode at this time. Unit: Load warning checkout 1 setting 0: no detection 1: Detection load is too large 2: Excessive load detection only at constant speed 3: Insufficient detection load 4: Insufficient load detection only at constant speed Ten digits: warning setting when load warning is detected 1 0: continue to run, report A.LD1 1: Free stop, reported to E.LD1 Hundreds place: load warning checkout 2 setting 0: no detection 1: Detection load is too large 2: Excessive load detection only at constant speed 3: Insufficient detection load 4: Insufficient load detection only at constant speed Thousands: warning setting when load warning is detected 2 0: continue to run, report A.LD1 1: Free stop, reported to E.LD1	0000 (0000 ~1414)

Set the inverter load warning detection mode and the early warning mode at this time, and use the two parameters of load detection level and load warning detection time.

Unit: Load warning checkout 1 setting

0: no detection

1: Detection load is too large

2: Excessive load detection only at constant speed

3: Insufficient detection load

4: Insufficient load detection only at constant speed

Ten digits: warning setting when load warning is detected 1

0: continue to run, report A.LD1

1: Free stop, reported to E.LD1

Hundreds place: load warning checkout 2 setting

0: no detection

1: Detection load is too large

2: Excessive load detection only at constant speed

3: Insufficient detection load

4: Insufficient load detection only at constant speed

Thousands: warning setting when load warning is detected 2

0: continue to run, report A.LD1

1: Free stop, reported to E.LD1

Code (Addr.) Adjustable attribute	Name	Content	Factory setting (Setting range)
F10.33 (0x0A21) STOP	Load warning detection level 1	V/F SVC Set the detection value of load warning 1 When VF is controlled, this value is 100% corresponding to the rated current of the motor. When vector control, this value corresponds to 100% of the rated output torque of the motor.	130.0% (0 ~200.0%)
F10.34 (0x0A22) STOP	Load warning detection time 1	V/F SVC Set the duration of the detected load warning 1 and the load is greater than the load warning detection level for the duration, and the load warning is detected.	5.0s (0 ~60.0)

Set the load warning 1 related parameters.

In the VF control mode, the motor output current is used as the load warning judgment value, 100.0% corresponds to the rated motor current; in the vector control mode, the motor output torque is used as the load warning judgment value, and 100.0% corresponds to the rated output torque of the motor.

The load warning judgment value 1 is compared with F10.33 [load warning detection level] in F10.34 [load warning detection time], and is set according to F10.32 [load warning detection setting] and tens place. The value acts accordingly.

When the Y terminal function is selected as 27 [Overload pre-alarm output 1], the inverter outputs an early warning signal through the Y terminal.

Code (Addr.) Adjustable attribute	Name	Content	Factory setting (Setting range)
F10.35 (0x0A23) STOP	Load warning detection level 2	V/F SVC Set the detection value of load warning 2 When VF is controlled, this value is 100% corresponding to the rated current of the motor. When vector control, this value corresponds to 100% of the rated output torque of the motor.	130.0% (0 ~200.0%)
F10.36 (0x0A24) STOP	Load warning detection time 2	V/F SVC Set the duration of the detected load warning 2, the load is greater than the load warning detection level and continue for that time, and the load warning is detected 2	5.0s (0 ~60.0)

Set the load warning 2 related parameters.

In the VF control mode, the motor output current is used as the load warning judgment value, 100.0% corresponds to the rated motor current; in the vector control mode, the motor output torque is used as the load warning judgment value, and 100.0% corresponds to the rated output torque of the motor.

The load warning judgment value 2 is compared with F10.35 [load warning detection level] in F10.36 [load warning detection time], according to F10.32 [load warning detection setting] hundred and thousands setting The value acts accordingly.

When the Y terminal function is selected as 28 [Underload pre-alarm output 2], the inverter outputs an early warning signal through the Y terminal.

F10.4x group: stall protection

Code (Addr.) Adjustable attribute	Name	Content	Factory setting (Setting range)
F10.40 (0x0A28) STOP	Speed deviation too large protection action	V/F SVC Set the warning detection mode selection and alarm mode selection when the motor reference speed and feedback speed deviation are too large Unit: Check out the selection 0: no detection 1: only at constant speed detection 2: Always testing Ten places: alarm selection 0: Free stop and report failure 1: alarm and continue to run	00 (00 ~12)

Set the warning detection mode selection and alarm mode selection when the motor reference speed and feedback speed deviation are too large, and use F10.41 [speed deviation excessive detection threshold] F10.42 [speed deviation excessive detection time] .

Unit: Check out the selection

0: Do not detect, turn off the speed deviation too large protection function

1: Only at constant speed detection, open speed deviation protection function only at constant speed operation

2: Always detect, open speed deviation protection function when adding, decelerating and constant speed control

Ten place: fault selection
 0: Free stop and output fault alarm E.DEF
 1: Continue to run and output fault warning A.DEF

Code (Addr.) Adjustable attribute	Name	Content	Factory setting (Setting range)
F10.41 (0x0A29) STOP	Speed deviation excessive detection threshold	V/F SVC Set the detected value whose speed deviation is too large. This value corresponds to F01.10 [maximum frequency].	10.0% (0 ~60.0%)
F10.42 (0x0A2A) STOP	Speed deviation too large detection time	V/F SVC Set the duration of excessive detection speed deviation, the deviation of the given speed and feedback speed is greater than F10.41 and continue for this time, and the detection speed deviation is too large.	2s (0 ~60)

Note: The speed deviation detection threshold is 100% corresponding to F01.10 [maximum frequency].
 When the deviation between the speed feedback value and the speed set value corresponds to the F01.10 [maximum frequency] percentage value is greater than F10.41 in the set time of F10.42 [speed deviation excessive detection time] [speed deviation over-detection When the threshold value is exceeded, the inverter considers that the detected deviation is too large, and performs the corresponding action according to the set value of F10.40 [Speed deviation excessive protection action].

Code (Addr.) Adjustable attribute	Name	Content	Factory setting (Setting range)
F10.43 (0x0A2B) STOP	Speed protection action	V/F SVC Set the alarm detection mode selection and alarm mode selection when the motor is flying fast Unit: Check out the selection 0: no detection 1: only at constant speed detection 2: Always testing Ten places: alarm selection 0: Free stop and report failure 1: alarm and continue to run	00 (00 ~12)

Set the alarm detection mode selection and alarm mode selection when the motor feedback speed is abnormally large, and use it with F10.44 [Flying detection threshold] F10.452 [Fast detection time].
 Unit: Check out the selection
 0: Do not detect, turn off the fast protection function
 1: Only at constant speed detection, only speed fast protection function is enabled at constant speed operation
 2: Always detect, start the fast protection function when adding, decelerating and constant speed control
 Ten place: fault selection
 0: Free stop and output fault alarm E.SPD
 1: Continue to run and output fault warning A.SPD

Code (Addr.) Adjustable attribute	Name	Content	Factory setting (Setting range)
F10.44 (0x0A2C) STOP	Rapid detection threshold	V/F SVC Set the detection value of the fast warning, which corresponds to F01.10 [maximum frequency]	110.0% (0 ~150.0%)
F10.45 (0x0A2D) STOP	Rapid detection time	V/F SVC Set the duration of the detection of the flying speed, the feedback speed is greater than F10.44 and continue for that time, and the speed warning is detected.	0.05s (0 ~2)

Note: The speed detection threshold is 100% corresponding to F01.10 [maximum frequency].
 When the speed feedback value corresponds to the percentage value of F01.10 [maximum frequency] in the set time of F10.45 [flying detection time] is greater than F10.44 [flying detection threshold], the inverter considers that the speed warning is detected, according to The set value of F10.43 [Fast protection action] is acted upon accordingly.

F10.5x group: Failure recovery protection

The fault self-recovery function automatically resets the temporary fault when the inverter detects a temporary fault but does not want the machine to stop running. When the number of self-recovery faults exceeds the set value within the set time, the inverter detects the fault and

stops. At this time, the fault is manually reset after the fault is eliminated.

DANGER! Do not use the fault self-recovery function in the event that the hoist does not recover automatically after lifting the load or after a malfunction. Failure to do so may result in personal injury.

Code (Addr.) Adjustable attribute	Name	Content	Factory setting (Setting range)
F10.50 (0x0A32) STOP	Failure self-recovery setting	V/F SVC Set the number of fault self-recovery allowed to be executed Note: A value of 0 means that the fault self-recovery function is turned off, otherwise it means that the function is enabled.	0 (0 ~10)

Note: When this parameter is set to 0, the fault self-recovery function is turned off.

Set the number of self-recovery faults that are allowed to be executed. Each time the fault is self-recovery, the number of fault recovery times is reduced by 1. When it is 0, the fault is detected and the fault self-recovery is no longer performed.

When the inverter is in the stop state, the number of fault self-resets will return to the set value of F10.50.

Note: During the self-recovery function is turned on, the fault occurs during the stop deceleration, and the fault self-recovery is not performed.

Code (Addr.) Adjustable attribute	Name	Content	Factory setting (Setting range)
F10.51 (0x0A33) STOP	Failure self-recovery interval	V/F SVC Set the waiting time after the inverter fails to each reset	1.0s (0 ~100.0)

Set the waiting time from the fault of the inverter to each reset. During this time, the keyboard displays the fault character at this time, but the running indicator is still lit.

Code (Addr.) Adjustable attribute	Name	Content	Factory setting (Setting range)
F10.52 (0x0A34) READ	Number of failures recovered	V/F SVC Indicates the number of self-recovery faults that have been performed. This parameter is a read-only parameter.	0

Indicates the number of self-recovery faults that have been performed. It is convenient for the user to confirm the usage status of the fault self-recovery function. This parameter is a read-only parameter.

11.13 F11 Group: keyboard parameters

F11.0x group: button operation

◇ ▯ F11.00: Key lock selection

Code (Addr.)	Name	Content	Factory setting (Setting range)
F11.00 (0x0B00) RUN	Parameter and key lock selection	V/F SVC	0 (0 ~ 3)

0: not locked

The parameter and key lock function are invalid.

1: function parameter lock

It is forbidden to modify the parameters of all function parameters. (In addition to the function code specified by the up and down keys, you can modify the value by the up and down keys). The keyboard cannot enter the modification parameter interface, and the monitoring amount can be selected by shifting the keyboard. All key functions on the keyboard are not locked.

2: Function parameters and key lock

Locks the setpoints of all function parameters. The keyboard cannot enter the modification parameter interface, and the keyboard monitoring amount cannot be selected. It is forbidden to modify the parameters. At the same time, all the keys except RUN/STOP/JOG/PRG on the keyboard are locked.

3: Function parameters and key lock

Locks the set values of all function parameters, prohibits modification of parameters; and locks all keys on the keyboard except PRG.

Note:

- Double-line digital tube keyboard unlocking method: Double-line digital tube keyboard displays "CodE" on the first line of the keyboard after pressing the "PRG" menu button. You can use the up and down keys to enter the user password (F11.01 - user password) in the second line and then press the "SET" button to unlock.
- Single-line digital tube keyboard unlocking method: Single-line digital tube keyboard displays "CodE" after pressing "PRG" menu button. Then press the "SET" button to display the flashing input cursor. Enter the user password (F11.01-user password) through the up and down keys and press the "SET" button again to confirm.

- The user password is a protective parameter set by the customer to protect the inverter parameters arbitrarily tampering. After the password is set, the password should be properly kept in case it is inconvenient to modify the parameters later.
- After unlocking, entering the monitoring interface will exit the unlocking. You need to enter the password again to enter the parameter interface.

◇ ¶ F11.00: Key lock password

Code (Addr.)	Name	Content	Factory setting (Setting range)
F11.01 (0x0B01) RUN	Key lock password	V/F SVC Used to set the key lock password	0 (0 ~ 65535)

◇ ¶ F11.02: Keyboard multi-function button selection

Code (Addr.)	Name	Content	Factory setting (Setting range)
F11.02 (0x0B02) STOP	Keyboard multi-function key selection	V/F SVC	1 (0 ~ 7)

- 0: invalid
 1: Reverse run key
 2: Forward jog operation key
 3: Reverse jog run key
 4: Keyboard command channel and terminal naming channel switch
 5: Keyboard command channel and communication naming channel switch
 6: Terminal command channel and communication naming channel switch
 7: keyboard, terminal, communication command channel cycle switching

◇ ¶ F11.03: Keyboard STOP button setting

Code (Addr.)	Name	Content	Factory setting (Setting range)
F11.03 (0x0B03) STOP	Keyboard STOP button settings	V/F SVC	0 (0 ~ 2)

0: Non-keyboard control mode is invalid. The keyboard stop button STOP cannot be stopped as a stop button when it is not a keyboard control operation signal.

1: Non-keyboard control mode is stopped according to stop mode. When the keyboard stop button STOP is used as the non-keyboard control running signal, it can be used as the stop button to stop the inverter in the stop mode set by [F07.10]. It can be used as the stop button, and the stop mode is [F07.10] setting mode.

2: Non-keyboard control mode is stopped in free mode. When the keyboard stop button STOP is used as the non-keyboard control running signal, it can be used as the stop button to stop the inverter in the free stop mode. Can be used as a stop button, the stop mode is free stop.

Note:

- If [F11.03] selects 1 or 2, the inverter will be in the stop lock state after the keyboard stop button is stopped during terminal control or RS485 control. In this case, if the inverter is to be re-run, the stop command must be sent to the selected run command channel to release the lock state before the inverter can run again.

◇ ¶ F11.04: Status interface up and down keys (knob) function selection

Code (Addr.)	Name	Content	Factory setting (Setting range)
F11.04 (0x0B04) STOP	Status interface up and down keys (knob) function selection	V/F SVC	0011 (0000~0213)

Single digit: keyboard up and down keys to modify the selection

- 0: invalid
 1: Used to adjust the frequency keyboard. The F01.09 keyboard up and down keys can quickly modify the setting value of the parameter [F01.09].
 2: Used to adjust the PID keyboard given F13.01 keyboard up and down keys can quickly modify the setting value of parameter [F13.01]
 3: Keyboard up and down keys to modify the parameter number setting Keyboard up and down keys can quickly modify the setting value of the parameter [Fxx.yy]

Ten place: power down storage

- 0: frequency is not stored when power is off
 1: frequency power down storage

Select whether to change the modified value to the corresponding parameter when the power is off after the parameter is quickly modified by the up and down keys of the keyboard.

Hundreds: Action Limit

- 0: adjustable operation stop
 1: Adjustable only during operation, stop and keep
 2: Adjustable during operation, stop and clear

Thousands: reserved

Note:

- ☐ Ten digits: Determine whether the changed data is stored in EEPROM

✧ ☐ F11.05: Up and down keys quickly change the parameter code setting

Code (Addr.)	Name	Content	Factory setting (Setting range)
F11.05 (0x0B05) RUN	Up and down keys to quickly change the parameter code setting	V/F SVC	0109 (0000~1559)

Keyboard up and down keys quickly modify the parameter number setting:

LED digits ten digits: function parameter number Fxx.yy yy setting 00~99

LED hundred thousand digits: function parameter number Fxx.yy xx setting 00~15

✧ ☐ F11.06: Keyboard command button selection

Code (Addr.)	Name	Content	Factory setting (Setting range)
F11.06 (0x0B06) STOP	Keyboard command key selection	V/F SVC	0000 (0000~1122)

LED ones: built-in, external keyboard button commands

(run command, stop/reset command)

0: External priority, when the external is valid, the built-in is invalid.

1: Built-in priority, when the built-in is valid, the external is invalid

2: Both internal and external are valid, the stop/reset command takes precedence; when both forward and reverse are active, the command is invalid.

LED ten: reserved

LED Hundreds: Reserved

LED Thousands: Keyboard Test (Communication Success Rate)

F11.1x group: Status interface cyclic monitoring

✧ ☐ F11.10: Status interface left shift, right shift key function selection

Code (Addr.)	Name	Content	Factory setting (Setting range)
F11.10 (0x0B0A) STOP	Status interface left shift, right shift key function selection	V/F SVC	0011 (0000~0011)

Unit digit: Left shift key to adjust the first line of monitoring 0: Invalid, 1: Valid

Ten digits: Right shift key to adjust the second line of monitoring 0: Invalid, 1: Valid

Note:

- The current loop parameter is displayed when invalid, and the loop parameter 1 is displayed after power-on.
- When the left/right shift key function selection is invalid, press the left/right shift key, the monitor will not switch; the left/right shift key function selection will be changed to valid, and the monitoring quantity will change immediately.

✧ F11.11: The first line of the keyboard shows the parameter 1

Code (Addr.)	Name	Content	Factory setting (Setting range)
F11.11 (0x0B0B) RUN	The first line of the keyboard shows the parameter 1	V/F SVC Used to set the contents of single-line keyboard and double-line keyboard display parameters	0000 (0000~0763)

✧ F11.12: The first line of the keyboard shows the parameter 2

Code (Addr.)	Name	Content	Factory setting (Setting range)
F11.12 (0x0B0C) RUN	The first line of the keyboard shows the parameter 2	V/F SVC Used to set the contents of single-line keyboard and double-line keyboard display parameters	0001 (0000~0763)

✧ ☐ F11.13 keyboard first line loop display parameter 3

Code (Addr.)	Name	Content	Factory setting (Setting range)
F11.13 (0x0B0D) RUN	The first line of the keyboard shows the parameter 3	V/F SVC Used to set the contents of single-line keyboard and double-line keyboard display parameters	0000 (0000~0763)

✧ ☐ F11.14: The first line of the keyboard shows the parameter 4

Code (Addr.)	Name	Content	Factory setting (Setting range)
F11.14 (0x0B0E) RUN	The first line of the keyboard shows the parameter 4	V/F SVC Used to set the contents of single-line keyboard and double-line keyboard display parameters	0000 (0000-0763)

✧ ¶ F11.15: The second line of the keyboard shows the parameter 1

Code (Addr.)	Name	Content	Factory setting (Setting range)
F11.15 (0x0B0F) RUN	The second line of the keyboard shows the parameter 1	V/F SVC Used to set the contents of the two-line keyboard display parameters	0002 (0000-0763)

✧ ¶ F11.16: The second line of the keyboard shows the parameter 2

Code (Addr.)	Name	Content	Factory setting (Setting range)
F11.16 (0x0B10) RUN	The second line of the keyboard shows the parameter 2	V/F SVC Used to set the contents of the two-line keyboard display parameters	0004 (0000-0763)

✧ ¶ F11.17: The second line of the keyboard shows the parameter 3

Code (Addr.)	Name	Content	Factory setting (Setting range)
F11.17 (0x0B11) RUN	The second line of the keyboard shows the parameter 3	V/F SVC Used to set the contents of the two-line keyboard display parameters	0010 (0000-0763)

✧ ¶ F11.18: The second line of the keyboard shows the parameter 4

Code (Addr.)	Name	Content	Factory setting (Setting range)
F11.18 (0x0B12) RUN	The second line of the keyboard shows the parameter 4	V/F SVC Used to set the contents of the two-line keyboard display parameters	0012 (0000-0763)

Keyboard display parameters: used to set the contents of the single-line keyboard and double-line keyboard display parameters.

Ten digits: Monitoring parameter number Cxx.yy, yy setting 00-63

Hundreds of thousands: monitoring parameter number Cxx.yy xx set 00-07

Note:

- The parameter [F11.15-F11.18] is only valid for the two-line keyboard. The two-line keyboard switches between the display parameters 1-4 of the second line of the keyboard by the "F" key.
- The single-line keyboard switches the keyboard display parameters 1-4 in sequence by long pressing the "SET" button (the two-line keyboard can be pressed through the "F" button). After the display content is switched, there is no power-off and memory function. After power-on, the content of "Display Parameter 1" is displayed by default.

F11.2x group: monitoring parameter control

✧ F11.20: Keyboard display item settings

Code (Addr.)	Name	Content	Factory setting (Setting range)
F11.20 (0x0B14) RUN	Keyboard display item settings	V/F SVC	0000 (0000-1112)

Unit digit: Output frequency display selection

0: Target frequency Displays the target frequency of the currently controlled motor

1: Running frequency Shows the output frequency after the inverter is operated.

2~F: target frequency filtering, the larger the value, the deeper the filtering

Ten: reserved

0: invalid

1: Active power to remove stator resistance loss

Hundreds: Power Display Dimensions

0: Power display percentage (%) Display output power is 100%, 100.0% bit motor rated power

1: Power display kilowatt (KW) display output power actual value

Thousands: reserved

◇ F11.21: Speed display factor

Code (Addr.)	Name	Content	Factory setting (Setting range)
F11.21 (0x0B15) RUN	Speed display factor	V/F SVC This parameter sets the display coefficient of the "mechanical speed" of the keyboard monitor item, and 100.0% corresponds to the rated motor speed.	100.0% (0.0 ~ 500.0%)

◇ F11.22: Power display factor

Code (Addr.)	Name	Content	Factory setting (Setting range)
F11.22 (0x0B16) RUN	Power display factor	V/F SVC This parameter sets the display coefficient ratio of the keyboard monitor "output power"	100.0% (0.0 ~ 500.0%)

Note:

- Correct C-10 output power value

◇ F11.23 monitoring parameter group display selection

Code (Addr.)	Name	Content	Factory setting (Setting range)
F11.23 (0x0B17) RUN	Monitoring parameter group display selection	V/F SVC Unit: Reserved Ten: C05 display selection 0, 1: VF mode related parameters 2: VC mode related parameters Hundreds place: C00.40~C00.63 display selection 0: invalid 1: valid Thousands: reserved	0000 (0000~FFFF)

◇ F11.24: Monitoring parameter filtering selection

Code (Addr.)	Name	Content	Factory setting (Setting range)
F11.24 (0x0B18) RUN	Monitoring parameter filtering selection	V/F SVC Unit: Output current display filter 0~F: the larger the value, the deeper the filter Ten: reserved Hundreds: reserved Thousands: reserved	0x0000 (0x0000 ~0x 000F)

◇ F11.25: Display selection when the motor is self-learning

Code (Addr.)	Name	Content	Factory setting (Setting range)
F11.25 (0x0B19) STOP	Display selection when the motor is self-learning	V/F SVC 0: Display the status of the self-learning process 1: Do not display the status of the self-learning process	0 (0 ~ 1)

◇ F11.27: Fault display selection

Code (Addr.)	Name	Content	Factory setting (Setting range)
F11.27 (0x0B1B) RUN	Fault display selection	V/F SVC Unit: The fault is displayed when the fault recovers. 0: not displayed 1: display	0x0001 (0x0000 ~ 0x0001)

F11.3x Group: Keyboard Special Features

Heed

Parameter [F11.30] sets RS485 / external keyboard to choose one. This parameter is not restored with [F00.03] parameter. Users are strongly advised to unlock the hardware connection of another channel when using one of them.

◇ ▯ F11.30: RD05 serial port function selection

Code (Addr.)	Name	Content	Factory setting (Setting range)
F11.30 (0x0B1E) STOP	RD05 serial port function selection	V/F SVC 0: RS485 1: external keyboard	0 (0~1)

✧ ¶ F11.31: keyboard potentiometer lower limit voltage

Code (Addr.)	Name	Content	Factory setting (Setting range)
F11.31 (0x0B1F) RUN	Keyboard potentiometer lower limit voltage	V/F SVC	0.50 (0 ~ 3.3v)

✧ ¶ F11.32: Keyboard potentiometer lower limit corresponding value

Code (Addr.)	Name	Content	Factory setting (Setting range)
F11.32 (0x0B20) RUN	Keyboard potentiometer lower limit corresponding value	V/F SVC	0.00% (0 ~ 100%)

✧ ¶ F11.33: Keyboard potentiometer upper limit voltage

Code (Addr.)	Name	Content	Factory setting (Setting range)
F11.33 (0x0B21) RUN	Keyboard potentiometer upper limit voltage	V/F SVC	2.80 (0 ~ 3.3v)

✧ ¶ F11.34: keyboard potentiometer upper limit corresponding value

Code (Addr.)	Name	Content	Factory setting (Setting range)
F11.34 (0x0B22) RUN	Keyboard potentiometer upper limit corresponding value	V/F SVC	0.00% (0 ~ 100%)

11.14 F12 Group: Communication parameters

The F12.00~F12.29 parameters are used for inverter settings when using MODBUS communication. Serial communication with the programmable controller (PLC) is possible using the built-in RS-485 port (terminals A+, B-) of the inverter and the MEMOBUS protocol.

Note

Parameter [F11.30] sets the MODBUS/external keyboard to choose one. This parameter is not restored with the [F00.03] parameter. Users are strongly advised to unlock the hardware connection of another channel when using one of them.

F12.0x group: MODBUS slave parameters

✧ ¶ F12.00: Master-slave selection

Code (Addr.)	Name	Content	Factory setting (Setting range)
F12.00 (0x0C00) STOP	Master-slave choice	V/F SVC Set the inverter Modbus communication host or slave	0 (0~1)

0: Slave When the inverter is used as a slave, the communication address is set by parameter [F12.01]. At this point, the inverter accepts commands from the host on the communication network. And according to the parameter [F12.04] setting, select whether to reply data when writing.

1: Host The inverter acts as the host and sends the host's data to the communication network through broadcast commands. All slaves receive host commands.

✧ ¶ F12.01: Modbus communication address

Code (Addr.)	Name	Content	Factory setting (Setting range)
F12.01 (0x0C01) STOP	Modbus communication address	V/F SVC Set the communication slave address of the inverter	1 (1~247)

Note: If 0 is set, the drive will not respond to MEMOBUS communication.
 When the host computer (master station) performs MEMOBUS communication with the inverter, set the slave address to the inverter. Please set a value other than F12.01=0.
 Do not conflict with the set slave address.

◇ ¶ F12.02: Communication baud rate selection

Code (Addr.)	Name	Content	Factory setting (Setting range)
F12.02 (0x0C02) STOP	Communication baud rate selection	V/F SVC Set the baud rate when Modbus communication	3 (0-6)

0:1200 bps
 1:2400 bps
 2:4800 bps
 3:9600 bps
 4:19200 bps
 5:38400 bps
 6:57600 bps

◇ ¶ F12.03: Modbus data format

Code (Addr.)	Name	Content	Factory setting (Setting range)
F12.03 (0x0C03) STOP	Modbus data format	V/F SVC Select the communication check used by MEMOBUS communication	0 (0-5)

Note: If the data format settings are different, communication may not be possible.

0: (N, 8, 1) no parity, data bits: 8, stop bits: 1
 1: (N, 8, 1) even parity, data bits: 8, stop bits: 1
 2: (N, 8, 1) odd parity, data bits: 8, stop bits: 1
 3: (N, 8, 1) no parity, data bits: 8, stop bits: 2
 4: (N, 8, 1) even parity, data bits: 8, stop bits: 2
 5: (N, 8, 1) odd parity, data bits: 8, stop bits: 2

◇ ¶ F12.04: Modbus transmission response processing

Code (Addr.)	Name	Content	Factory setting (Setting range)
F12.04 (0x0C04) RUN	Modbus transmission response processing	V/F SVC Select the communication check used by MEMOBUS communication	0 (0-1)

This parameter selects whether the inverter responds when the host computer issues a write operation command to the inverter. If the host computer needs the inverter to reply the information, the inverter will occupy the communication bus in a time-sharing manner. When doing communication control, the host computer needs to reserve enough time to reply the information to the inverter. If the host computer does not need the inverter to reply the information, only the command is sent to the inverter, and the write operation can be selected without response to improve the utilization efficiency of the communication bus. This parameter is valid only for write operations and has no effect on read operations.

0: The write operation has a response
 1: Write operation has no response

◇ ¶ F12.05: Modbus communication response delay

Code (Addr.)	Name	Content	Factory setting (Setting range)
F12.05 (0x0C05) RUN	Modbus communication response delay	V/F SVC Set Modbus master/slave communication response delay time	0ms (0-500ms)

This parameter defines the intermediate interval between the inverter and the Modbus communication slave station, and the response data is sent to the upper computer after the data reception is completed. If the response delay is less than the system processing time, the response delay is based on the system processing time. If the response delay is longer than the system processing time, the system waits until the response delay time expires before the system processes the data. Send data.

This parameter defines the frequency converter as the Modbus communication master station. The delay is the transmission interval of the host, and the internal limit is 2.5 characters.

◇ ¶ F12.06: Modbus communication timeout failure time

Code (Addr.)	Name	Content	Factory setting (Setting range)
F12.06 (0x0C06) RUN	Modbus communication timeout failure time	V/F SVC Set Modbus communication timeout failure time	1.0s (0.1-100.0s)

If the interval between one communication and the next communication exceeds the communication timeout period, it is considered that the communication has a disconnection fault, and [F12.07] determines the fault disconnection operation mode.

▮ F12.07: Communication disconnection processing

Code (Addr.)	Name	Content	Factory setting (Setting range)
F12.07 (0x0C07) RUN	Communication disconnection processing	V/F SVC Select the motor stop method when E.CE [MEMOBUS communication fault] is detected.	0 (0~3)

- 0: Do not detect timeout failure
- 1: alarm and free parking
- 2: Warning and continue to run
- 3: Forced shutdown

Note:

- The forced stop command is set, the motor is forcibly stopped according to the deceleration mode, and the running command is no longer responded to before the stop.

◇ F12.08: Receive data (address 0x3000) zero offset

Code (Addr.)	Name	Content	Factory setting (Setting range)
F12.08 (0x0C08) RUN	Receive data (address 0x3000) zero bias	V/F SVC Set 0x3000 communication address zero offset value, press zero when the final bias result is negative	0 (-100.00~100.00)

◇ F12.09: Receive data (address 0x3000) gain

Code (Addr.)	Name	Content	Factory setting (Setting range)
F12.09 (0x0C09) RUN	Receive data (address 0x3000) gain	V/F SVC Set 0x3000 communication address gain	100% (0.0~500.0%)

F12.1x group: MODBUS host parameters

◇ F12.10: Host cyclically send parameter selection

Code (Addr.)	Name	Content	Factory setting (Setting range)
F12.10 (0x0C0A) RUN	Host cyclically send parameter selection	V/F SVC Set the host to send parameters cyclically	0x0031 (0000~CCCC)

Unit, ten, one hundred, one thousand

- 0: invalid
- 1: Host running command
- 2: host given frequency
- 3: host output frequency
- 4: Host upper limit frequency
- 5: the given torque of the host
- 6: host output torque
- 7: Reserved
- 8: Reserved
- 9: Host PID given
- A: Host PID feedback
- B: Reserved
- C: active current component

◇ ▮ F12.11: Frequency given custom address setting

Code (Addr.)	Name	Content	Factory setting (Setting range)
F12.11 (0x0C0B) RUN	Frequency given custom address setting	V/F SVC Used to set the frequency given custom address	0x0000 (0000~FFFF)

Note:

- The default is 0: it means invalid, other values indicate that the address has priority over the function code parameter address.

◇ F12.12: Command given custom address setting

Code (Addr.)	Name	Content	Factory setting (Setting range)
--------------	------	---------	---------------------------------

F12.12 (0x0C0C) RUN	Command given custom address settings	V/F SVC Used to set the command given custom address	0x0000 (0000~FFFF)
---------------------------	---------------------------------------	---	-----------------------

Note:

- □ The default is 0: it means invalid, other values indicate that the address has priority over the function code parameter address.

◇ □ F12.13: Command given as forward run command value

Code (Addr.)	Name	Content	Factory setting (Setting range)
F12.13 (0x0C0D) RUN	Command given as forward run command value	V/F SVC Used to set the forward run command custom value	0x0001 (0000~FFFF)

◇ □ F12.14: Command given as reverse run command value

Code (Addr.)	Name	Content	Factory setting (Setting range)
F12.14 (0x0C0E) RUN	Command given as reverse run command value	V/F SVC Used to set the reverse run command custom value	0x0002 (0000~FFFF)

◇ □ F12.15: Command given as stop command value

Code (Addr.)	Name	Content	Factory setting (Setting range)
F12.15 (0x0C0F) RUN	Command given as stop command value	V/F SVC Used to set the stop run command custom value	0x0005 (0000~FFFF)

◇ □ F12.16: Command given as reset command value

Code (Addr.)	Name	Content	Factory setting (Setting range)
F12.16 (0x0C10) RUN	Command given as reset command value	V/F SVC Used to set the fault reset command custom value	0x0007 (0000~FFFF)

11.15 F13 Group: Process PID Control

F13.00-F13.06: PID given and feedback

◇ F13.00-F13.06: PID given and feedback

Code (Addr.)	Name	Content	Factory setting (Setting range)
F13.00 (0x0D00) RUN	PID controller given signal source	V/F SVC Used to set the PID signal to a given source	0 (0~9)

Set the input channel of the PID controller given signal.

0: Keyboard digital PID reference The PID reference value is determined by the setting value of [F13.01].

1: reserved

2: Voltage/current analog AI reference The PID reference is given by the voltage/current analog AI1.

3: Reserved

4: Reserved

5: Terminal pulse PUL reference PID reference is given by terminal pulse PUL.

6: RS485 communication reference PID reference value is given by RS485 communication.

7: Reserved

8: Terminal selection The PID reference value is selected by the combination of multi-function input terminals. The multi-function input terminal is set by [F05.00~F05.09].

9: Communication gives a working current.

Terminal switching selection diagram:

Terminal 3	Terminal 2	Terminal 1	PID given switching terminal selection
OFF	OFF	OFF	Keyboard digital PID given
OFF	OFF	ON	Reserved
OFF	ON	OFF	Voltage / current analog AI1 given
OFF	ON	ON	Voltage/current analog quantity AI2 given
ON	OFF	OFF	Reserved
ON	OFF	ON	Terminal pulse PUL given
ON	ON	OFF	RS485 communication given
ON	ON	ON	Option card

Note:

- Active current component: can be sent through the Flextronics CAN host, RS485 communication address is 0x3011.

◇ ¶ F13.01: Keyboard Digital PID Reference/Feedback

Code (Addr.)	Name	Content	Factory setting (Setting range)
F13.01 (0x0D01) RUN	Keyboard digital PID given / feedback	V/F SVC Used to set the keyboard digital PID reference/feedback value	50.0% (0.0~100.0%)

This parameter is valid only when [F13.00]/[F13.03] is set to keyboard digital PID reference/feedback; after this parameter is changed, the PID reference value in the monitoring object is automatically modified synchronously.
If the parameter [F11.04] LED is set to "2", the value of this parameter can be quickly modified by the keyboard up and down keys. After the parameter is quickly modified, the inverter saves the modified value when the power is off by [F11.04]. The setting value of the LED ten digits is determined.

◇ ¶ F13.02: PID given change time

Code (Addr.)	Name	Content	Factory setting (Setting range)
F13.02 (0x0D02) RUN	PID given change time	V/F SVC Used to set the PID given change time	1.00s (0.00~60.00s)

PID given change time:

Refers to the time required for the PID setting percentage to change from 0.0% to 100.0%; when the PID given changes, the PID reference value changes linearly according to the given change time, which reduces the adverse effect on the system caused by the given mutation.

◇ ¶ F13.03: PID controller feedback signal source

Code (Addr.)	Name	Content	Factory setting (Setting range)
F13.03 (0x0D03) RUN	PID controller feedback signal source	V/F SVC Used to set the PID controller feedback signal source	2 (0~9)

Set the input channel of the PID controller feedback signal.

0: keyboard digital PID to feedback

The PID feedback channel is determined by the set value of [F13.01].

1: reserved

2: Voltage/current analog AI feedback

The PID feedback channel is the voltage/current analog AI1.

3: Reserved

4: Reserved

5: terminal pulse PUL feedback

The PID feedback channel is the terminal pulse PUL.

6: RS485 communication feedback

The PID feedback channel is RS485 communication.

7: Reserved

8: Terminal selection

The PID feedback channel is selected by a combination of multi-function input terminals, and the multi-function input terminal is set by [F05.00~F05.09].

9: Local active current

Terminal switching selection diagram:

Terminal 3	Terminal 2	Terminal 1	PID given switching terminal selection
OFF	OFF	OFF	Keyboard digital PID feedback
OFF	OFF	ON	Reserved
OFF	ON	OFF	Voltage/current analog AI1 feedback
OFF	ON	ON	Voltage/current analog AI2 feedback
ON	OFF	OFF	Reserved
ON	OFF	ON	Terminal pulse PUL feedback
ON	ON	OFF	RS485 communication feedback
ON	ON	ON	Option card

Note:

- The PID controller given signal source and the PID controller feedback signal source cannot be set to the same channel; otherwise the PID will not work normally.

◇ ¶ F13.04: Feedback signal low pass filtering time

Code (Addr.)	Name	Content	Factory setting (Setting range)
--------------	------	---------	---------------------------------

F13.04 (0x0D04) RUN	Feedback signal low pass filtering time	V/F SVC Used to set the feedback signal low pass filter time	0.010 (0.000~6.000)
---------------------------	---	---	------------------------

Feedback signal filtering time: used to filter the feedback signal, which can reduce the influence of the feedback amount. The longer the filtering time, the stronger the anti-interference ability, but the reaction speed becomes slower.

◇ ▯ F13.05: Feedback signal gain

Code (Addr.)	Name	Content	Factory setting (Setting range)
F13.05 (0x0D05) RUN	Feedback signal gain	V/F SVC Used to set the feedback signal gain	1.00 (0.00~10.00)

Feedback signal gain: for linear proportional adjustment of the feedback input signal

◇ F13.06: Feedback signal range

Code (Addr.)	Name	Content	Factory setting (Setting range)
F13.06 (0x0D06) RUN	Feedback signal range	V/F SVC Used to set the feedback signal range	100.0 (0.0~100.0)

Feedback signal range: The PID feedback signal range is a dimensionless unit used to adjust the PID feedback display.

F13.07-13.24: PID adjustment

◇ ▯ F13.07: PID control selection

Code (Addr.)	Name	Content	Factory setting (Setting range)
F13.07 (0x0D07) RUN	PID control selection	V/F SVC	0100 (0000~1111)

Unit position: feedback feature selection

0: Positive characteristic Applicable when the PID feedback amount is greater than the PID given amount, it is required to reduce the inverter output frequency to maintain the PID balance; such as constant pressure water supply, gas supply, winding tension control, etc.

1: Negative characteristic Applicable when the PID feedback amount is greater than the PID given amount, the inverter output frequency is required to rise to maintain the PID balance; such as the central air conditioning thermostat control, unwinding tension control.

Ten: reserved

Hundreds: reserved

Thousands: differential adjustment properties

0: Differentiate the deviation

1: Differentiate the feedback

◇ ▯ F13.08: PID preset output

Code (Addr.)	Name	Content	Factory setting (Setting range)
F13.08 (0x0D08) RUN	PID preset output	V/F SVC Used to set the PID preset output	100.0% (0.0~100.0%)

◇ ▯ F13.09: PID preset output running time

Code (Addr.)	Name	Content	Factory setting (Setting range)
F13.09 (0x0D09) RUN	PID preset output running time	V/F SVC Used to set the PID preset output running time	0.0s (0.0~6500.0s)

This function is defined as the PID running after the start, the output is first preset according to the PID preset output [F13.08], and the time set by the PID preset output running time [F13.09] is continuously run on the output value. PID closed loop characteristic operation.

Hint: When PID is used for frequency reference [F01.02=8] preset output 100% corresponds to maximum frequency output.

◇ ▯ F13.10: PID control deviation limit

Code (Addr.)	Name	Content	Factory setting (Setting range)
F13.10 (0x0D0A) RUN	PID control deviation limit	V/F SVC Used to set the PID control deviation limit	0.0% (0.0~100.0%)

The PID feedback amount is the maximum deviation allowed for the PID given; when the feedback amount is within this range, the PID adjustment stops and the output remains unchanged; the reasonable use of this function helps to coordinate the accuracy and stability of the system output. contradiction.

✧ ¶ F13.11: Proportional gain P1

Code (Addr.)	Name	Content	Factory setting (Setting range)
F13.11 (0x0D0B) RUN	Proportional gain P1	V/F SVC Determine the adjustment strength of the entire PID regulator, the greater the gain, the greater the adjustment intensity, but how easy it is to oscillate	0.100 (0.000~4.000)

✧ ¶ F13.12: Integration time I1

Code (Addr.)	Name	Content	Factory setting (Setting range)
F13.12 (0x0D0C) RUN	Integration time I1	V/F SVC Determine the intensity of the PID regulator integral adjustment, the shorter the integration time, the more the adjustment strength; when set to 0, the PID integral effect is invalid.	1.0s (0.0~600.0s)

✧ ¶ F13.13: Differential gain D1

Code (Addr.)	Name	Content	Factory setting (Setting range)
F13.13 (0x0D0D) RUN	Differential gain D1	V/F SVC Determine the intensity of the PID regulator's adjustment to the deviation or feedback signal rate of change, select the differential adjustment property by [F13.07] thousand bits; the longer the differentiation time, the greater the adjustment strength	0.000 (0.000~6.000)

✧ ¶ F13.14: Proportional gain P2

Code (Addr.)	Name	Content	Factory setting (Setting range)
F13.14 (0x0D0E) RUN	Proportional gain P2	V/F SVC Determine the intensity of the PID regulator integral adjustment, the shorter the integration time, the more the adjustment strength; when set to 0, the PID integral effect is invalid.	0.100 (0.000~4.000)

✧ ¶ F13.15: Integration time I2

Code (Addr.)	Name	Content	Factory setting (Setting range)
F13.15 (0x0D0F) RUN	Integration time I2	V/F SVC Set the integration time. When set to 0, the PID integral effect is invalid.	1.0s (0.0~600.0s)

✧ ¶ F13.16: Differential gain D2

Code (Addr.)	Name	Content	Factory setting (Setting range)
F13.16 (0x0D10) RUN	Differential gain D2	V/F SVC Determine the intensity of the PID regulator's adjustment to the deviation or feedback signal rate of change, select the differential adjustment property by [F13.07] thousand bits; the longer the differentiation time, the greater the adjustment strength	0.000 (0.000~6.000)

The adjustment parameters of the PID controller should be adjusted according to the actual system characteristics. PID parameter group 1 (F13.11~F13.13) and PID parameter group 2 (F13.14~F13.16) are used for the condition selection of two sets of PID parameter switching by [F13.17] function code.

Proportional gain:

Determine the adjustment strength of the entire PID regulator. The greater the gain, the greater the adjustment intensity, but how easy it is to generate oscillation.

Integration time:

Determine the intensity of the PID regulator integral adjustment. The shorter the integration time, the greater the adjustment intensity; the integration time is 0, and the PID adjustment function is invalid.

Differential gain:

Determine the intensity of the PID regulator's adjustment to the deviation or feedback signal rate of change, select the differential adjustment property by [F13.07] thousand bits; the longer the differentiation time, the greater the adjustment intensity. The function of the differential adjustment is to adjust the change according to the trend when the feedback signal changes, thereby suppressing the change of the feedback signal.

✧ ¶ F13.17: PID parameter switching conditions

Code (Addr.)	Name	Content	Factory setting (Setting range)
--------------	------	---------	---------------------------------

F13.17 (0x0D11) RUN	PID parameter switching condition	V/F SVC Used to set PID parameter switching conditions	0 (0~2)
---------------------------	--------------------------------------	---	------------

In some applications, a set of PID adjustment parameters cannot meet the requirements of the entire process, and different PID parameter sets are required.

PID parameter switching conditions:

0: Do not switch PID parameter to select PID parameter group 1.

1: Use D1 terminal to switch Multi-function terminal function selection to set 23 (PID parameter switching), select PID parameter group 1 when the terminal is invalid, and select PID parameter group 2 when the terminal is valid.

2: Switch according to deviation When the absolute value of deviation between PID reference and feedback is less than [F13.18], PID parameter selects parameter group 1; when the absolute value of deviation between PID given and feedback is greater than [F13.19] When the PID parameter selects parameter group 2; when the absolute value of the deviation between the PID reference and the feedback is between the switching deviation low value [F13.18] and the switching deviation high value [F13.19], the PID parameter is two The linear interpolation value of the group PID parameters is shown in the figure below.

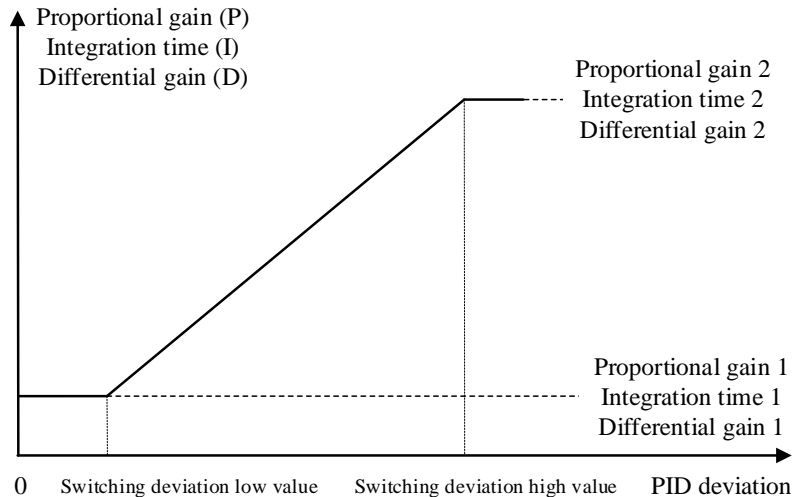

Switching the PID parameters according to the deviation

◇ F13.18: Switching deviation low value

Code (Addr.)	Name	Content	Factory setting (Setting range)
F13.18 (0x0D12) RUN	Switching deviation low value	V/F SVC	20.0% (0.0~100.0%)

◇ F13.19: Switching deviation high value

Code (Addr.)	Name	Content	Factory setting (Setting range)
F13.19 (0x0D13) RUN	Switching deviation high value	V/F SVC	80.0% (0.0~100.0%)

◇ F13.21: Differential Limiting

Code (Addr.)	Name	Content	Factory setting (Setting range)
F13.21 (0x0D15) RUN	Differential limiting	V/F SVC	5.0% (0.0~100.0%)

Differential limiting is used to set the range of the PID differential output. In the PID regulator, the effect of the differential is sensitive, and it is easy to cause the system to oscillate. Generally, the effect of PID differentiation is limited to a small range.

◇ F13.22: PID output upper limit

Code (Addr.)	Name	Content	Factory setting (Setting range)
F13.22 (0x0D16) RUN	PID output upper limit	V/F SVC Used to set the PID output upper limit value	100.0% (0.0~100.0%)

◇ F13.23: PID output lower limit

Code (Addr.)	Name	Content	Factory setting (Setting range)
F13.23 (0x0D17) RUN	PID output lower limit	V/F SVC Used to set the PID output lower limit value	0.0% (-100.0~Fb.19)

◇ ▮ F13.24: PID output filter time

Code (Addr.)	Name	Content	Factory setting (Setting range)
F13.24 (0x0D18) RUN	PID output filtering time	V/F SVC Used to set the PID output filter time	0.000s (0.000~6.000s)

The PID output filter time is used to filter the PID output, which will attenuate the sudden change of the PID regulation output and bring about a decrease in the response performance of the process closed-loop system.

F13.25-F13.28: PID feedback disconnection judgment

The feedback disconnection detection function is defined as when the inverter reference mode is selected as PID timing, and when the inverter is running, when the detected feedback signal is greater than the set value of [F13.27] or less than [F13.28] The sensor is disconnected after setting the value and maintaining the delay time of [F13.26].

◇ ▮ F13.25: Feedback disconnection action selection

Code (Addr.)	Name	Content	Factory setting (Setting range)
F13.25 (0x0D19) STOP	Feedback disconnection action selection	V/F SVC	0 (0~3)

Feedback disconnection action selection:

0: Continue PID operation without reporting fault This function is invalid, the inverter does not detect disconnection.

1: Stop and output fault alarm E.PID When the inverter detects that the sensor is disconnected, it immediately blocks the output, and the motor is free to stop and alarm E.PID.

2: Continue PID operation, output fault warning A.PID When the inverter detects that the sensor is disconnected, it still presses PID to adjust the operation, but the keyboard displays the warning A.PID.

3: Run at the current frequency, output fault warning A.PID When the inverter detects that the sensor is disconnected, the output frequency before the fault remains unchanged, but the keyboard displays the warning A.PID.

◇ ▮ F13.26: Feedback disconnection detection time

Code (Addr.)	Name	Content	Factory setting (Setting range)
F13.26 (0x0D1A) RUN	Feedback disconnection detection time	V/F SVC Used to set the PID feedback disconnection detection time	1.0s (0.0~120.0s)

◇ ▮ F13.27: Upper limit of disconnection alarm

Code (Addr.)	Name	Content	Factory setting (Setting range)
F13.27 (0x0D1B) RUN	Wire break alarm upper limit	V/F SVC Used to set the PID disconnection alarm upper limit value	100.0% (0.0~100.0%)

◇ ▮ F13.28: Lower limit of disconnection alarm

Code (Addr.)	Name	Content	Factory setting (Setting range)
F13.28 (0x0D1C) RUN	Wire break alarm lower limit	V/F SVC Used to set the PID disconnection alarm lower limit value	0.0% (0.0~100.0%)

Broken line alarm upper limit:

Set the upper limit of the PID sensor disconnection detection. When the feedback signal exceeds the upper limit of the disconnection alarm and continues the delay time of [F13.26], the sensor is considered to be disconnected.

Broken line alarm upper limit:

Set the lower limit of the PID sensor disconnection detection. If the feedback signal is less than the lower limit of the disconnection alarm and continues the delay time of [F13.26], the sensor is considered to be disconnected.

F13.29-F13.33: Sleep function

The PID sleep function can be used in the constant pressure water supply industry to achieve energy saving goals.

Sleep into the judgment:

When the sleep function is valid, when the PID adjustment output frequency is lower than the set [F13.30] sleep frequency, it will enter the sleep state after the [F13.31] sleep delay (ie, the output will be blocked after deceleration to zero frequency).

Note: Sleep enters the precondition. When the PID feedback is greater than the PID given when the positive characteristic is triggered, the PID feedback is triggered only when the PID feedback is less than the PID given.

Sleep wakeup judgment:

When the PID feedback characteristic is positive characteristic: the value of PID given minus the wake-up deviation [F13.32] is compared with the PID feedback. If it continues to be greater than the wake-up delay [F13.33], it will exit the sleep state and enter the normal running state.

When the PID feedback characteristic is inverse characteristic: the value of PID given plus wake-up deviation [F13.32] is compared with the PID feedback. If it continues to be greater than the wake-up delay [F13.33], it will exit the sleep state and enter the normal running state.

✧ ¶ F13.29: Sleep selection

Code (Addr.)	Name	Content	Factory setting (Setting range)
F13.29 (0x0D1D) RUN	Sleep choice	V/F SVC 0: Invalid, no sleep detection 1: effective for sleep detection	0 (0~1)

✧ ¶ F13.30: Sleep frequency

Code (Addr.)	Name	Content	Factory setting (Setting range)
F13.30 (0x0D1E) RUN	Sleep frequency	V/F SVC Used to set the PID sleep frequency	10.0Hz (0.00~50.00Hz)

✧ ¶ F13.31: sleep delay

Code (Addr.)	Name	Content	Factory setting (Setting range)
F13.31 (0x0D1F) RUN	Sleep delay	V/F SVC Used to set the PID sleep delay	60.0s (0.0~3600.0s)

✧ ¶ F13.32: wake-up deviation

Code (Addr.)	Name	Content	Factory setting (Setting range)
F13.32 (0x0D20) RUN	Wake up deviation	V/F SVC Used to set the PID wake-up deviation	5.0% (0.0~50.0%)

✧ ¶ F13.33: wake-up delay

Code (Addr.)	Name	Content	Factory setting (Setting range)
F13.33 (0x0D21) RUN	Wake-up delay	V/F SVC Used to set the PID wake-up delay	1.0s (0.0~60.0s)

11.16 F14 Group: multi-speed and simple PLC

F14.00-F14.14: Multi-speed frequency given

This group of parameters is used to set the operating frequency of the fifteen-segment speed in the PLC program operation and multi-step speed control.

Multi-segment speed control has priority next to jog control. When the user selects multi-speed operation, it is necessary to set 4 multi-function input terminals as multi-speed control terminals. For details on how to set it, refer to [F05.00~F05.09] for details.

✧ ¶ F14.00: PLC multi-speed 1

Code (Addr.)	Name	Content	Factory setting (Setting range)
F14.00 (0x0E00) RUN	PLC multi-speed 1	V/F SVC Set the first run frequency of the PLC program operation and multi-step speed control	10.00Hz (0.00 ~ Maximum frequency)

✧ ¶ F14.01: PLC multi-speed 2

Code (Addr.)	Name	Content	Factory setting (Setting range)
F14.01 (0x0E01) RUN	PLC multi-speed 2	V/F SVC Set the second stage running frequency in PLC program operation and multi-step speed control	20.00Hz (0.00 ~ Maximum frequency)

✧ ¶ F14.02: PLC multi-speed 3

Code (Addr.)	Name	Content	Factory setting (Setting range)
F14.02 (0x0E02) RUN	PLC multi-speed 3	V/F SVC Set the third stage running frequency in PLC program operation and multi-step speed control	30.00Hz (0.00 ~ Maximum frequency)

✧ ¶ F14.02: PLC multi-speed 4

Code (Addr.)	Name	Content	Factory setting (Setting range)
F14.03 (0x0E03) RUN	PLC multi-speed 4	V/F SVC Set the 4th stage running frequency in PLC program operation and multi-step speed control	40.00Hz (0.00 ~ Maximum frequency)

✧ ¶ F14.02: PLC multi-speed 5

Code (Addr.)	Name	Content	Factory setting (Setting range)
F14.04 (0x0E04) RUN	PLC multi-speed 5	V/F SVC Set the 5th stage running frequency in PLC program operation and multi-step speed control	50.00Hz (0.00 ~ Maximum frequency)

✧ ¶ F14.02: PLC multi-speed 6

Code (Addr.)	Name	Content	Factory setting (Setting range)
F14.05 (0x0E05) RUN	PLC multi-speed 6	V/F SVC Set the 6th stage running frequency in PLC program operation and multi-step speed control	40.00Hz (0.00 ~ Maximum frequency)

✧ ¶ F14.02: PLC multi-speed 7

Code (Addr.)	Name	Content	Factory setting (Setting range)
F14.06 (0x0E06) RUN	PLC multi-speed 7	V/F SVC Set the 7th stage running frequency in PLC program operation and multi-step speed control	30.00Hz (0.00 ~ Maximum frequency)

✧ ¶ F14.02: PLC multi-speed 8

Code (Addr.)	Name	Content	Factory setting (Setting range)
F14.07 (0x0E07) RUN	PLC multi-speed 8	V/F SVC Set the 8th stage running frequency in PLC program operation and multi-step speed control	20.00Hz (0.00 ~ Maximum frequency)

✧ ¶ F14.02: PLC multi-speed 9

Code (Addr.)	Name	Content	Factory setting (Setting range)
F14.08 (0x0E08) RUN	PLC multi-speed 9	V/F SVC Set the 9th stage running frequency in PLC program operation and multi-step speed control	10.00Hz (0.00 ~ Maximum frequency)

✧ ¶ F14.02: PLC multi-speed 10

Code (Addr.)	Name	Content	Factory setting (Setting range)
F14.09 (0x0E09) RUN	PLC multi-speed 10	V/F SVC Set the 10th stage running frequency in PLC program operation and multi-step speed control	20.00Hz (0.00 ~ Maximum frequency)

✧ ¶ F14.02: PLC multi-speed 11

Code (Addr.)	Name	Content	Factory setting (Setting range)
F14.10 (0x0E0A) RUN	PLC multi-speed 11	V/F SVC Set the 11 th stage running frequency in PLC program operation and multi-step speed control	30.00Hz (0.00 ~ Maximum frequency)

✧ ¶ F14.02: PLC multi-speed 12

Code (Addr.)	Name	Content	Factory setting (Setting range)
F14.11 (0x0E0B) RUN	PLC multi-speed 12	V/F SVC Set the 12th stage running frequency in PLC program operation and multi-step speed control	40.00Hz (0.00 ~ Maximum frequency)

◇ ▯ F14.02: PLC multi-speed 13

Code (Addr.)	Name	Content	Factory setting (Setting range)
F14.12 (0x0E0C) RUN	PLC multi-speed 13	V/F SVC Set the 13th stage running frequency in PLC program operation and multi-step speed control	50.00Hz (0.00 ~ Maximum frequency)

◇ ▯ F14.02: PLC multi-speed 14

Code (Addr.)	Name	Content	Factory setting (Setting range)
F14.13 (0x0E0D) RUN	PLC multi-speed 14	V/F SVC Set the 14th stage running frequency in PLC program operation and multi-step speed control	40.00Hz (0.00 ~ Maximum frequency)

◇ ▯ F14.02: PLC multi-speed 15

Code (Addr.)	Name	Content	Factory setting (Setting range)
F14.14 (0x0E0E) RUN	PLC multi-speed 15	V/F SVC Set the 15th stage running frequency in PLC program operation and multi-step speed control	30.00Hz (0.00 ~ Maximum frequency)

The speed of the inverter running is controlled by the combination of the four multi-speed control terminals and COM ON/OFF. Its operation and direction are controlled by the motion signal and direction given by the command channel [F01.01]. The acceleration and deceleration time defaults to acceleration and deceleration time 1[F01.22], [F01.23], and can also be set by the acceleration/deceleration time selection terminal set by the multi-function input terminal [F05.00~F05.09]. Select the acceleration and deceleration time.

Multi-speed terminal 4	Multi-speed terminal 3	Multi-speed terminal 2	Multi-speed terminal 1	Terminal
				Multi-speed
OFF	OFF	OFF	ON	1X [F12.00]
OFF	OFF	ON	OFF	2X [F12.01]
OFF	OFF	ON	ON	3X [F12.02]
OFF	ON	OFF	OFF	4X [F12.03]
OFF	ON	OFF	ON	5X [F12.04]
OFF	ON	ON	OFF	6X [F12.05]
OFF	ON	ON	ON	7X [F12.06]
ON	OFF	OFF	OFF	8X [F12.07]
ON	OFF	OFF	ON	9X [F12.08]
ON	OFF	ON	OFF	10X [F12.09]
ON	OFF	ON	ON	11X [F12.10]
ON	ON	OFF	OFF	12X [F12.11]
ON	ON	OFF	ON	13X [F12.12]
ON	ON	ON	OFF	14X [F12.13]
ON	ON	ON	ON	15X [F12.14]

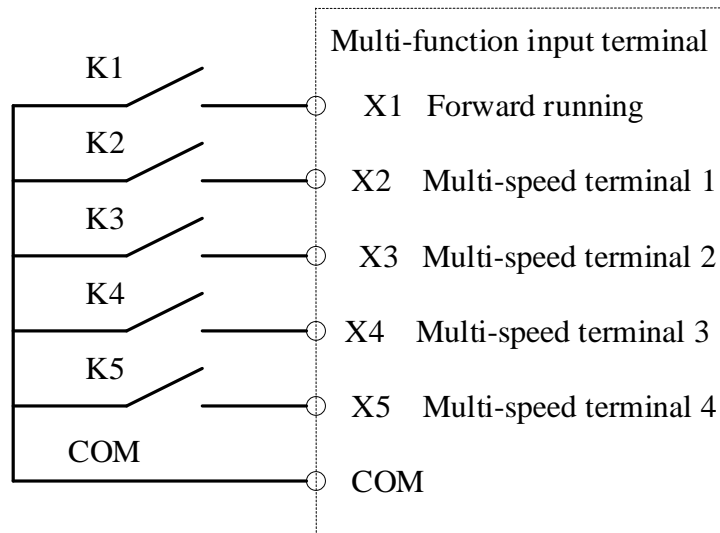

Terminal connection diagram

F14.15: PLC operation mode selection

◇ ▮ F14.15: PLC operation mode selection

Code (Addr.)	Name	Content	Factory setting (Setting range)
F14.15 (0x0E0F) RUN	PLC operation mode selection	V/F SVC	0000 (0000~2122)

LED ones: Cycle mode Used to select the PLC mode of operation for program control.

0: After stopping the operation command after single cycle, the inverter starts running from the first speed. The time unit is set by the LED tens of [F14.15]; the running time is set by the parameter [F14.16~F14.30]. The running direction and acceleration/deceleration time are selected by the parameter [F14.31~F14.45]; when the running time is reached, the next step speed is run, and the time, direction and acceleration/deceleration time of each speed running can be set separately; After the 15th speed is completed, the inverter outputs "0" frequency. If the run time of a phase is zero, then run it and skip it.

1: Continuous cycle After the inverter runs the 15th speed, it will return to the first speed and restart the operation, and the cycle will not stop. The time unit is set by the LED tens of [F14.15]; the running time is set by the parameter [F14.16~F14.30]; the running direction and acceleration/deceleration time are selected by the parameter [F14.31~F14.45].

2: Maintain the final value after single cycle After the inverter runs through a single cycle, it will not stop, and will continue to run at the phase speed where the last one running time is not zero. The time unit is set by the LED tens of [F14.15]; the running time is set by the parameter [F14.16~F14.30]; the running direction and acceleration/deceleration time are selected by the parameter [F14.31~F14.45].

LED tens: Time unit Used to set the time unit for timing when the program is running.

0: second

1 point

2 hours

LED Hundreds: Power-down storage

0: no storage

1: storage

This parameter is defined as whether the program runs the current state (running phase, reputation time, acceleration and deceleration, and running direction, etc.) after the inverter is powered off when the program is selected for operation. If you select power-down storage, the LED thousands parameter of [F14.15] can be used to define the recovery mode of the program after the next power-on. If the inverter can continue the state before the power failure after the instantaneous power failure recovery, the parameter should be set to "1".

LED Thousands: Startup mode

0: Re-run from the first stage

1: Start from the stage of the stop time

2: continue to run for the rest of the downtime phase

This parameter defines the mode of operation when the program is restarted after various reasons (stop, fault, power failure, etc.) during the running of the program.

Select "0" mode and the inverter will restart at the first speed.

When the "1" mode is selected, the inverter will restart the operation in the running phase of the interruption.

When the "2" mode is selected, the inverter will run in the running phase of the interruption moment and the remaining time of the interruption moment.

Note:

- The output frequency of the program is limited by the upper and lower limits. When the given frequency is lower than the lower limit frequency, press [F01.13] lower limit frequency operation mode.

F14.16-F14.30: PLC running time selection

Set the running time of the 15-segment speed separately. The time unit is determined by the setting value of the LED tens of [F14.15].

✧ ¶ F14.16: PLC first stage running time

Code (Addr.)	Name	Content	Factory setting (Setting range)
F14.16 (0x0E10) RUN	PLC first stage running time	V/F SVC Set the first run time of the PLC program running	10.0s 0.0~6500.0(s/m/h)

✧ ¶ F14.17: PLC second stage running time

Code (Addr.)	Name	Content	Factory setting (Setting range)
F14.17 (0x0E11) RUN	PLC 2 nd stage running time	V/F SVC Set the 2 nd run time of the PLC program running	10.0s 0.0~6500.0(s/m/h)

✧ ¶ F14.18: PLC third stage running time

Code (Addr.)	Name	Content	Factory setting (Setting range)
F14.18 (0x0E12) RUN	PLC 3 rd stage running time	V/F SVC Set the 3 rd run time of the PLC program running	10.0s 0.0~6500.0(s/m/h)

✧ ¶ F14.19: PLC 4th running time

Code (Addr.)	Name	Content	Factory setting (Setting range)
F14.19 (0x0E13) RUN	PLC 4 th stage running time	V/F SVC Set the 4 th run time of the PLC program running	10.0s 0.0~6500.0(s/m/h)

✧ ¶ F14.20: PLC 5th running time

Code (Addr.)	Name	Content	Factory setting (Setting range)
F14.20 (0x0E14) RUN	PLC 5 th stage running time	V/F SVC Set the 5 th run time of the PLC program running	10.0s 0.0~6500.0(s/m/h)

✧ ¶ F14.21: PLC 6th run time

Code (Addr.)	Name	Content	Factory setting (Setting range)
F14.21 (0x0E15) RUN	PLC 6 th stage running time	V/F SVC Set the 6 th run time of the PLC program running	10.0s 0.0~6500.0(s/m/h)

✧ ¶ F14.22: PLC 7th running time

Code (Addr.)	Name	Content	Factory setting (Setting range)
F14.22 (0x0E16) RUN	PLC 7 th stage running time	V/F SVC Set the 7 th run time of the PLC program running	10.0s 0.0~6500.0(s/m/h)

✧ ¶ F14.23: PLC 8th run time

Code (Addr.)	Name	Content	Factory setting (Setting range)
F14.23 (0x0E17) RUN	PLC 8 th stage running time	V/F SVC Set the 8 th run time of the PLC program running	10.0s 0.0~6500.0(s/m/h)

✧ ¶ F14.24: PLC 9th run time

Code (Addr.)	Name	Content	Factory setting (Setting range)

F14.24 (0x0E18) RUN	PLC 9 th stage running time	V/F SVC Set the 9 th run time of the PLC program running	10.0s 0.0~6500.0(s/m/h)
---------------------------	--	--	----------------------------

◇ ▮ F14.25: PLC 10th running time

Code (Addr.)	Name	Content	Factory setting (Setting range)
F14.25 (0x0E19) RUN	PLC 10 th stage running time	V/F SVC Set the 10 th run time of the PLC program running	10.0s 0.0~6500.0(s/m/h)

◇ ▮ F14.26: PLC 11th running time

Code (Addr.)	Name	Content	Factory setting (Setting range)
F14.26 (0x0E1A) RUN	PLC 11 th stage running time	V/F SVC Set the 11 th run time of the PLC program running	10.0s 0.0~6500.0(s/m/h)

◇ ▮ F14.27: PLC 12th run time

Code (Addr.)	Name	Content	Factory setting (Setting range)
F14.27 (0x0E1B) RUN	PLC 12 th stage running time	V/F SVC Set the 12 th run time of the PLC program running	10.0s 0.0~6500.0(s/m/h)

◇ ▮ F14.28: PLC 13th run time

Code (Addr.)	Name	Content	Factory setting (Setting range)
F14.28 (0x0E1C) RUN	PLC 13 th stage running time	V/F SVC Set the 13 th run time of the PLC program running	10.0s 0.0~6500.0(s/m/h)

◇ ▮ F14.29: PLC 14th run time

Code (Addr.)	Name	Content	Factory setting (Setting range)
F14.29 (0x0E1D) RUN	PLC 14 th stage running time	V/F SVC Set the 14 th run time of the PLC program running	10.0s 0.0~6500.0(s/m/h)

◇ ▮ F14.30: PLC 15th run time

Code (Addr.)	Name	Content	Factory setting (Setting range)
F14.30 (0x0E1E) RUN	PLC 15 th stage running time	V/F SVC Set the 15 th run time of the PLC program running	10.0s 0.0~6500.0(s/m/h)

F14.31-F14.45: PLC direction and acceleration/deceleration time selection

When the program is running, set the running direction and acceleration and deceleration time of 15 speeds respectively.

◇ ▮ F14.31: PLC first direction and acceleration and deceleration time

Code (Addr.)	Name	Content	Factory setting (Setting range)
F14.31 (0x0E1F) RUN	PLC first direction and acceleration and deceleration time	V/F SVC Used to set the 1st running direction and acceleration / deceleration time	0000 (0000~0031)

◇ ▮ F14.32: PLC second direction and acceleration and deceleration time

Code (Addr.)	Name	Content	Factory setting (Setting range)
F14.32 (0x0E20) RUN	PLC 2 nd direction and acceleration and deceleration time	V/F SVC Used to set the 2 nd running direction and acceleration / deceleration time	0000 (0000~0031)

◇ ▮ F14.33: PLC 3rd direction and acceleration and deceleration time

Code (Addr.)	Name	Content	Factory setting (Setting range)

F14.33 (0x0E21) RUN	PLC 3 rd direction and acceleration and deceleration time	V/F SVC Used to set the 3 rd running direction and acceleration / deceleration time	0000 (0000~0031)
---------------------------	--	---	---------------------

✧ ¶ F14.34: PLC direction 4 and acceleration and deceleration time

Code (Addr.)	Name	Content	Factory setting (Setting range)
F14.34 (0x0E22) RUN	PLC 4 th direction and acceleration and deceleration time	V/F SVC Used to set the 4 th running direction and acceleration / deceleration time	0000 (0000~0031)

✧ ¶ F14.35: PLC 5th direction and acceleration and deceleration time

Code (Addr.)	Name	Content	Factory setting (Setting range)
F14.35 (0x0E23) RUN	PLC 5 th direction and acceleration and deceleration time	V/F SVC Used to set the 5 th running direction and acceleration / deceleration time	0000 (0000~0031)

✧ ¶ F14.36: PLC 6th direction and acceleration and deceleration time

Code (Addr.)	Name	Content	Factory setting (Setting range)
F14.36 (0x0E24) RUN	PLC 6 th direction and acceleration and deceleration time	V/F SVC Used to set the 6 th running direction and acceleration / deceleration time	0000 (0000~0031)

✧ ¶ F14.37: PLC 7th direction and acceleration and deceleration time

Code (Addr.)	Name	Content	Factory setting (Setting range)
F14.37 (0x0E25) RUN	PLC 7 th direction and acceleration and deceleration time	V/F SVC Used to set the 7 th running direction and acceleration / deceleration time	0000 (0000~0031)

✧ ¶ F14.38: PLC 8th direction and acceleration and deceleration time

Code (Addr.)	Name	Content	Factory setting (Setting range)
F14.38 (0x0E26) RUN	PLC 8 th direction and acceleration and deceleration time	V/F SVC Used to set the 8 th running direction and acceleration / deceleration time	0000 (0000~0031)

✧ ¶ F14.39: PLC 9th direction and acceleration and deceleration time

Code (Addr.)	Name	Content	Factory setting (Setting range)
F14.39 (0x0E27) RUN	PLC 9 th direction and acceleration and deceleration time	V/F SVC Used to set the 9 th running direction and acceleration / deceleration time	0000 (0000~0031)

✧ ¶ F14.40: PLC 10th direction and acceleration and deceleration time

Code (Addr.)	Name	Content	Factory setting (Setting range)
F14.40 (0x0E28) RUN	PLC 10 th direction and acceleration and deceleration time	V/F SVC Used to set the 10 th running direction and acceleration / deceleration time	0000 (0000~0031)

✧ ¶ F14.41: PLC 11th direction and acceleration and deceleration time

Code (Addr.)	Name	Content	Factory setting (Setting range)
F14.41 (0x0E29) RUN	PLC 11 th direction and acceleration and deceleration time	V/F SVC Used to set the 11 th running direction and acceleration / deceleration time	0000 (0000~0031)

✧ ¶ F14.42: PLC 12th direction and acceleration and deceleration time

Code (Addr.)	Name	Content	Factory setting (Setting range)

F14.42 (0x0E2A) RUN	PLC 12 th direction and acceleration and deceleration time	V/F SVC Used to set the 12 th running direction and acceleration / deceleration time	0000 (0000-0031)
---------------------------	---	--	---------------------

✧ ¶ F14.43: PLC 13th direction and acceleration and deceleration time

Code (Addr.)	Name	Content	Factory setting (Setting range)
F14.43 (0x0E2B) RUN	PLC 13 th direction and acceleration and deceleration time	V/F SVC Used to set the 13 th running direction and acceleration / deceleration time	0000 (0000-0031)

✧ ¶ F14.44: PLC 14th direction and acceleration and deceleration time

Code (Addr.)	Name	Content	Factory setting (Setting range)
F14.44 (0x0E2C) RUN	PLC 14 th direction and acceleration and deceleration time	V/F SVC Used to set the 14 th running direction and acceleration / deceleration time	0000 (0000-0031)

✧ ¶ F14.45: PLC 15th direction and acceleration and deceleration time

Code (Addr.)	Name	Content	Factory setting (Setting range)
F14.45 (0x0E2D) RUN	PLC 15 th direction and acceleration and deceleration time	V/F SVC Used to set 15 th the running direction and acceleration / deceleration time	0000 (0000-0031)

Unit position: the direction of this paragraph

0: positive

1: reverse

Ten digits: acceleration and deceleration time of this section

0: Acceleration/deceleration time 1

1: acceleration and deceleration time 2

2: Acceleration and deceleration time 3

3: Acceleration and deceleration time 4

Hundreds: reserved

Thousands: reserved

Revised record

Issue date	Revised number	Change content
April 24, 2019	V0.0	Original Issue